



Hemostatic Forceps 08

08 Hemostatics Forceps

| | | | |
|-------------------------------|---------------------|-------------------------|---------|
| Adson | 111 | Moynihan | 137 |
| Adson-Baby | 118 | Negus | 133 |
| Backhaus | 139 | Obwegeser | 102 |
| Bengolea | 114 | Organ Grasping Forceps | 110 |
| Bernhard | 140 | Orgen-Grasping | 109 |
| Bozemann | 147,150 | Overholt | 122 |
| Carfoord | 119 | Overholt-Baby | 105 |
| Chaput | 109 | Overholt-Fino | 121 |
| Cheron | 147 | Overholt-Geissendorfer | 120 |
| Collin | 110,147 | Overholt-Martin | 117 |
| Crile | 104,105 | Overholt-Mini | 122 |
| Crile-Rankin | 101 | Overholt-Mixer | 118 |
| Dandy | 101 | Pean | 108,112 |
| Dandy-Mosquito | 101 | Pean (Rochester) | 115 |
| Dasjardins | 131 | Pean-Nippon | 113 |
| Dissecting & Ligature Forceps | 117,129,132 | Peers-Bertram | 141 |
| Dressing Forceps | 144-147 | Peers-Bertram Modif | 140 |
| Faure | 138 | Pennington | 110 |
| Finochietto | 128 | Periosteal Elevators | 102 |
| Fletcher (Javerts) | 150 | Phaneuf | 134 |
| Foerster | 148,149 | Plaster Spreaders | 130 |
| Gemini | 123 | Pratt | 110 |
| Gross-Maier | 146 | Providence-Hospital | 107 |
| Guyon | 130,131 | Rampley | 149 |
| Halsted-Mosquito | 103 | Roberts | 119 |
| Hartmann | 106 | Rochester-Carmalt | 111 |
| Hemostatics Forceps | 101,103-109,111-116 | Roder | 140 |
| Heaney | 134 | Rogers | 135 |
| Heiss | 118 | Rowe | 102 |
| Hysterotomy Forceps | 133-138 | Rumel | 121 |
| Jones | 139 | Sarot | 119 |
| Jones-Martin | 139 | Schadel | 139 |
| Kelly | 104,107,129 | Schnidt | 111 |
| Kelly-Rankin | 105 | Spencer-Wells | 108 |
| Kidney Pedical Clamps | 131 | Spong Forceps | 148-149 |
| Kocher | 112 | Tiffier | 109 |
| Kicher- (Ochsner) | 116 | Tohoku | 141 |
| Kocher (Nippon) | 113 | Towel Clamp | 139-141 |
| Lahey | 127 | Tubing Clamp | 142,143 |
| Lane | 141 | Ulrich | 144 |
| Lawrence | 132 | Uro-Tangential | 128 |
| Leriche | 107 | Utrain Dressing Forceps | 150 |
| Lister | 145 | Wertheim | 136,137 |
| Lovelace | 101 | Wertheim-Cullen | 133 |
| Lower | 127 | Wickstrom | 126 |
| Martel-Rees | 110 | Zenker | 124 |
| Martin | 145 | | |
| Martin-Fuchsig | 111 | | |
| Mc Quigg-Mixer | 127 | | |
| Meeker | 132 | | |
| Mershon | 102 | | |
| Mikro-Mosquito | 103 | | |
| Mikulicz | 136,138 | | |
| Mikulicz, Baby | 136 | | |
| Mini-Gemini | 123 | | |
| Mixer | 125,126 | | |
| Mixer-Baby | 106,118,124 | | |
| Mixer-o'Shaugnessy | 125 | | |

Haemostatic Forceps
Pinzas hemostáticas
Pincès hemostatiques

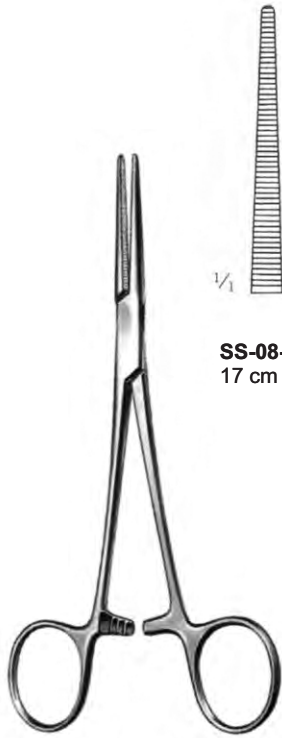

SS-08-101
17 cm / 6³/₄"



SS-08-102
17 cm / 6³/₄"



SS-08-103
17 cm / 6³/₄"



SS-08-104
17 cm / 6³/₄"



Crile-Rankin

Lovelace

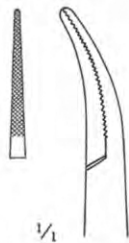
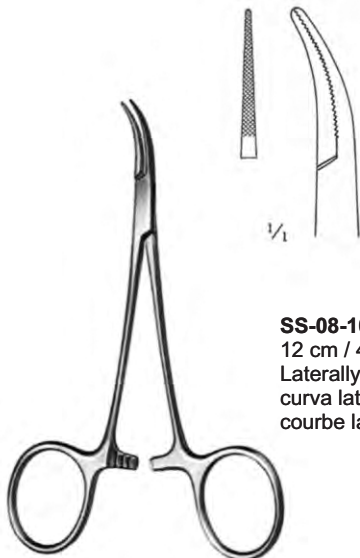

SS-08-105
12 cm / 4³/₄"
Laterally curved
curva lateralmente
courbe lateralment

Dandy-Mosquito

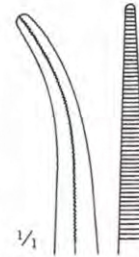

SS-08-106
14.5 cm / 5³/₄"
Laterally curved
Curva lateralmente
courbe lateralment

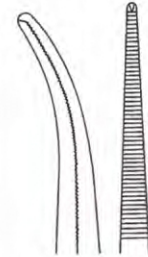

SS-08-107
14.5 cm / 5³/₄"
Laterally curved
Curva lateralmente
courbe lateralment











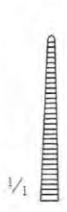

Dandy

Haemostatic Forceps
 Pinzas hemostáticas
 Pincas hemostatiques

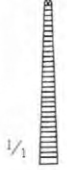
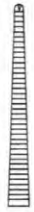

$\frac{1}{2}$







Halsted-Mosquito

| | | | |
|--|--|---|--|
|  |  |  |  |
| SS-08-108 12.5 cm / 5" | SS-08-109 14.5 cm / 5¾" | SS-08-110 12 cm / 4¾" | SS-08-111 14 cm / 5½" |
|  |  |  |  |
| SS-08-112 12.5 cm / 5" | SS-08-113 14.5 cm / 5¾" | SS-08-114 12 cm / 4¾" | SS-08-115 14 cm / 5½" |
|  1:2 |  1:2 |  1:2 |  1:2 |

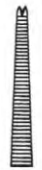

$\frac{1}{2}$

Halsted-Mosquito

| | | | |
|---|--|---|---|
|  |  |  |  |
| SS-08-116 12.5 cm / 5" | SS-08-117 12 cm / 4¾" | SS-08-118 12 cm / 4¾" | SS-08-119 12 cm / 4¾" |
|  1:2 |  1:2 |  1:2 | |

Haemostatic Forceps
Pinzas hemostáticas
Pincers hemostatiques



Halsted-Mosquito



SS-08-120
18.5 cm / 7¼"



SS-08-121
18 cm / 7"



SS-08-122
18.5 cm / 7¼"



1:2



SS-08-123
18 cm / 7"



1:2

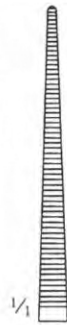

SS-08-124
21 cm / 8¼"



SS-08-125
20.5 cm / 8"



SS-08-126
21 cm / 8¼"



1:2



SS-08-127
20.5 cm / 8"



1:2



Mikro-Mosquito



SS-08-128
10 cm / 4"



SS-08-129
12 cm / 4¾"



SS-08-130
9.5 cm / 3¾"



SS-08-131
11.5 cm / 4½"

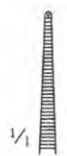

SS-08-132
10 cm / 4"



1:2

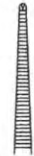

SS-08-133
12 cm / 4¾"



1:2



SS-08-134
10 cm / 4"



1:2



SS-08-135
12 cm / 4¾"



1:2



SAPTESTAR
Manufacturer & Exporter Of Surgical, Dental & Veterinary Instruments

Haemostatic Forceps
Pinzas hemostáticas
Pinces hemostatiques



Kelly



- SS-08-500 16 cm / 6 1/4"
- SS-08-501 18 cm / 7"
- SS-08-502 20 cm / 8"
- SS-08-503 23 cm / 9"
- SS-08-504 25 cm / 10"



- SS-08-510 16 cm / 6 1/4"
- SS-08-511 18 cm / 7"
- SS-08-512 20 cm / 8"
- SS-08-513 23 cm / 9"
- SS-08-514 25 cm / 10"



- SS-08-520 16 cm / 6 1/4"
- SS-08-521 18 cm / 7"
- SS-08-522 20 cm / 8"
- SS-08-523 23 cm / 9"
- SS-08-524 25 cm / 10"

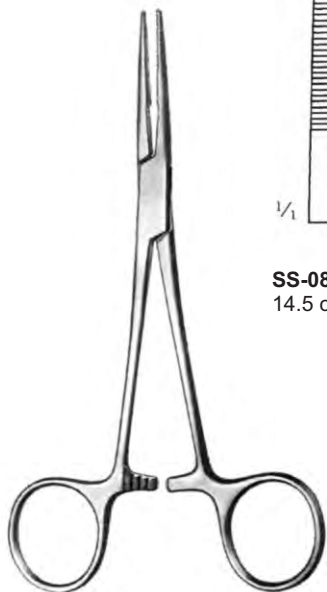

Kelly

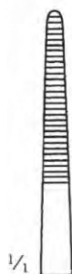

- SS-08-136
14.5 cm / 5 3/4"



- SS-08-137
14 cm / 5 1/2"



Crile



- SS-08-138
14.5 cm / 5 3/4"



- SS-08-139
14 cm / 5 1/2"

Haemostatic Forceps
Pinzas hemostáticas
Pinces hemostatiques



½ **Kelly-Rankin**



SS-08-140
16 cm / 6¼"



SS-08-141
15.5 cm / 6"



SS-08-142
14 cm / 5½"



½ **Overholt-Baby**

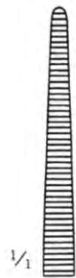

SS-08-143
14.5 cm / 5¾"



SS-08-144
14 cm / 5½"

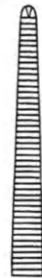

SS-08-145
20.5 cm / 8"



SS-08-146
20.5 cm / 8"



1:2



1:2



½ **Crile**

Haemostatic Forceps
Pinzas hemostáticas
Pincers hemostatiques

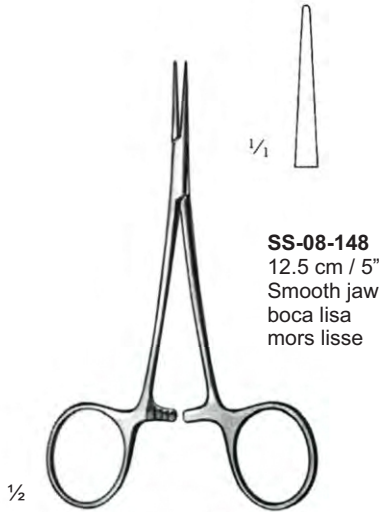

SS-08-148
12.5 cm / 5"
Smooth jaw
boca lisa
mors lisse

Ligature forceps
Pinza para hilos
Pince a ligatures



SS-08-149
13.5 cm / 5 1/4"



SS-08-150
13 cm / 5"

Mixer-Baby



SS-08-151
10 cm / 4"

Hartmann



SS-08-152
9.5 cm / 3 3/4"



SS-08-153
12.5 cm / 5"
Cross serrated jaw
boca estriada en forma de cruz
mors a rainures croisees

Ligature forceps
Pinza para hilos
Pince a ligatures

Haemostatic Forceps
Pinzas hemostáticas
Pincas hemostatiques



SS-08-154
14 cm / 5 1/2"



SS-08-155
14 cm / 5 1/2"



SS-08-156
15.5 cm / 6"



SS-08-157
15 cm / 6"



SS-08-158
15.5 cm / 6"



SS-08-159
15 cm / 6"

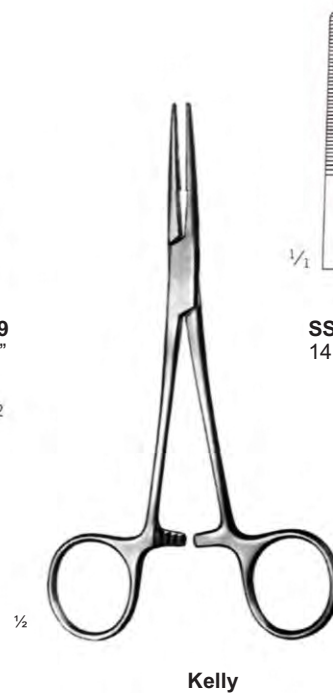

SS-08-160
14.5 cm / 5 3/4"



SS-08-161
14 cm / 5 1/2"



SAPTESTAR
Manufacturer & Exporter Of Surgical, Dental & Veterinary Instruments

Haemostatic Forceps
Pinzas hemostaticas
Pincas hemostatiques



1/2

Pean



1/1

SS-08-162
14.5 cm / 5 3/4"



SS-08-163
16 cm / 6 1/4"

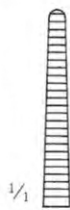

1/1

SS-08-164
13 cm / 5"



SS-08-165
14 cm / 5 1/2"

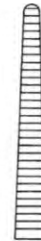

SS-08-166
15.5 cm / 6"



SS-08-167
18.5 cm / 7 1/4"

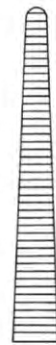

SS-08-168
20 cm / 8"



1/2

Spencer-Wells



1/1

SS-08-169
13 cm / 5"



SS-08-170
14 cm / 5 1/2"



SS-08-171
15 cm / 6"



SS-08-172
18 cm / 7"



SS-08-173
20 cm / 8"

Haemostatic Forceps
Pinzas hemostaticas
Pincers hemostatiques



Atrauma



SS-08-176
25 cm / 9 3/4"



SS-08-177
26 cm / 10 1/4"

Organ-Grasping



SAPTESTAR
Manufacturer & Exporter Of Surgical, Dental & Veterinary Instruments

Organ Grasping Forceps
Pinzas para sacar organ
Pinces pour saisir des organes



SS-08-178
14 cm / 5½"

Collin



SS-08-179
17 cm / 6¾"

Collin

Tumor grasping forceps
Pinzas para sacar organ
Pinces a tumeurs avis



SS-08-180
15.5 cm / 6"

Bennington

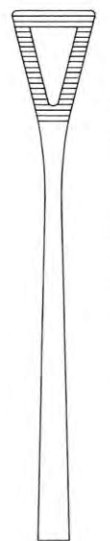

SS-08-181
21 cm / 8¼"



SS-08-182
15 cm / 6"

Pratt



SS-08-183
13.5 cm / 5¼"

Martel-Rees

Face lift forceps
Pinza para Face-Lift
Pinces pour Face-lift

Haemostatic Forceps
Pinzas hemostaticas
Pincas hemostatiques



SS-08-184
18,5 cm / 7¼"



SS-08-185
19 cm / 7½"



SS-08-186
19 cm / 7½"



SS-08-187
18.5 cm / 7¼"

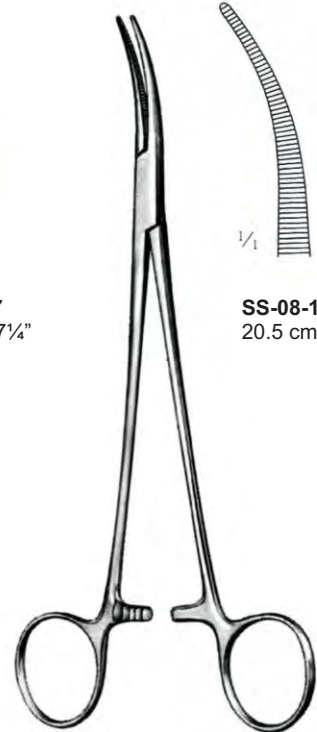

SS-08-188
20.5 cm / 8"

Schnidt

Adson

Martin-Fuchsig



Rochester-Carmalt



SS-08-189
17 cm / 6¾"



SS-08-190
20.5 cm / 8"



SS-08-191
16.5 cm / 6½"



SS-08-192
20 cm / 8"

Haemostatic Forceps
 Pinzas hemostaticas
 Pincas hemostatiques

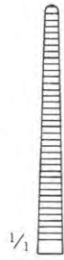

SS-08-193
 13.5 cm / 5¼"



SS-08-194
 14.5 cm / 5¾"



SS-08-195
 17 cm / 6¾"



SS-08-196
 13 cm / 5"



SS-08-197
 14 cm / 5½"

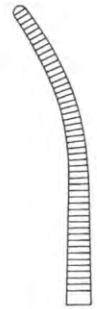

SS-08-198
 16.5 cm / 6½"

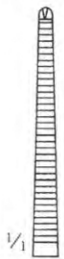
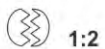

SS-08-199
 13 cm / 5"



SS-08-200
 14 cm / 5½"



SS-08-201
 16 cm / 6¼"



SS-08-202
 13 cm / 5"



SS-08-203
 14 cm / 5½"



SS-08-204
 16 cm / 6¼"

Haemostatic Forceps
Pinzas hemostaticas
Pincas hemostatiques



Pean-Nippon

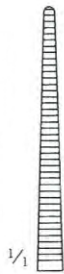

SS-08-205
14.5 cm / 5¾"



SS-08-206
16.5 cm / 6½"



SS-08-207
18.5 cm / 7¼"



SS-08-208
14 cm / 5½"



SS-08-209
16 cm / 6¼"



SS-08-210
18 cm / 7"



Kocher-Nippon

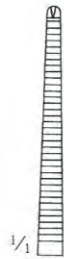

SS-08-211
14.5 cm / 5¾"



SS-08-212
16.5 cm / 6½"



SS-08-213
18.5 cm / 7¼"



SS-08-214
14.5 cm / 5½"



SS-08-215
16 cm / 6¼"



SS-08-216
18 cm / 7"

½



Haemostatic Forceps
 Pinzas hemostaticas
 Pincas hemostatiques

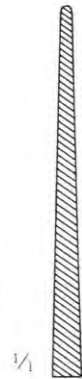

SS-08-217
 21.5 cm / 8½"



SS-08-218
 21 cm / 8¼"



SS-08-219
 21.5 cm / 8½"



SS-08-220
 21 cm / 8¼"



Bengolea



SS-08-221
 26 cm / 10¼"



SS-08-222
 25.5 cm / 10"



SS-08-223
 26 cm / 10¼"



SS-08-224
 25.5 cm / 10"

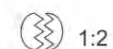

Haemostatic Forceps
Pinzas hemostaticas
Pincers hemostatiques

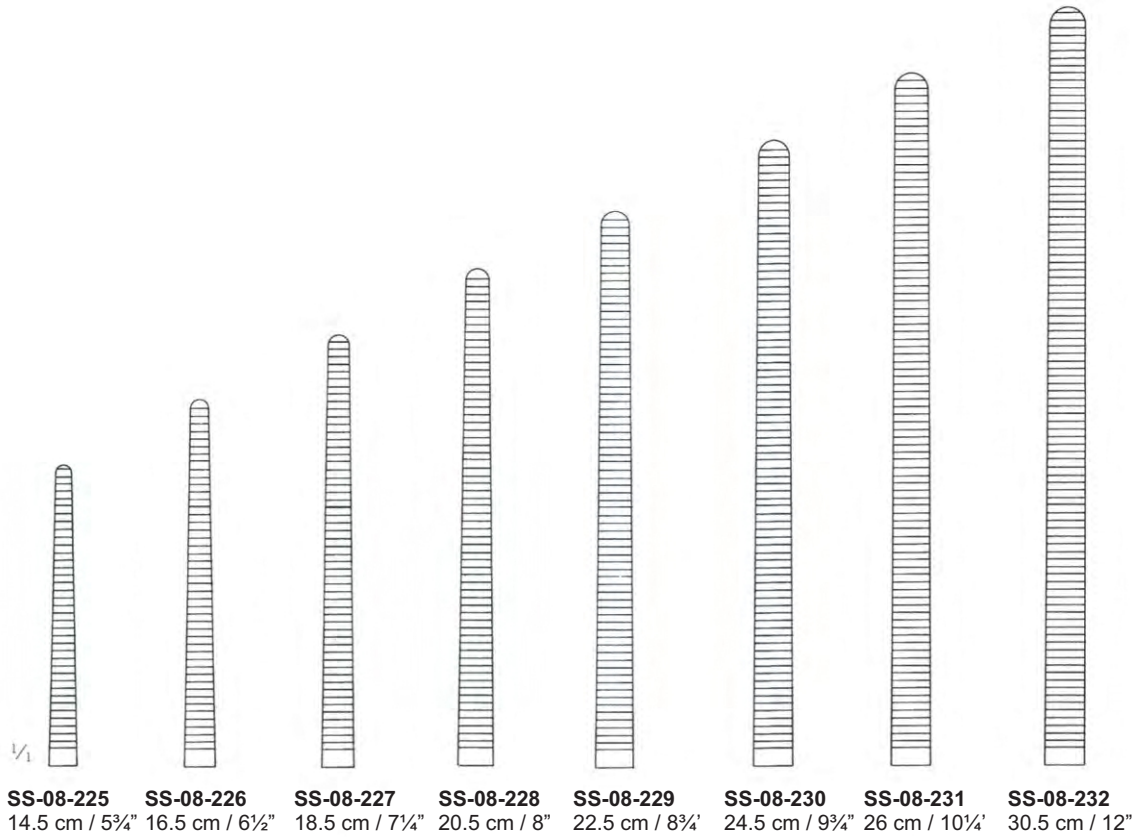

Pean (Rochester)

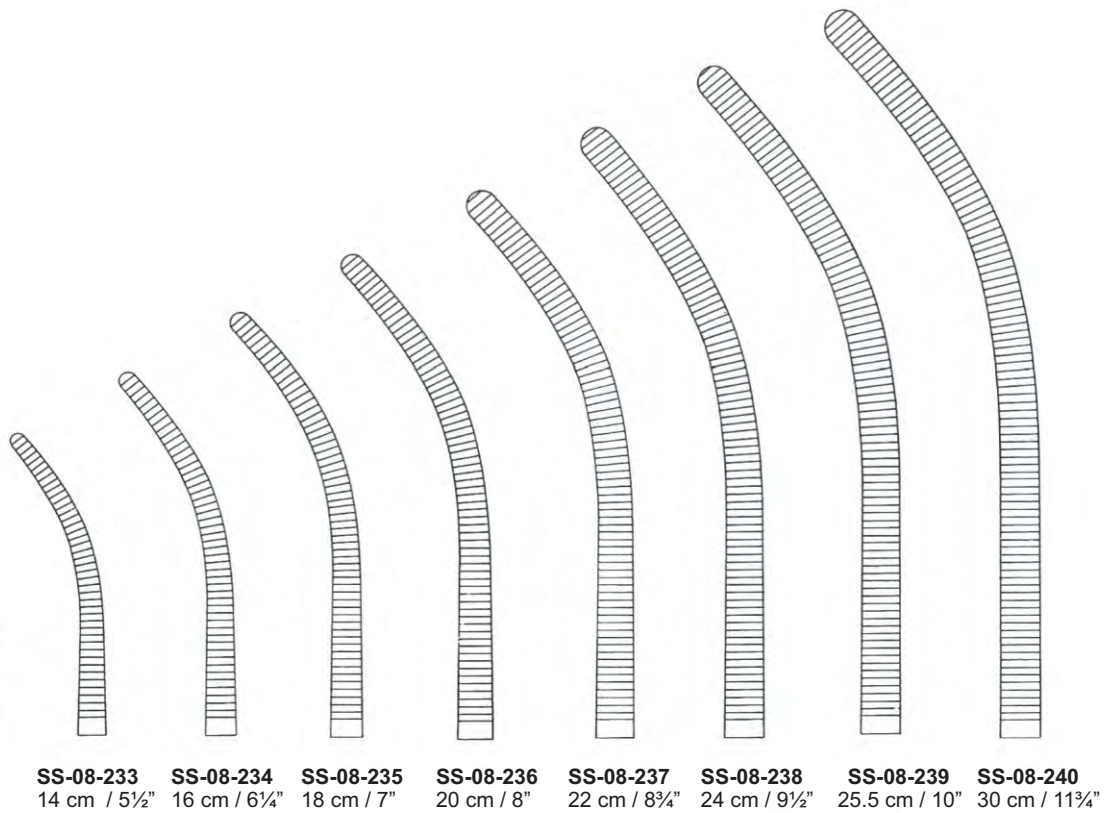



SAPTESTAR
Manufacturer & Exporter Of Surgical, Dental & Veterinary Instruments

Haemostatic Forceps
Pinzas hemostaticas
Pinces hemostatiques

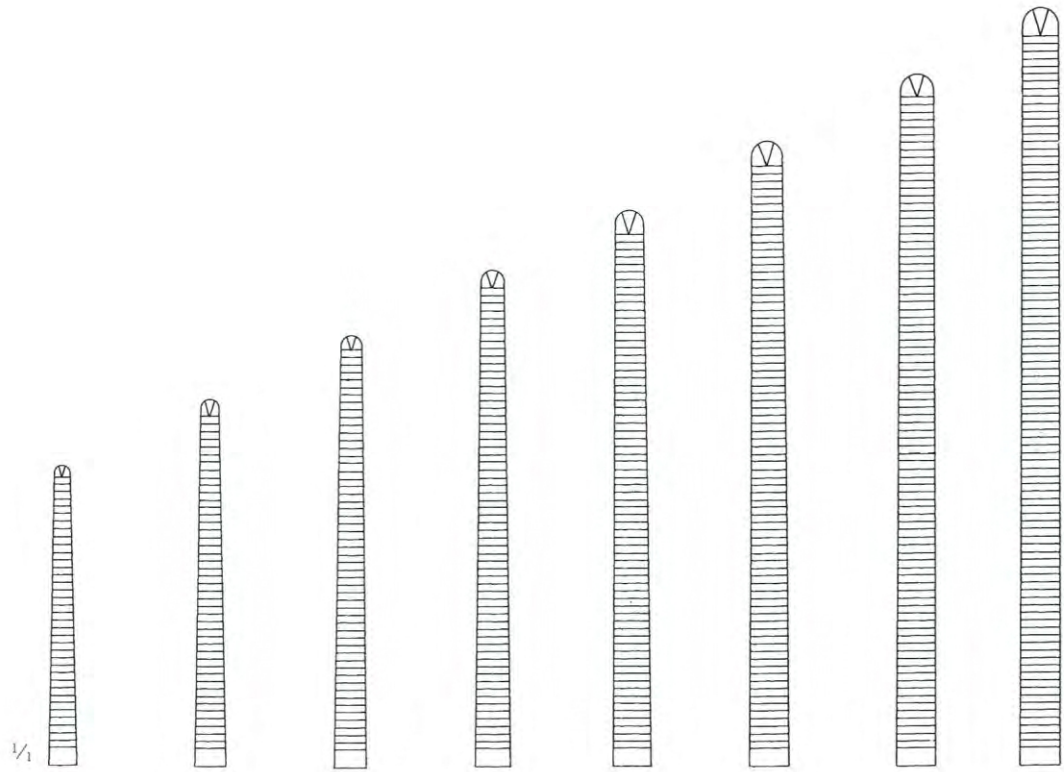

| | | | | | | | |
|------------------|------------------|------------------|------------------|------------------|------------------|------------------|------------------|
| SS-08-241 | SS-08-242 | SS-08-243 | SS-08-244 | SS-08-245 | SS-08-246 | SS-08-247 | SS-08-248 |
| 14.5 cm / 5¾" | 16.5 cm / 6½" | 18.5 cm / 7¼" | 20.5 cm / 8" | 22.5 cm / 8¾" | 24.5 cm / 9¾" | 26 cm / 10¼" | 30.5 cm / 12" |



Kocher (Ochsner)



1:2

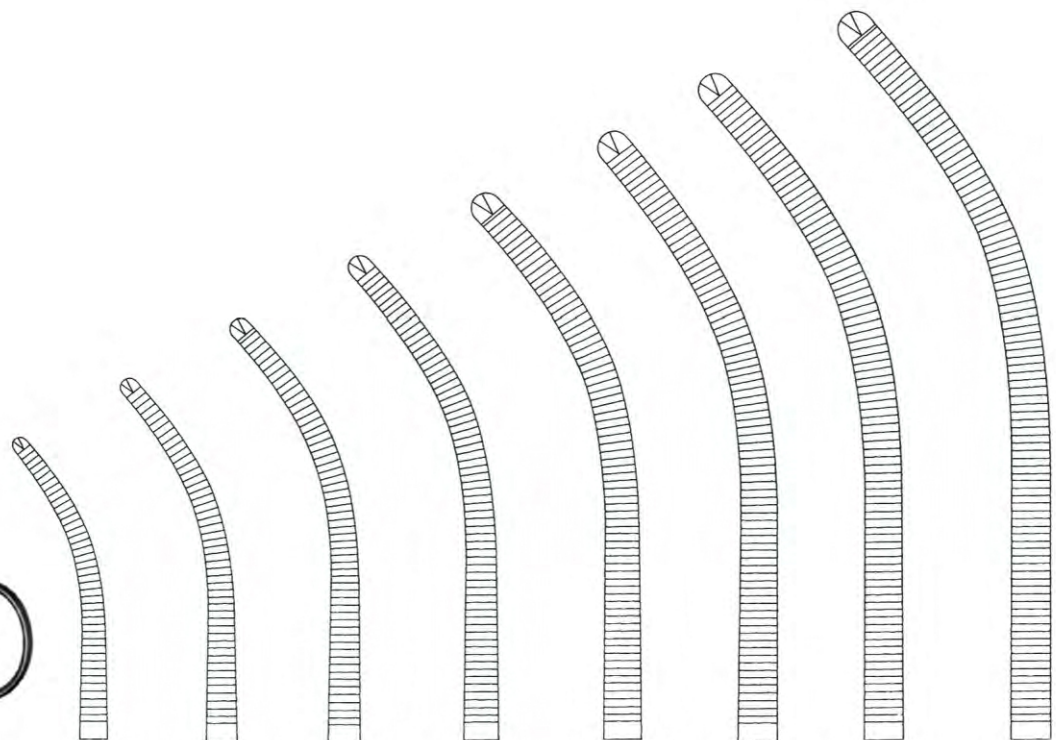

| | | | | | | | |
|------------------|------------------|------------------|------------------|------------------|------------------|------------------|------------------|
| SS-08-249 | SS-08-250 | SS-08-251 | SS-08-252 | SS-08-253 | SS-08-254 | SS-08-255 | SS-08-256 |
| 14 cm / 5½" | 16 cm / 6¼" | 18 cm / 7" | 20 cm / 8" | 22 cm / 8¾" | 24 cm / 9½" | 25.5 cm / 10" | 30 cm / 11¾" |



Overholt-Martin

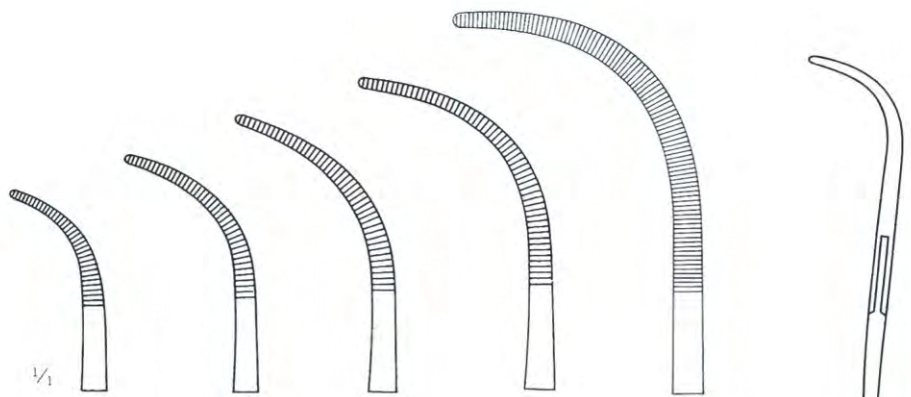

SS-08-257
18.5 cm / 7¼"
Fig. 1

SS-08-258
20.5 cm / 8"
Fig. 2

SS-08-259
21 cm / 8¼"
Fig. 3

SS-08-260
21.5 cm / 8½"
Fig. 4

SS-08-261
24.5 cm / 9¾"
Fig. 5



Dissecting and Ligature Forceps
 Pinzas para preparación y ligadura
 Pinces per preparazioni e legature



SS-08-262
 18.5 cm / 7 $\frac{1}{4}$ "

Mixer-Baby



SS-08-263
 14.5 cm / 5 $\frac{3}{4}$ "



SS-08-264
 18 cm / 7"

Adson-Baby

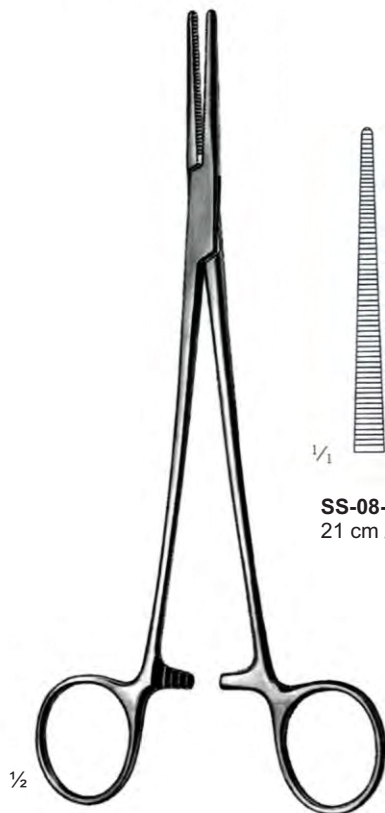

SS-08-265
 21 cm / 8 $\frac{1}{4}$ "

Heiss



SS-08-266
 20.5 cm / 8"



SS-08-267
 20 cm / 8"



SS-08-268
 21.5 cm / 8 $\frac{1}{2}$ "

Overholt-Mixer





SAPTESTAR
Manufacturer & Exporter Of Surgical, Dental & Veterinary Instruments

Dissecting and Ligature Forceps
Pinzas para preparación y ligadura
Pinces per preparazioni e legature

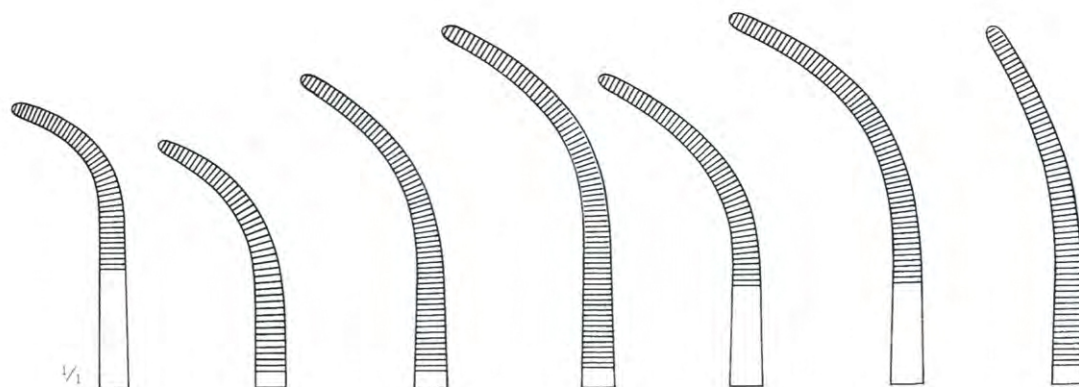

SS-08-275
20.5 cm / 8"
Fig. 1

SS-08-276
20 cm / 8"
Fig. 2

SS-08-277
21.5 cm / 8½"
Fig. 3

SS-08-278
22 cm / 8¾"
Fig. 4

SS-08-279
21.5 cm / 8½"
Fig.5

SS-08-280
22 cm / 8¾"
Fig. 6

SS-08-281
22 cm / 8¾"
Fig. 7

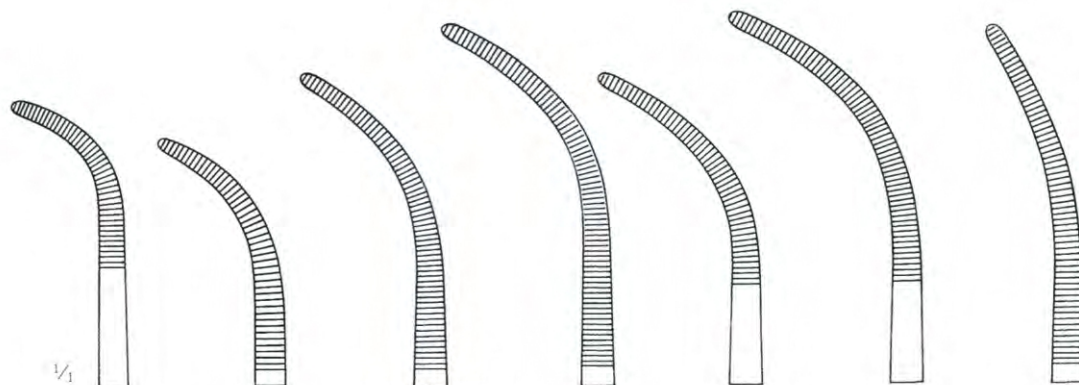

SS-08-282
27 cm / 10¾"
Fig. 1

SS-08-283
26.5 cm / 10½"
Fig. 2

SS-08-284
27.5 cm / 10¾"
Fig. 3

SS-08-285
28 cm / 11"
Fig. 4

SS-08-286
27.5 cm / 10¾"
Fig. 5

SS-08-287
28 cm / 11"
Fig. 6

SS-08-288
27.5 cm / 10¾"
Fig. 7



Overholt-Geissendorfer

Dissecting and Ligature Forceps
Pinzas para preparación y ligadura
Pinces per preparazioni e legature



Overholt-Fino



SS-08-289
21.5 cm / 8½"

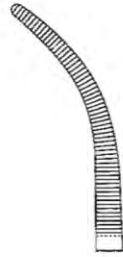

SS-08-290
21 cm / 8½"



SS-08-291
22 cm / 8½"



SS-08-292
23 cm / 9"



SS-08-293
22.5 cm / 8¾"



Rumel

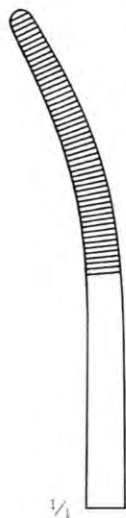

SS-08-294
24 cm / 9½"



SS-08-295
23.5 cm / 9¼"

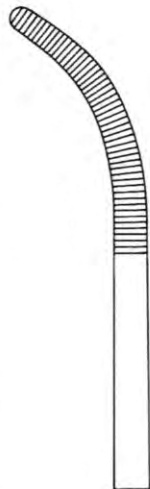

SS-08-296
23 cm / 9"



SS-08-297
24 cm / 9½"

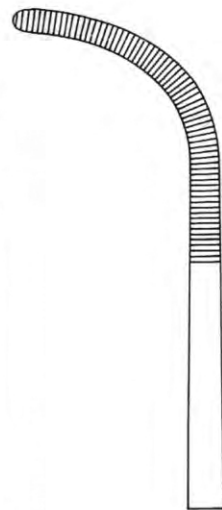

SS-08-298
23.5 cm / 9¼"

Dissecting and Ligature Forceps
 Pinzas para preparación y ligadura
 Pincas per preparazioni e legature

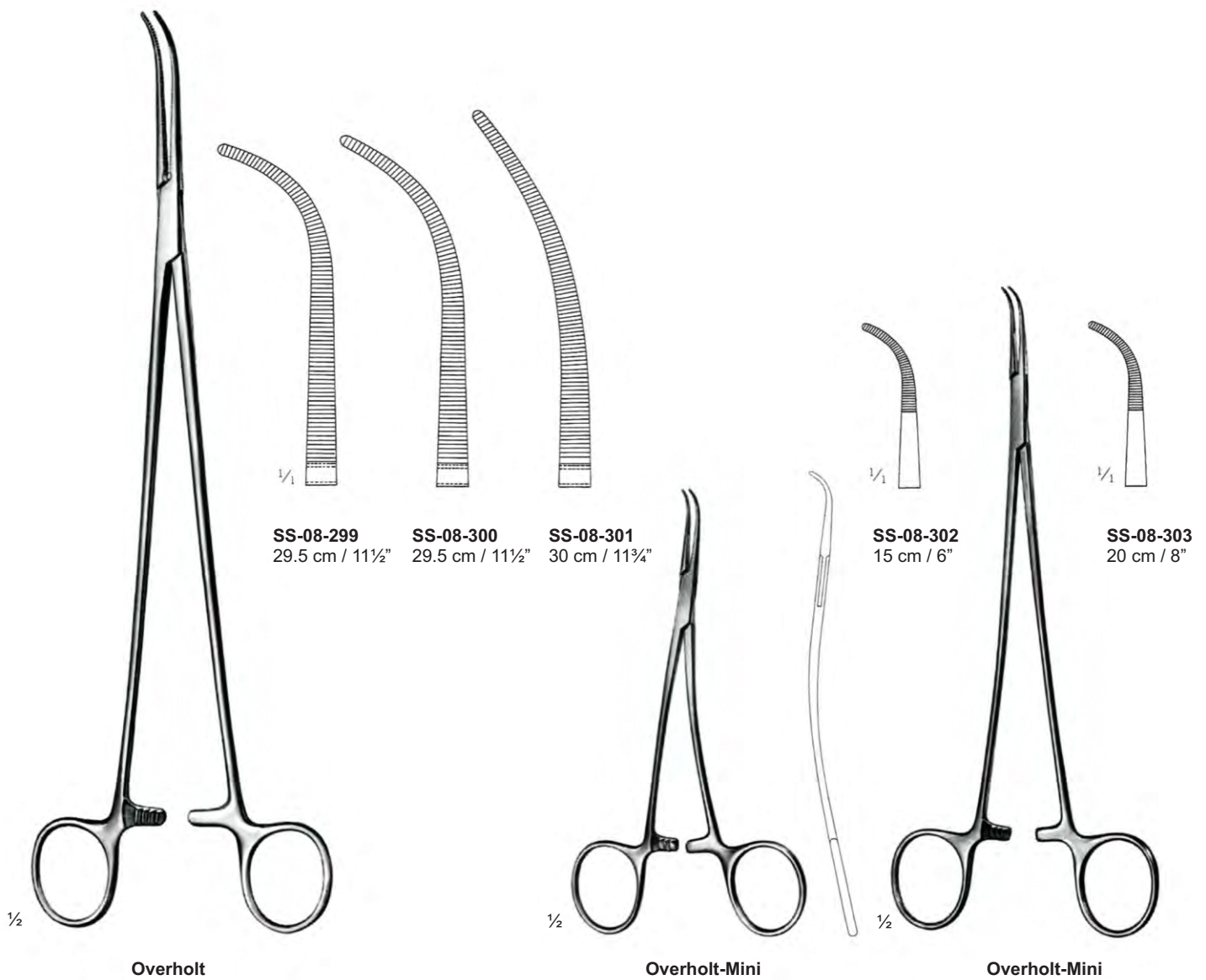

Dissecting and Ligature Forceps
Pinzas para preparación y ligadura
Pinces para preparazioni e legature



Mini-Gemini

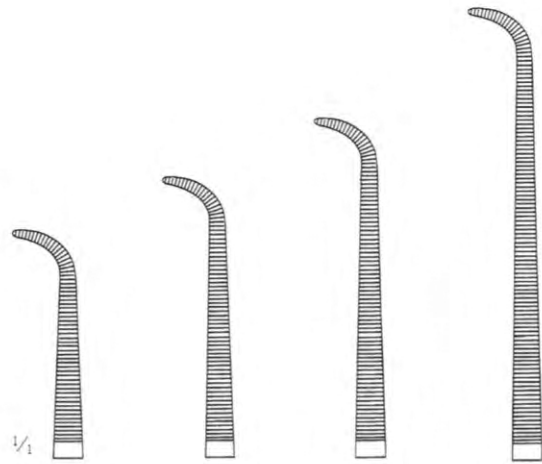

SS-08-304
18 cm / 7"

SS-08-305
22.5 cm / 8¾"

SS-08-306
25 cm / 9¾"

SS-08-307
28.5 cm / 11¼"



Gemini

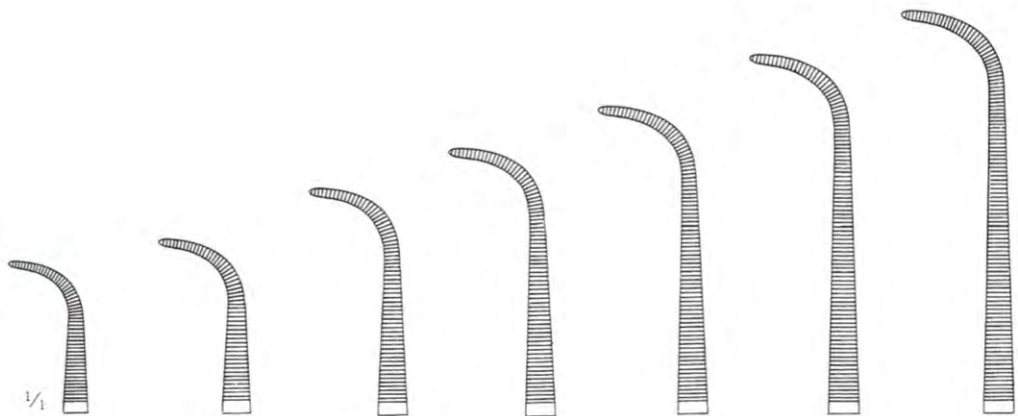

SS-08-308
13 cm / 5"

SS-08-309
16 cm / 6¼"

SS-08-310
18 cm / 7"

SS-08-311
21 cm / 8¼"

SS-08-312
23cm / 9"

SS-08-313
25 cm / 9¾"

SS-08-314
28 cm / 11"

Dissecting and Ligature Forceps
Pinzas para preparación y ligadura
Pinces per preparazioni e legature



Zenker



SS-08-315
29.5 cm / 11½"

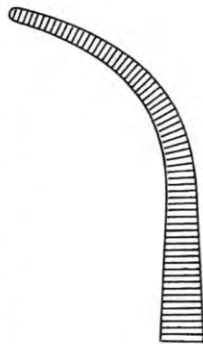

SS-08-316
28.5 cm / 11¼"



Mixer-Baby



SS-08-317
13.5 cm / 5¼"

Dissecting and Ligature Forceps
Pinzas para preparación y ligadura
Pinces per preparazioni e legature



1/2

Mixer

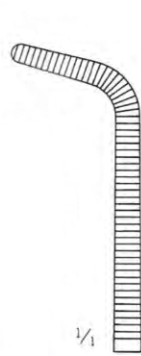

1/1

SS-08-318
16 cm / 6 1/4"

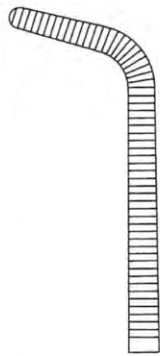

SS-08-319
18 cm / 7"



1/2

Mixer-O'Shaugnessy



1/1

SS-08-320
18 cm / 7"



1/2

Mixer



1/1

SS-08-321
22.5 cm / 8 3/4"



1/2

Mixer



1/1

SS-08-322
23 cm / 9"

Dissecting and Ligature Forceps
Pinzas para preparación y ligadura
Pinces per preparazioni e legature



Dissecting and Ligature Forceps
Pinzas para preparación y ligadura
Pinces per preparazioni e legature



Mc Quigg-Mixer

SS-08-328
23.5 cm / 9¼"



Lower

SS-08-329
18.5 cm / 7¼"



Lahey

SS-08-330
19.5 cm / 7¾"

SS-08-331
22.5 cm / 8¾"

Dissecting and Ligature Forceps
Pinzas para preparación y ligadura
Pinces per preparazioni e legature

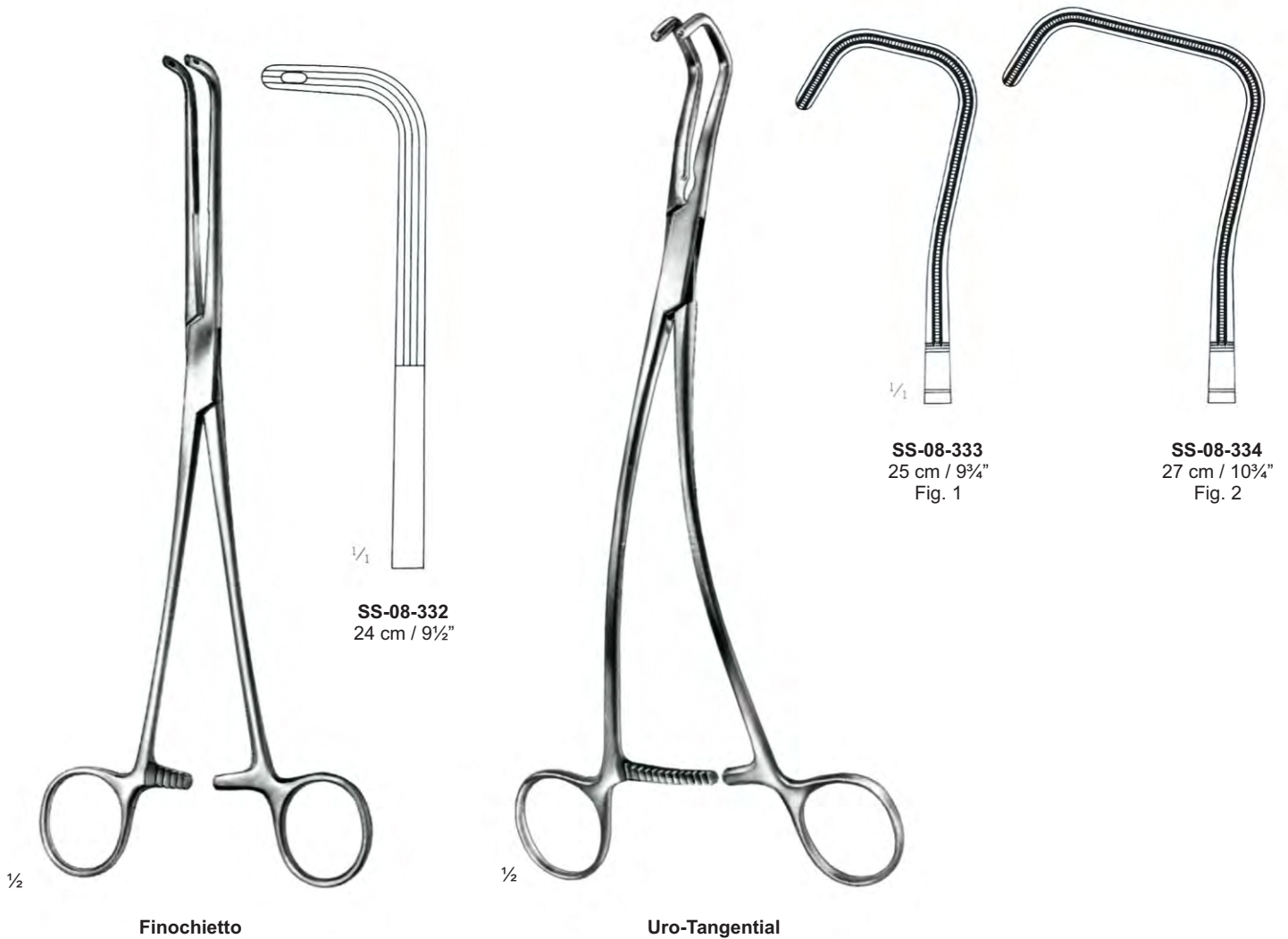

Dissecting and Ligature Forceps Pinzas para preparación y ligadura Pinces per preparazioni e legature

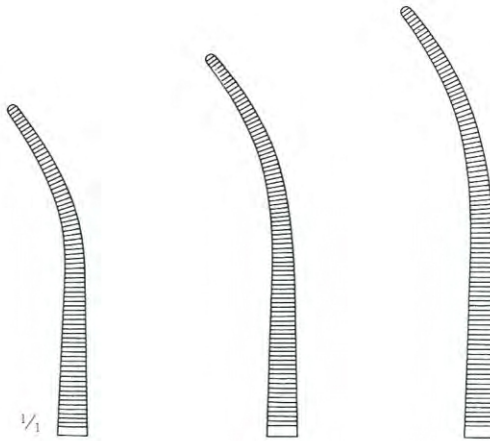

SS-08-335
19.5 cm / 7³/₄"
Fig. 1

SS-08-336
22.5 cm / 8³/₄"
Fig. 1

SS-08-337
24.5 cm / 9³/₄"
Fig. 1

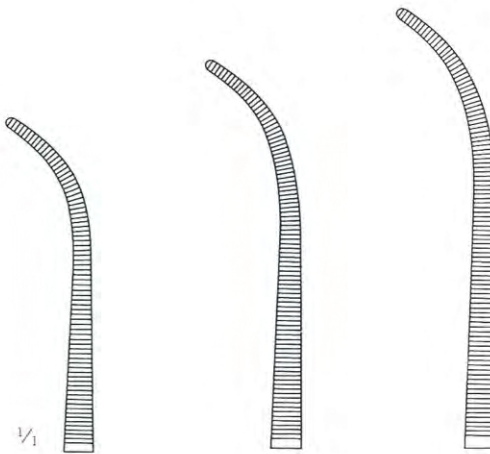

SS-08-338
19 cm / 7¹/₂"
Fig. 2

SS-08-339
22 cm / 8³/₄"
Fig. 2

SS-08-340
24cm / 9¹/₂"
Fig. 2



Kelly

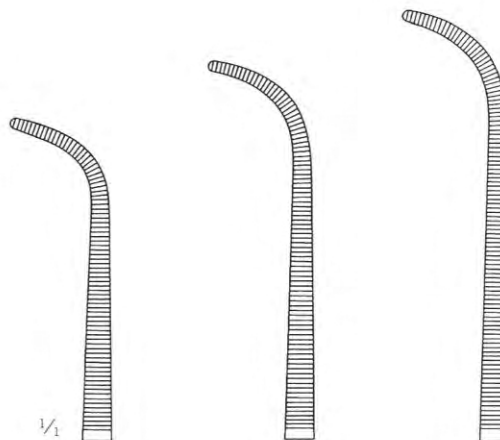

SS-08-341
18.5 cm / 7¹/₄"
Fig.3

SS-08-342
21.5 cm / 8¹/₂"
Fig. 3

SS-08-343
23.5 cm / 9¹/₄"
Fig. 3

Plaster Spreaders
Separadores para escayolas
Pinces ecartantes a platre



Kidney Pedicle Clamps
 Pinzas para pediculo renal
 Pinces-clamps pour pedicules renaux

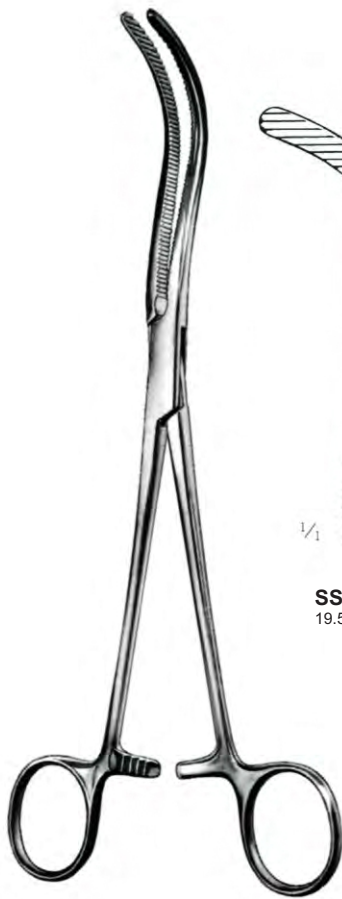

1/2

Guyon



1/4

SS-08-347
 19.5 cm / 7 3/4"

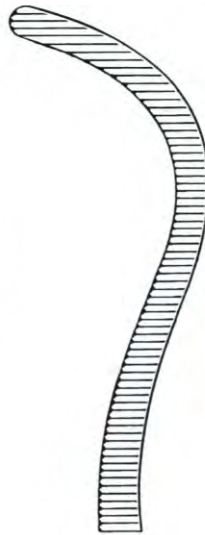

SS-08-348
 21.5 cm / 8 1/2"



SS-08-349
 24 cm / 9 1/2"



1/2

Desjardins

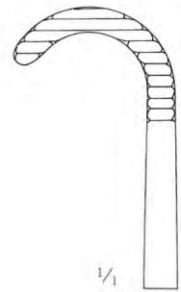

1/4

SS-08-350
 21 cm / 8 1/4"

Dissecting and Ligature Forceps
Pinzas para preparación y ligadura
Pinces per preparazioni e legature



Haemostatic Forceps
 Pinzas hemostaticas
 Pinces hemostatiques



Wertheim-Cullen

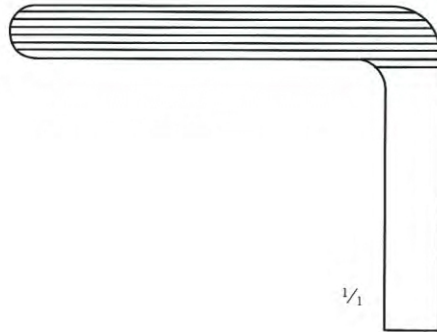

1/1

SS-08-353
 21 cm / 8 1/4"



Negus

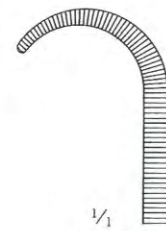

1/1

SS-08-354
 19.5 cm / 7 3/4"
 Fig. 1



SS-08-355
 20 cm / 8"
 Fig. 2



SAPTESTAR
Manufacturer & Exporter Of Surgical, Dental & Veterinary Instruments

Hysterectomy Forceps Pinzas para histerectomía Pincas a hysterectomie



Phaneuf



SS-08-356
20.5 cm / 8"

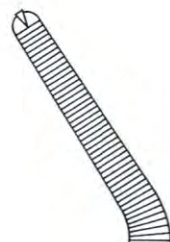

SS-08-357
20 cm / 8"

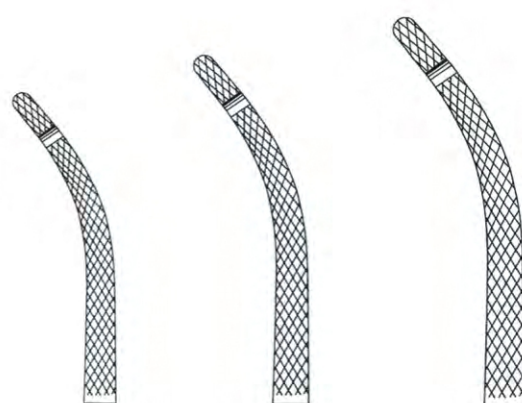

SS-08-358
19.5 cm / 7¾"
Fig. 1

SS-08-359
21.5 cm / 8½"
Fig. 1

SS-08-360
24 cm / 9½"
Fig. 1



Heaney

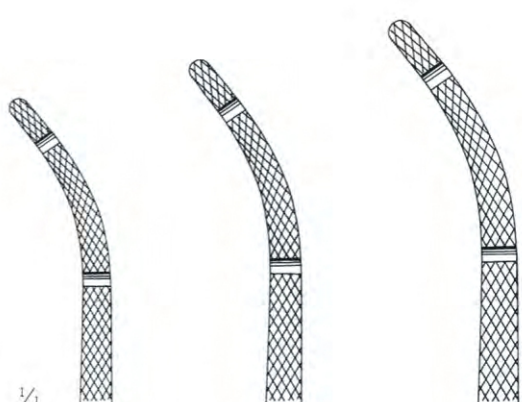

SS-08-361
19.5 cm / 7¾"
Fig. 2

SS-08-362
21.5 cm / 8¼"
Fig. 2

SS-08-363
24 cm / 9½"
Fig. 2

Hysterectomy Forceps
Pinzas para histerectomía
Pincas a histerectomie



Rogers



SS-08-364
21.5 cm / 8½"
Fig. 1



SS-08-365
21 cm / 8¼"
Fig. 2



SS-08-366
20.5 cm / 8"
Fig. 3

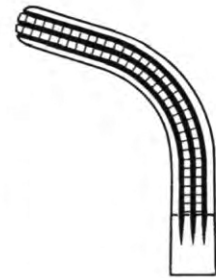

SS-08-367
20 cm / 8"
Fig. 4

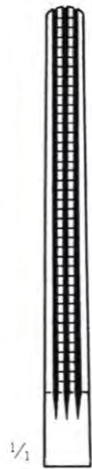

SS-08-368
25.5 cm / 10"
Fig. 1



SS-08-369
25 cm / 9¾"
Fig. 2



SS-08-370
24.5 cm / 9¾"
Fig. 3



SAPTESTAR
Manufacturer & Exporter Of Surgical, Dental & Veterinary Instruments

Hysterectomy Forceps
Pinzas para histerectomía
Pinces a hysterectomie



Wertheim



SS-08-371
22.5 cm / 8 3/4"



Slightly curved
curva ligera
courbe legere



SS-08-372
22.5 cm / 8 3/4"



More curved
curve fuerte
courbe forte



Mikulicz, Baby



SS-08-373
14.5 cm / 5 3/4"



Mikulicz



SS-08-374
18.5 cm / 7 1/4"



Mikulicz



SS-08-375
20 cm / 8"



Hysterectomy Forceps
Pinzas para histerectomía
Pinces a hysterectomie



SS-08-376
23 cm / 9"

Moynihan



SS-08-377
23.5 cm / 9¼"

Moynihan



SS-08-378
26 cm / 10¼"

Wertheim

Hysterectomy Forceps
 Pinzas para histerectomía
 Pincas a hysterectomie



Towel Clamps
Pinzas de campo
Pinces a champs



Schädel
SS-08-383
9 cm / 3½"
sharp
aguda
aigue



SS-08-384
5.5 cm / 2¼"

SS-08-385
8.5 cm / 3¼"

Jones
sharp
aguda
aigue



Jones-Martin
SS-08-386
8.5 cm / 3¼"
sharp
aguda
aigue

With tube holder
con porta-tubo
avec clamp porte-tube



SS-08-387
11.5 cm / 4½"

SS-08-388
13 cm / 5"

Backhaus
Delicate model
modelo delicado
modele gracile



With tube holder
con porta-tubo
avec clamp porte-tube

Backhaus
SS-08-389
11.5 cm / 4½"

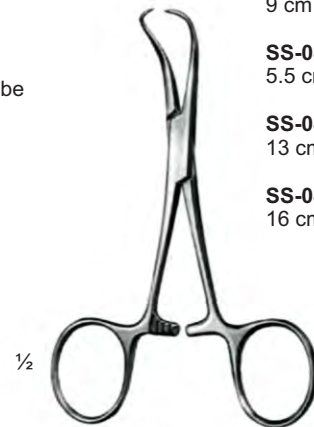

SS-08-390
9 cm / 3½"

SS-08-391
5.5 cm / 2¼"

SS-08-392
13 cm / 5"

SS-08-393
16 cm / 6¼"

Backhaus

Towel Clamps
 Pinzas de campo
 Pinces a champs

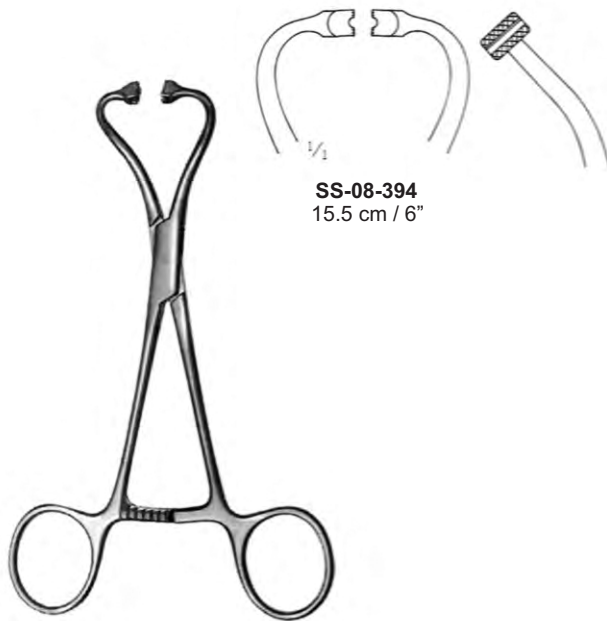

SS-08-394
 15.5 cm / 6"

½ **Peers-Bertram modif.**
 Wide jaw for tube fixation
 boca ancha para fijacion de tubos
 more large pour fixation de tube



½ **Röder**
SS-08-395
 13.5 cm / 5¼"

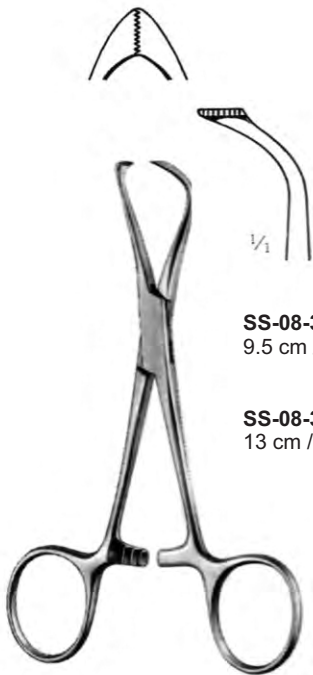

SS-08-396
 9.5 cm / 3¾"

SS-08-397
 13 cm / 5"

½ **Bernhard**
SS-08-398
 16.5 cm / 6½"

Fine serrated wide jaw
 boca ancha, delicadamente dentada
 mors large avec dents fins



Bernhard
SS-08-398
 16.5 cm / 6½"

Towel Clamps
Pinzas de campo
Pinces a champs

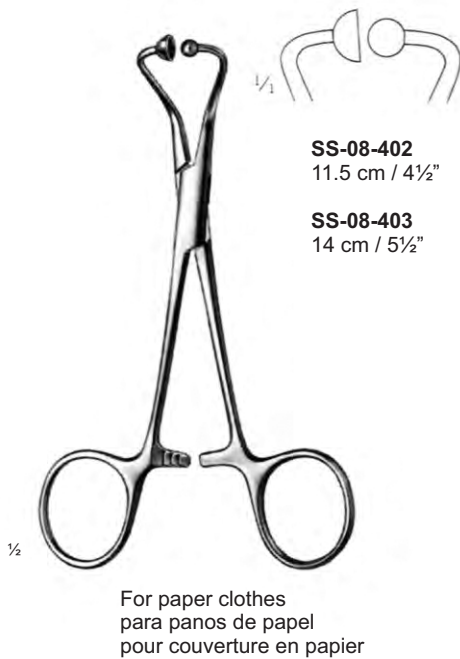
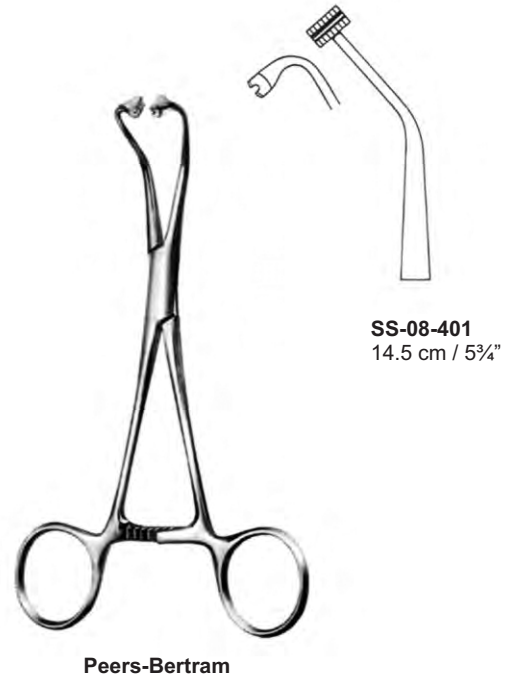

Tubing Clamps
Pinzas para tubos
Pinces presse-tubes

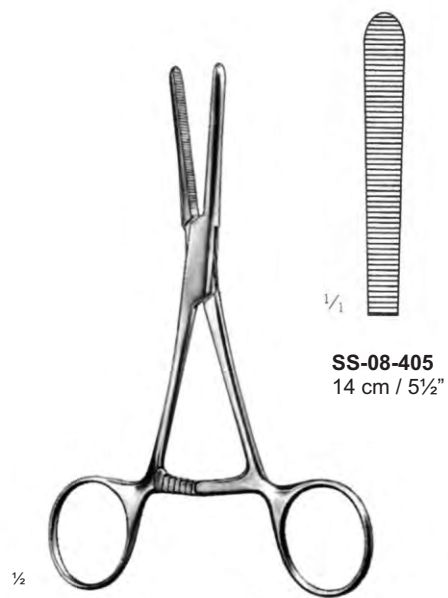

Extra long ratchet
cremallera extra larga
cremaillere extremement longue

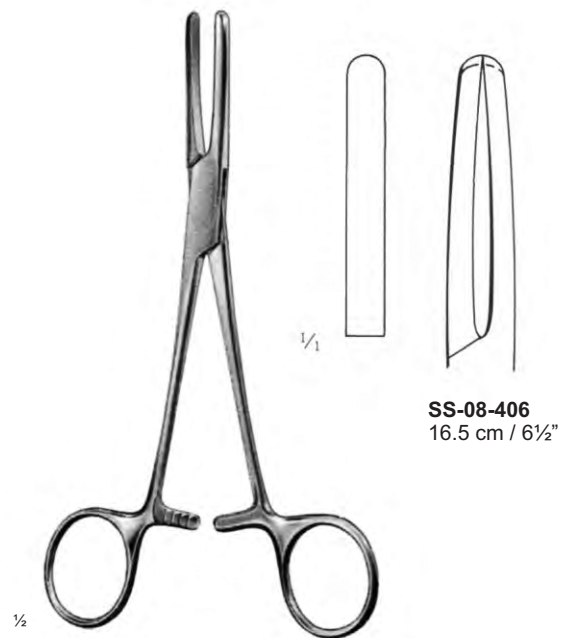

SS-08-406
16.5 cm / 6 1/2"

Tubing Clamps
Pinzas para tubos
Pinces presse-tubes



1/2



1/4

SS-08-407
15.5 cm / 6"



SS-08-408
19 cm / 7 1/2"



SS-08-409
20.5 cm / 8"



1/2



1/4

SS-08-410
15.5 cm / 6"



SS-08-411
19 cm / 7 1/2"



SS-08-412
20.5 cm / 8"

With Safety guard
con estribo de proteccion
avec protection



SAPTESTAR
Manufacturer & Exporter Of Surgical, Dental & Veterinary Instruments

Dressing Forceps
Pinzas para tapones
Pinces a tampons

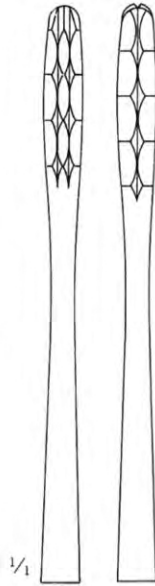

SS-08-413
22.5 cm / 8¾"

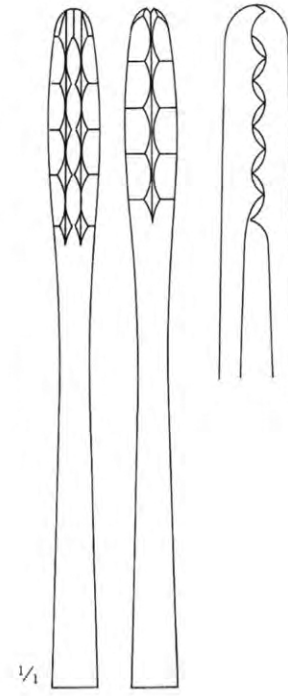

SS-08-414
26.5 cm / 10½"



Ulrich



SS-08-415
22.5 cm / 8¾"

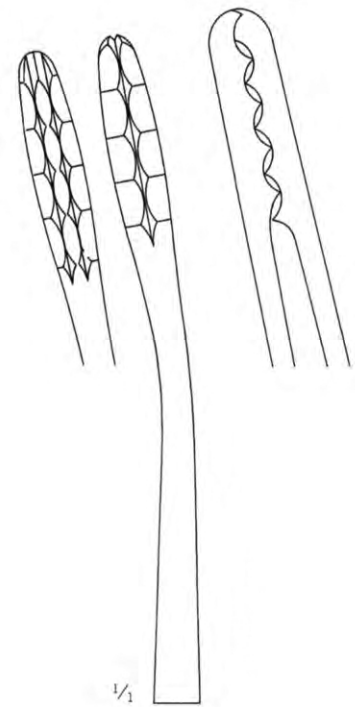

SS-08-416
26.5 cm / 10½"

Dressing Forceps
 Pinzas para tapones
 Pincas a tampons



1/2

Lister



1/4

SS-08-417
 13 cm / 5"



SS-08-418
 16 cm / 6 1/4"



SS-08-419
 18 cm / 7"



1/2

Martin



1/4

SS-08-420
 17.5 cm / 7"



SS-08-421
 17 cm / 6 3/4"

Dressing Forceps
Pinzas para tapones
Pincas a tampons



Gross-Maier

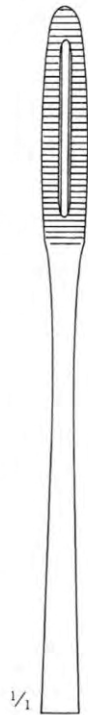

SS-08-422
20.5 cm / 8"

SS-08-424
22 cm / 8 3/4"

SS-08-426
26.5 cm / 10 1/2"



SS-08-423
20 cm / 8"

SS-08-425
21.5 cm / 8 1/2"

SS-08-427
25 cm / 10 1/4"

Dressing Forceps
 Pinzas para tapones
 Pincas a tampons



Sponge Forceps
 Pinzas para tapones
 Pincas a eponges



Foerster



SS-08-431
 25 cm / 9¾"
 Smooth jaw
 boca lisa
 mors lisse

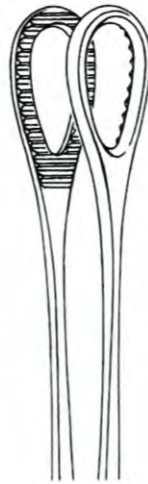

SS-08-432
 18 cm / 7"

SS-08-433
 20.5 cm / 8"

SS-08-434
 25 cm / 9¾"

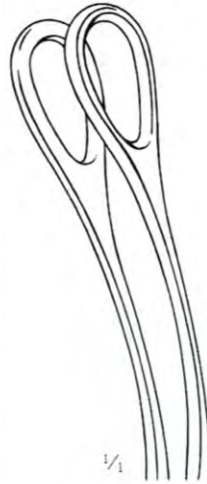

SS-08-435
 24.5 cm / 9¾"
 Smooth jaw
 boca lisa
 mors lisse

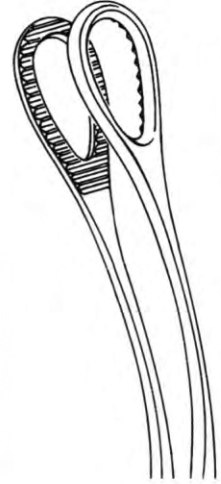

SS-08-436
 17.5 cm / 7"

SS-08-437
 20 cm / 8"

SS-08-438
 24.5 cm / 9¾"

Sponge Forceps
 Pinzas para tapones
 Pincas pour eponges

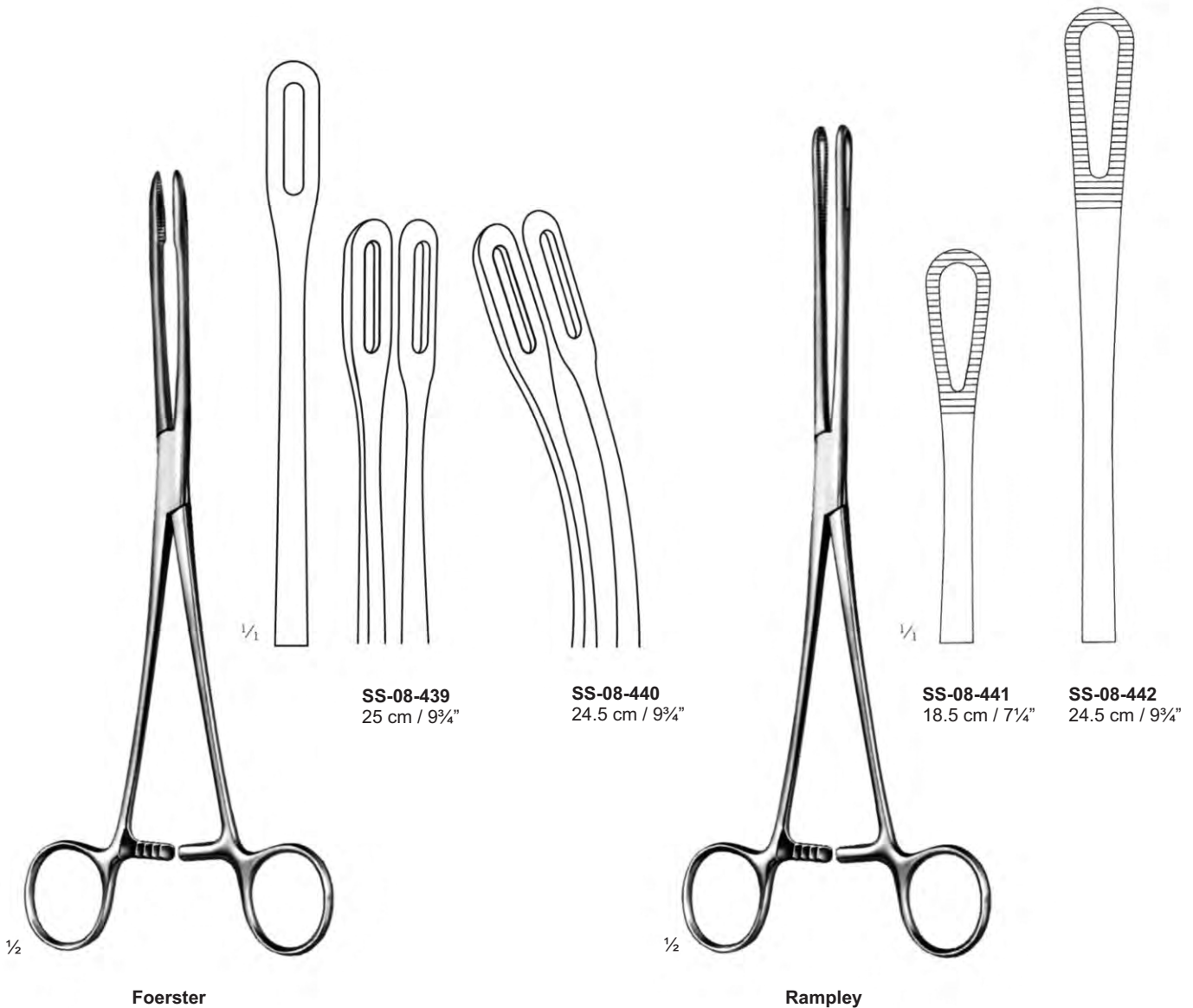

Utrine Dressing Forceps
Pinzas para tapones
Pinces pour eponges



Bozemann
SS-08-443
26 cm / 10¼"

½

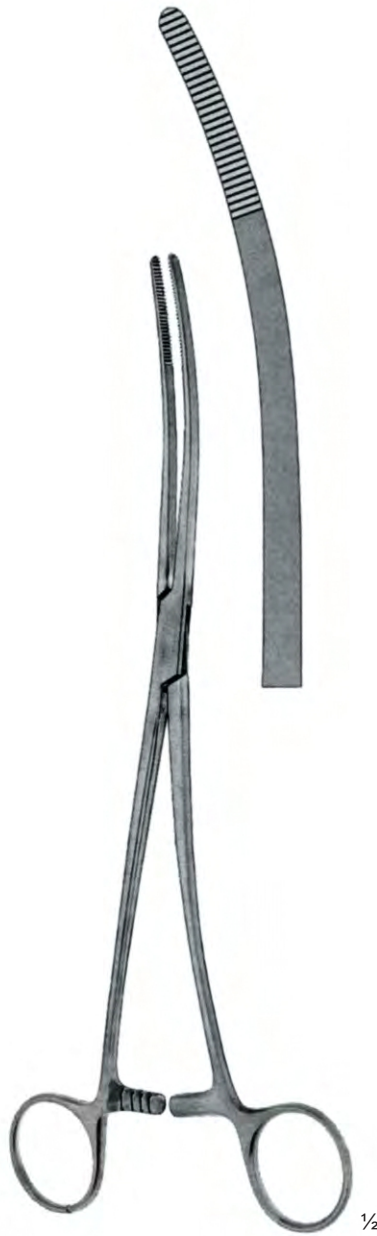

Bozemann
SS-08-444
26 cm / 10¼"

½



Fletcher (Javerts)
SS-08-445
24 cm / 9½"

½