

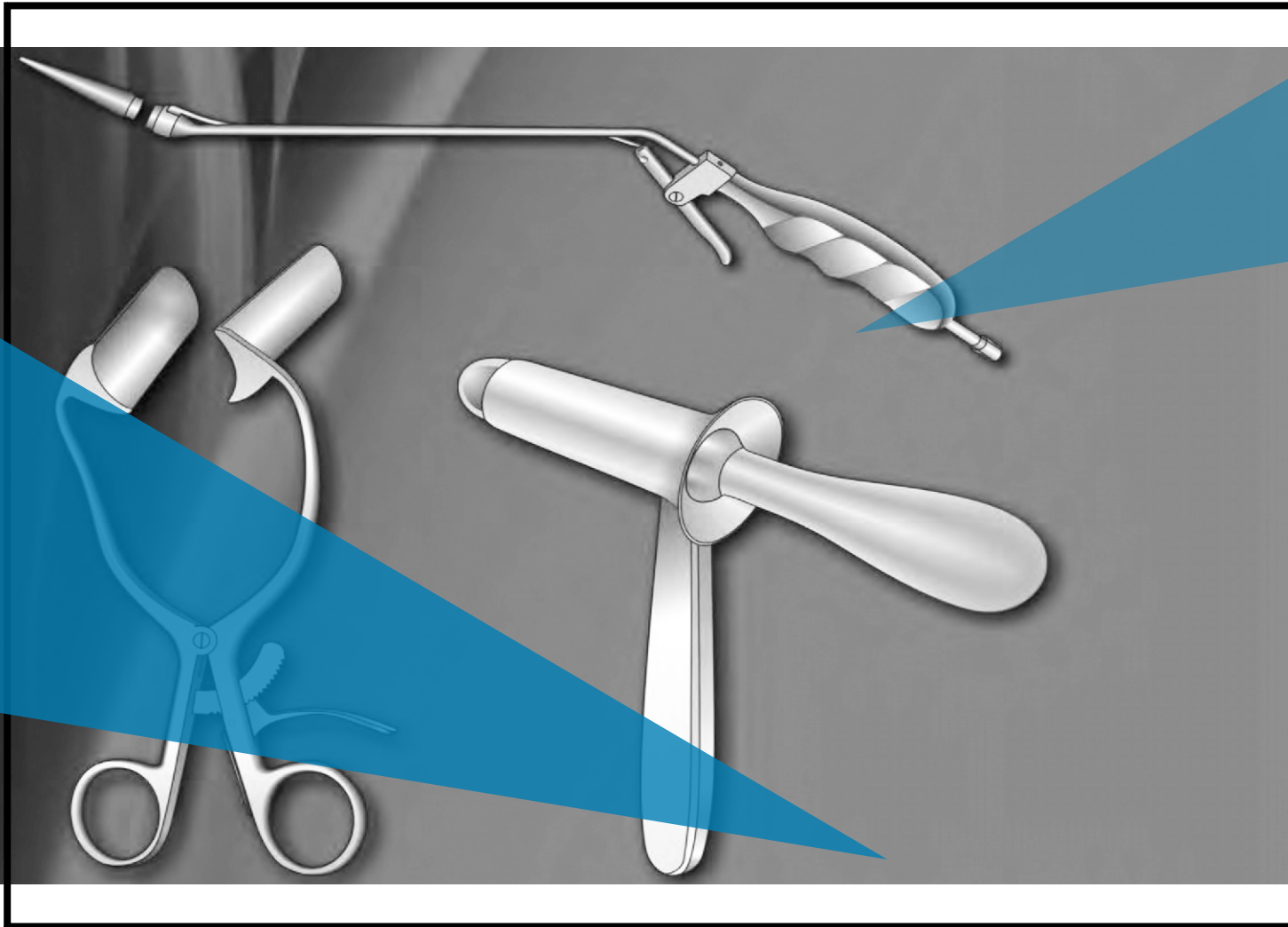

**SAPTESTAR**



**Manufacturers & Exporters Of Quality Surgical Instruments  
Rectal Instruments Catalogue**

**Group 18**

# Rectal Instruments 18

-  +92-340-4040061
-  [exportsaptestar@gmail.com](mailto:exportsaptestar@gmail.com)
-  [info@saptestar.com](mailto:info@saptestar.com)
-  [www.saptestar.com](http://www.saptestar.com)
-  Defence Road, Near Hotel Javson, 51310-Sialkot Pakistan

## *Company Profile*



### ABOUT US

Quality begins at **SapteStar** Instruments Company where master craftsmen forge and manufacture each instrument to its exact specifications and measurements. Instruments must undergo a series of quality control inspections in order to be worthy of **SapteStar** name and warranty. We offer a wide selection of medical instruments including Surgical and Dental instruments.

We have acquired a unique and unmatched understanding of manufacturing through a large experience, working since 1908. Years of experience & state of the art manufacturing facilities helped us to keep our prices low. Our Surgical & Dental instruments are created by expert craftsmen, providing unfaltering quality you can rely on.

We have launched a fully interactive website where you can get online and track your orders 24 hours a day, 7 days in a week, and 365 days a year. Ask for our free e-catalogue on CD-Rom to save time and enjoy hassle free ordering.

We provide our customers with most reliable customer service as your satisfaction is our top priority. Our customers always enjoy our wonderful customer service and quality tools at the best price.

Lastly we invite you to have a work experience with SapteStar Instruments Company and we will prove ourselves as one of the most valuable source you have.

You can find us at

**SapteStar**  
CEO



# *Company Profile*



## History

**SAPTESTAR INSTRUMENTS** was founded in 1995. Our Great Grandfather **Mian Muhammad Fazal Elahi** was the founder of M/s M.F. Elahi & Company (E.P.) Pvt. Ltd, established in 1908. SapteStar is a sister concern of M.F. Elahi & Co. It is our pride to be a member of M.F. Elahi Family.

SapteStar Instruments Company is located in the heart of beautiful city, Sialkot, Pakistan. We are manufacturers and exporters of quality Surgical, Dental instruments and Scissors of all sorts in various categories. We are closely attached with highly skilled surgeons and other technicians of the surgical industry to make the new instruments development possible.

SapteStar is in a continues process of development and testing of new instruments for their precision and perfect functioning. We are also working at imported forging supply by foreign customers.

## Certificates

Instruments Company has achieved the certificates for ISO-9001, ISO-13485, cGMP (FDA) and CE Marking.

## Quality Control

All material use in the manufacturing of our instruments are tested from relevant laboratories. Our continuous quality control is our best warranty so that you built confidence in our products.

## Deliveries

Deliveries are quick and in-time.

## Mode Of Payment

Terms of Payment is ADVANCE or LETTER OF CREDIT (Irrevocable)







# Rectal 18

# 18 intestine

Chaput	01	Pratt	23
Baby-Allis	01	Mathieu	23
Ochsner-Allis	01	Sims	24
Baby-Allis	01	Sims	24
Allis	01	Brinkerhoff	24
Allis	02	Kelly	25
Boys-Allis	02	Hirschmann	25
Adair- Allis	02	Ives-Fansler	25
Judd- Allis	02	Roschke	25
Judd0- Allis	02	Barr	26
Allis	02	Smith-Buie	26
Thoms- Allis	03	Alan-Park	26
Allis	03	Mc Givney	27
Allis	03	Rudd	27
Babcock	03	Haemorrhoidal Suction Ligatora	28
Collin	04	Yeoman	29
Duval-Collin	04	ST.Mark	30
Lockwood	04	Park	30
Duval	04	Hil-Ferguson	30
Pennington	05	Sawyer	30
Loveace	05	Smith-Buie	30
Duval	05		
Williams	06		
Duval	06		
Babcock	06		
Babcock	07		
Duval	07		
Allis	08		
Babcock	08		
Collin	08		
Allis	09		
Redo	09		
Bainbridge	09		
Abay-Kocher	10		
Baby-Doyen	10		
Doyen	11		
Kocher	11		
Doyen	11		
Doyen	12		
Kocher	12		
Doyen	12		
Kocher	13		
Kocher	14		
Mayo-Robson	15		
Scudder	16		
Thoriakson	17		
Thoriakson	18		
Brunner	19		
Hayes	19		
Fehland	20		
Resano	20		
De Martel-Wolfson	21		
Kleinschmidt	21		
Benson	22		
Baby-Payr	22		
Payr	22		
Czerny	23		
Sims	23		

Intestinal & Tissue Grasping Forceps  
Pinzas intestinales y para tejidos  
Pincas a prehension de l'intestin



**Chaput**  
**SS-18-101**  
12.5 cm / 5"  
2x3 teeth  
2x3 dientes  
2x3 dents



**Baby-Allis**  
**SS-18-102**  
12 cm / 4 ¾"  
4x5 teeth  
4x5 dientes  
4x5 dents



**Ochsner-Allis**  
**SS-18-103**  
13.5 cm / 5 ¼"  
4x5 teeth  
4x5 dientes  
4x5 dents



**Baby-Allis**  
**SS-18-104**  
14 cm / 5 ½"  
4x5 teeth  
4x5 dientes  
4x5 dents



**Allis**  
**SS-18-105**  
15.5 cm / 6"  
4x5 teeth  
4x5 dientes  
4x5 dents

Intestinal & Tissue Grasping Forceps  
 Pinzas intestinales y para tejidos  
 Pincas a prehension de l'intestin



**Allis**  
**SS-18-106**  
 15.5 cm / 6"  
 5x6 teeth  
 5x6 dientes  
 5x6 dents

1/2



**Boys-Allis**  
**SS-18-107**  
 15.5 cm / 6"  
 5x6 teeth  
 5x6 dientes  
 5x6 dents

1/2



**Adair-Allis**  
**SS-18-108**  
 16 cm / 6 1/4"  
 10x11 teeth  
 10x11 dientes  
 10x11 dents

1/2



**Judd-Allis**  
**SS-18-109**  
 15.5 cm / 6"  
 3x4 teeth  
 3x4 dientes  
 3x4 dents

1/2



**Judd-Allis**  
**SS-18-110**  
 19 cm / 7 1/2"  
 3x4 teeth  
 3x4 dientes  
 3x4 dents

1/2



**Allis**  
**SS-18-11**  
 19 cm / 7 1/2"  
 5x6 teeth  
 5x6 dientes  
 5x6 dents

1/2

Intestinal & Tissue Grasping Forceps  
Pinzas intestinales y para tejidos  
Pinces a prehension de l'intestin



8x9 teeth  
8x9 dientes  
8x9 dents

**Thoms-Allis**  
**SS-18-112**  
20.5 cm / 8"  $\frac{1}{2}$



5x6 teeth  
5x6 dientes  
5x6 dents

**Allis**  
**SS-18-113**  
22.5 cm / 9"  $\frac{1}{2}$



5x6 teeth  
5x6 dientes  
5x6 dents

**Allis**  
**SS-18-114**  
25 cm / 10"  $\frac{1}{2}$



**Babcock**  $\frac{1}{2}$



**SS-18-115**  
14.5 cm / 5  $\frac{3}{4}$ "



**SS-18-116**  
16 cm / 6  $\frac{1}{4}$ "



**SS-18-117**  
17 cm / 6  $\frac{3}{4}$ "



**SS-18-118**  
20.5 cm / 8"



**SS-18-119**  
23.5 cm / 9  $\frac{1}{4}$ "



Intestinal & Tissue Grasping Forceps  
 Pinzas intestinales y para tejidos  
 Pincas a prehension de l'intestin



**Collin**  
**SS-18-120**  
 13.5 cm / 5 1/4"



**SS-18-121**  
 20.5 cm / 8"

**Duval-Collin**



**SS-18-122**  
 20.5 cm / 8"



**Lockwood**  
**SS-18-123**  
 20 cm / 8"



**SS-18-124**  
 23 cm / 9"

**Duval**



**SS-18-125**  
 23 cm / 9"



Intestinal & Tissue Grasping Forceps  
Pinzas intestinales y para tejidos  
Pincas a prehension de l'intestin



**Pennington**  
**SS-18-126**  
15 cm / 6"



**Pennington**  
**SS-18-127**  
20 cm / 8"



**Lovelace**  
**SS-18-128**  
19 cm / 7 1/2"



**SS-18-129**  
20 cm / 8"



**SS-18-130**  
20 cm / 8"

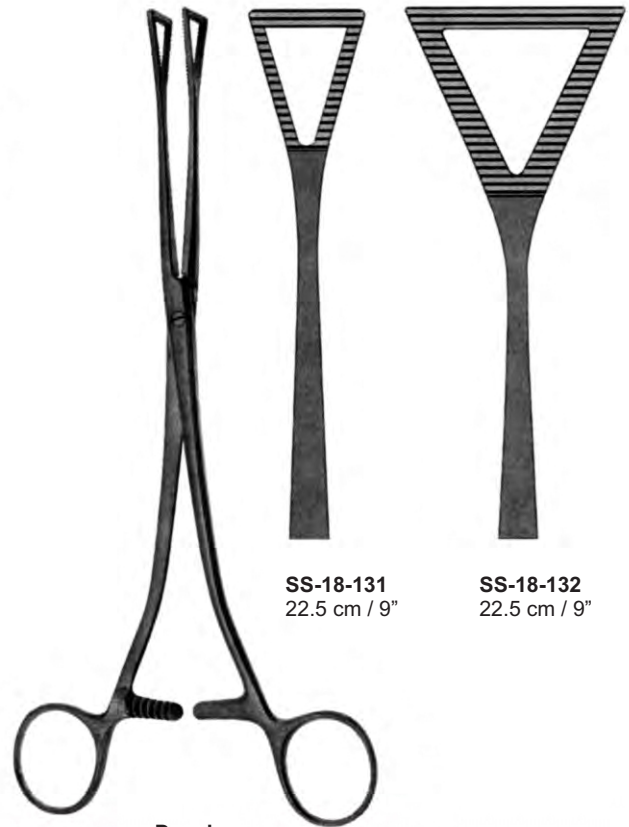

**SS-18-131**  
22.5 cm / 9"

**SS-18-132**  
22.5 cm / 9"



**SAPTESTAR**  
Manufacturer & Exporter Of Surgical, Dental & Veterinary Instruments

Intestinal & Tissue Grasping Forceps  
Pinzas intestinales y para tejidos  
Pinces a prehension de l'intestin



**Williams**  
**SS-18-133**  
16 cm / 6 1/4"



**Duval**  
**SS-18-134**  
20.5 cm / 8"  
with tungsten carbide inserts  
con bocas de carburo tungsteno  
avec mors en tungstene



**SS-18-135**  
16 cm / 6 1/4"

**Babcock**  
with tungsten carbide inserts  
con bocas de carburo tungsteno  
avec mors en tungstene



**SS-18-136**  
17.5 cm / 7"



**SS-18-137**  
20.5 cm / 8"

Intestinal & Tissue Grasping Forceps  
 Pinzas intestinales y para tejidos  
 Pincas a prehension de l'intestin



**Babcock**

1/1

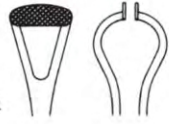

**SS-18-138**  
 16.5 cm / 6 1/2"

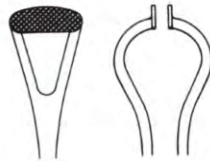

**SS-18-139**  
 21 cm / 8 1/4"



**Duval**

1/1



**SS-18-140**  
 20.5 cm / 8"

Intestinal & Tissue Grasping Forceps  
 Pinzas intestinales y para tejidos  
 Pincas a prehension de l'intestin

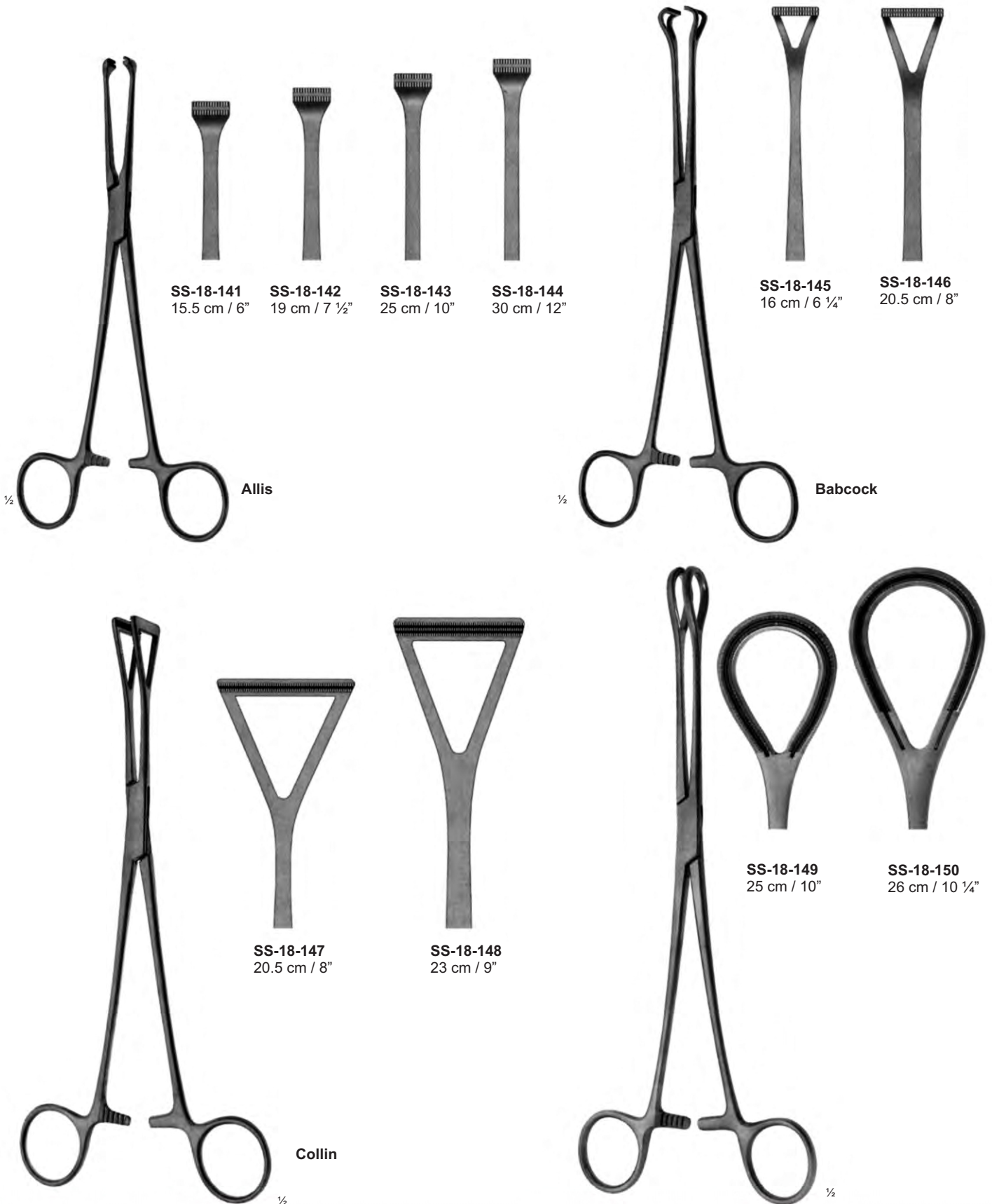

**SS-18-141**  
 15.5 cm / 6"

**SS-18-142**  
 19 cm / 7 1/2"

**SS-18-143**  
 25 cm / 10"

**SS-18-144**  
 30 cm / 12"

**SS-18-145**  
 16 cm / 6 1/4"

**SS-18-146**  
 20.5 cm / 8"

Allis

Babcock

**SS-18-147**  
 20.5 cm / 8"

**SS-18-148**  
 23 cm / 9"

**SS-18-149**  
 25 cm / 10"

**SS-18-150**  
 26 cm / 10 1/4"

Collin

Intestinal Clamps Forceps  
Pinzas-clamps intestinales  
Pinces-clamps intestinales



**Allen**  
1x2 teeth  
1x2 dientes  
1x2 dents



**SS-18-151**  
15 cm / 6"



**SS-18-152**  
20 cm / 8"



**Redo**  
1x2 teeth  
1x2 dientes  
1x2 dents



**SS-18-153**  
20 cm / 8"



**SS-18-154**  
26 cm / 10 1/4"



**Rainbridge**



**SS-18-155**  
15 cm / 6"



**SS-18-156**  
18.5 cm / 7 1/4"



**SS-18-157**  
15 cm / 6"



**SS-18-158**  
18.56 cm / 7 1/4"

Intestinal Clamps Forceps  
 Pinzas-clamps intestinales  
 Pincas-clamps intestinales

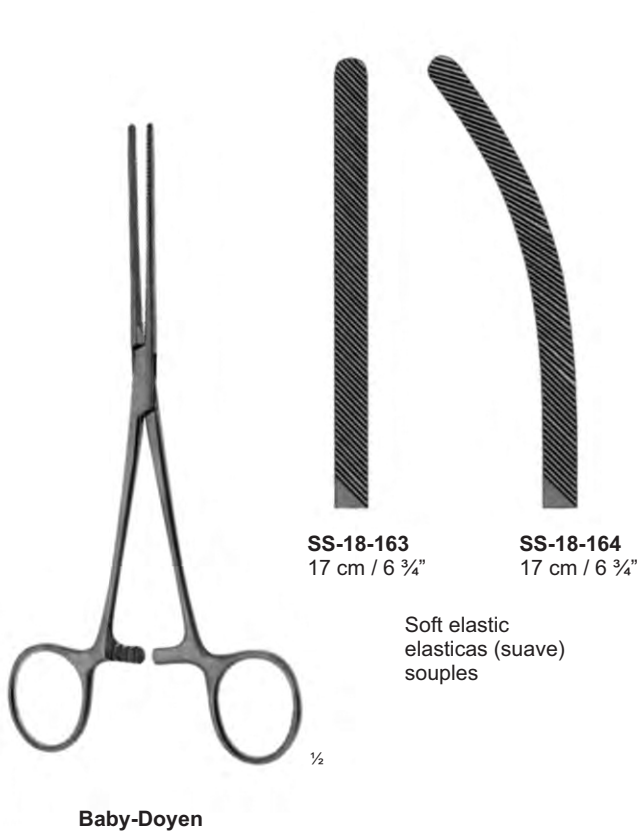
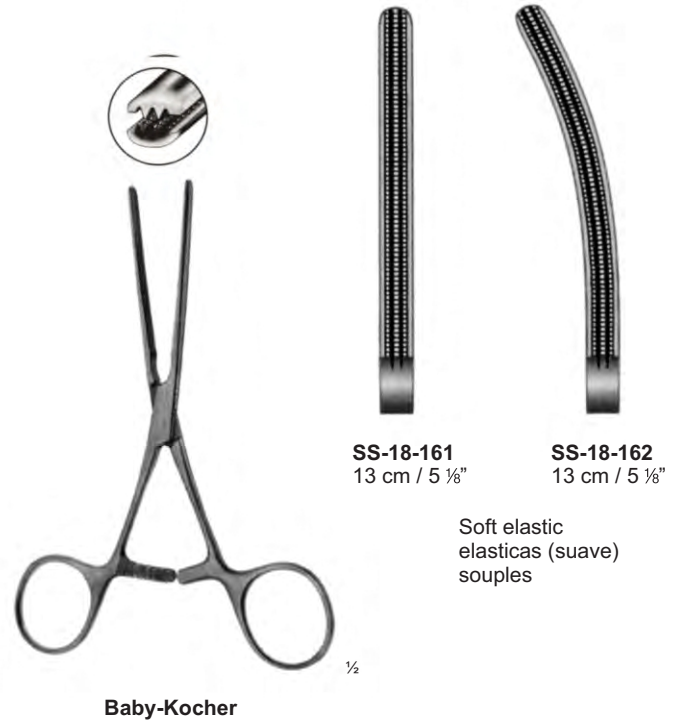
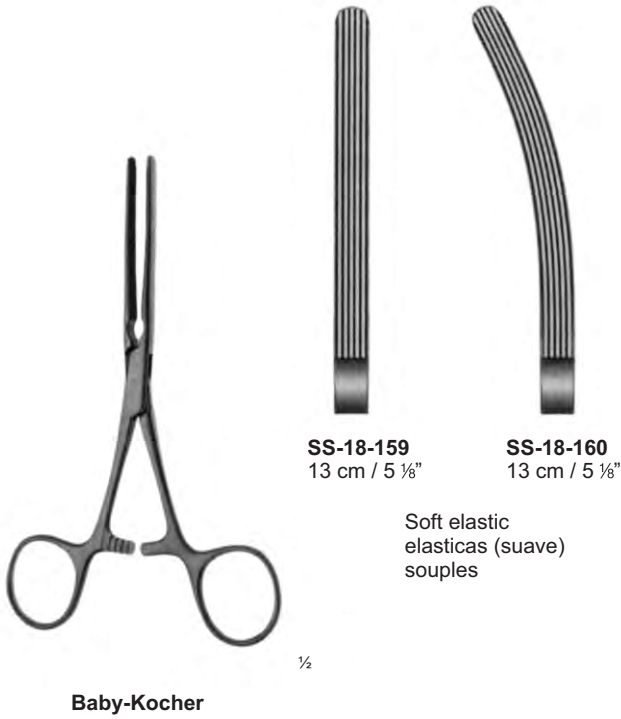



Intestinal Clamps Forceps  
Pinzas-clamps intestinales  
Pinces-clamps intestinales

With non-traumatic serration  
con bocas atraumaticas  
avec mors atrauma



**SS-18-167**  
21 cm / 8 ¼"

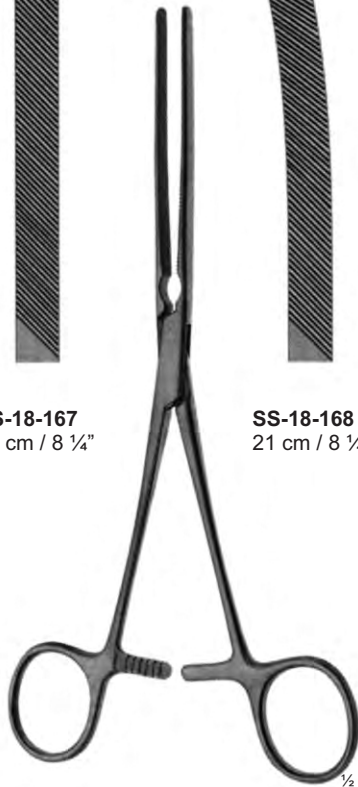

**Doyen**  
soft elastic  
elásticas (suave)  
souples



**SS-18-168**  
21 cm / 8 ¼"

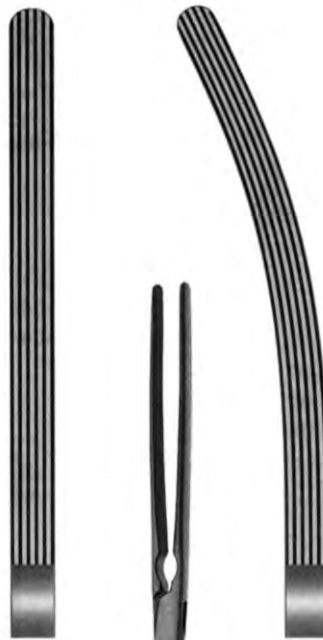

**SS-18-169**  
21 cm / 8 ¼"

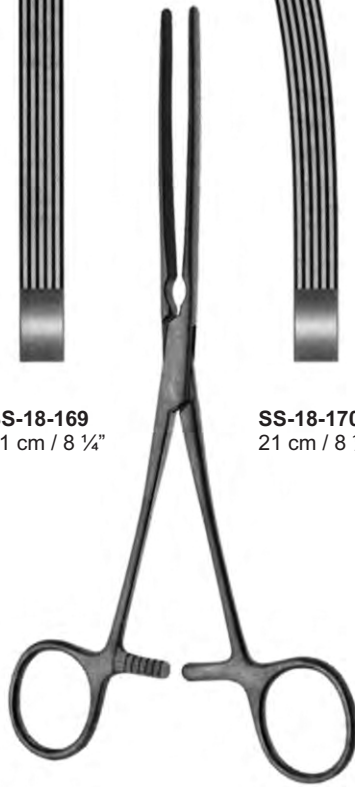

**Kocher**  
soft elastic  
elásticas (suave)  
souples



**SS-18-170**  
21 cm / 8 ¼"



**SS-18-171**  
21 cm / 8 ¼"



**Doyen**  
soft elastic  
elásticas (suave)  
souples



**SS-18-172**  
21 cm / 8 ¼"



Intestinal Clamps Forceps  
 Pinzas-clamps intestinales  
 Pinces-clamps intestinales

With non-traumatic serration  
 con bocas atraumaticas  
 avec mors atrauma  
 con morsi atraumatici



**SS-18-173**  
 23 cm / 9"



**SS-18-174**  
 23 cm / 9"



**SS-18-175**  
 23 cm / 9"



**SS-18-176**  
 23 cm / 9"



**SS-18-177**  
 23 cm / 9"



**SS-18-178**  
 23 cm / 9"



**Doyen**  
 soft elastic  
 elasticas (sauve)  
 souples



**Kocher**  
 soft elastic  
 elasticas (sauve)  
 souples

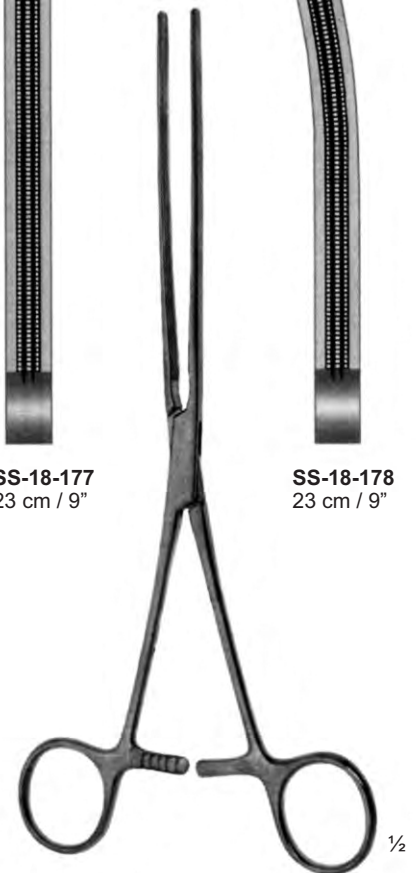

**Doyen**  
 soft elastic  
 elasticas (sauve)  
 souples

Intestinal Clamps Forceps  
Pinzas-clamps intestinales  
Pinces-clamps intestinales

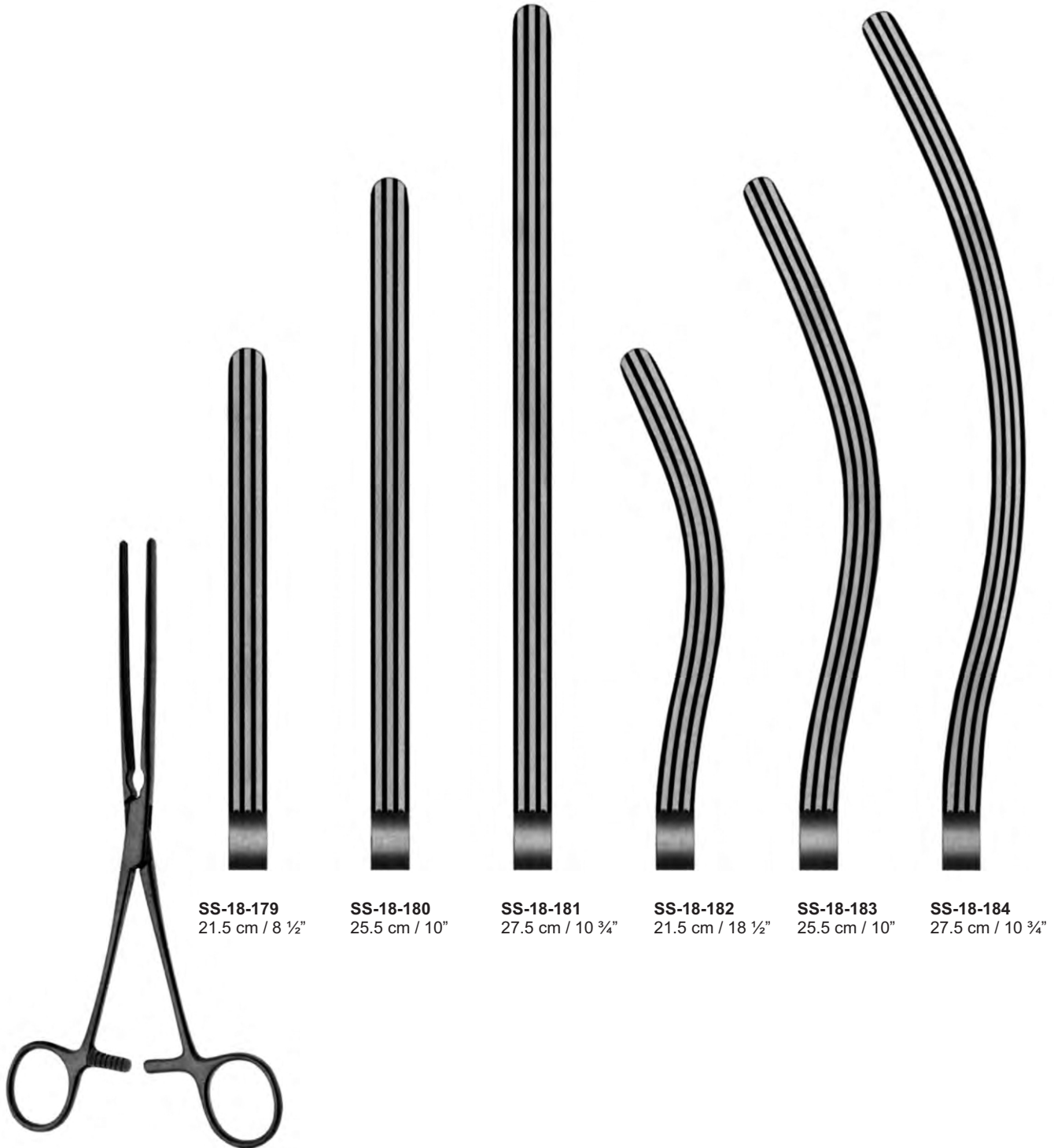

**SS-18-179**  
21.5 cm / 8 ½"

**SS-18-180**  
25.5 cm / 10"

**SS-18-181**  
27.5 cm / 10 ¾"

**SS-18-182**  
21.5 cm / 18 ½"

**SS-18-183**  
25.5 cm / 10"

**SS-18-184**  
27.5 cm / 10 ¾"

**Kocher**  
soft elastic  
elásticas (sauve)  
souples

Intestinal Clamps Forceps  
Pinzas-clamps intestinales  
Pinces-clamps intestinales



Intestinal Clamps Forceps  
Pinzas-clamps intestinales  
Pinces-clamps intestinales

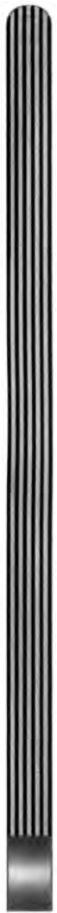

**SS-18-191**  
25.5 cm / 10"



**SS-18-192**  
25.5 cm / 10"

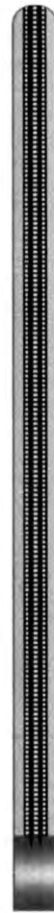

**SS-18-193**  
25.5 cm / 10"



**SS-18-194**  
25.5 cm / 10"

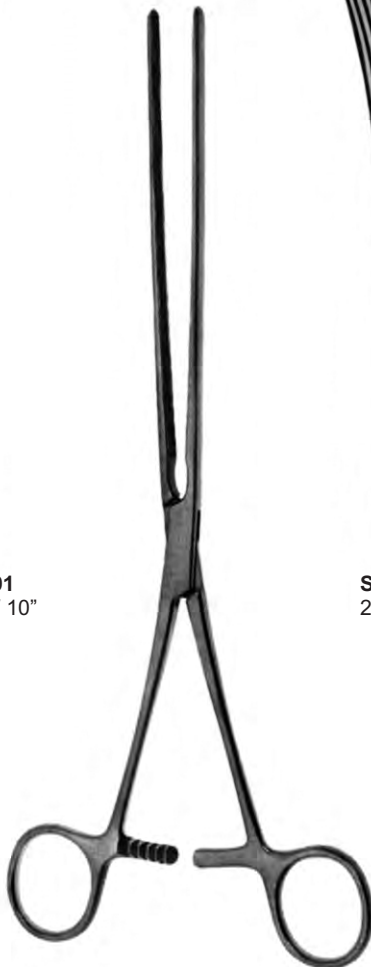

**Mayo-Robson**  
hard elastic  
elásticas (duro)  
fermes

½



**Mayo-Robson**  
hard elastic, with non-traumatic serration  
elásticas (duro), con bocas atraumáticas  
fermes, avec mors atrauma

½



**SAPTESTAR**  
Manufacturer & Exporter Of Surgical, Dental & Veterinary Instruments

Stomach Clamps Forceps  
Pinzas-clamps estomacales  
Pinces-clamps stomacales



**SS-18-195**  
33 cm / 13"



**Scudder**

1/2



**SS-18-196**  
33 cm / 13"

Upper Occlusive Clamps  
Pinzas-clamps oclusiva superior  
Pinces-clamps a occlusion



**Thorlakson**  
**SS-18-197**  
29 cm / 11 ½"  
for use in anterior resection of the rectum  
para el uso da la reseccion anterior del recto  
Utilise pour la reseccion anterieure du rectum



Lower Occlusive Clamps  
Pinzas-clamps oclusiva interior  
Pinces-clamps a occlusion

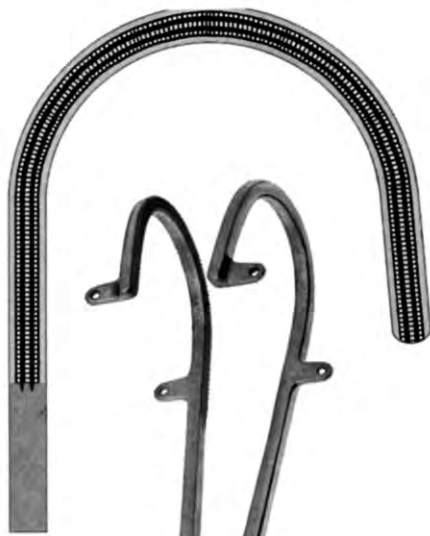

**Thorlakson  
SS-18-198**  
29 cm / 11 1/2"  
For use in anterior resection of the  
rectum on the female patient  
Para el uso de la reseccion anterior  
del recto de la mujer  
utilise pour la reseccion anterieure du  
rectum chez la femme



1/2

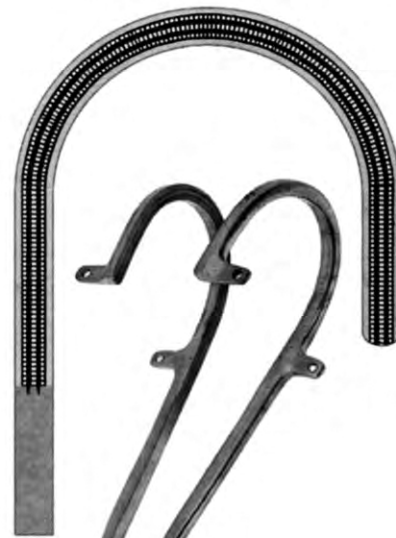

**Thorlakson  
SS-18-199**  
29 cm / 11 1/2"  
For use in anterior resection of the  
rectum on the male patient  
Para el uso de la reseccion anterior  
del recto del hombre  
utilise pour la reseccion anterieure du  
rectum chez l' homme



1/2



Sigmoid Anastomosis Forceps  
 Pinzas para anastomosis de recto  
 Pinces clamps a anastomose du rectum



**Brunner**  
**SS-18-200**  
 26.5 cm / 10 1/2"



**Hayes**



**SS-18-201**  
 30 cm / 12"



**SS-18-202**  
 30.5 cm / 12"

With non-traumatic serration  
 con bocas atraumaticas  
 avec mors atrauma

Sigmoid Anastomosis Forceps  
Pinzas para anastomosis de recto  
Pincas clamps a anastomose du rectum

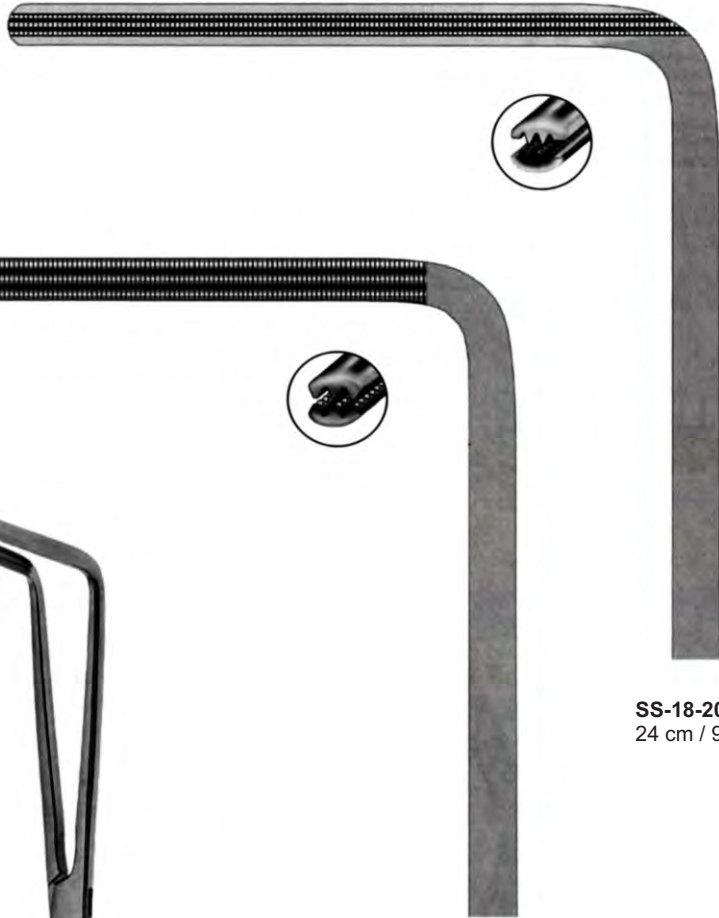
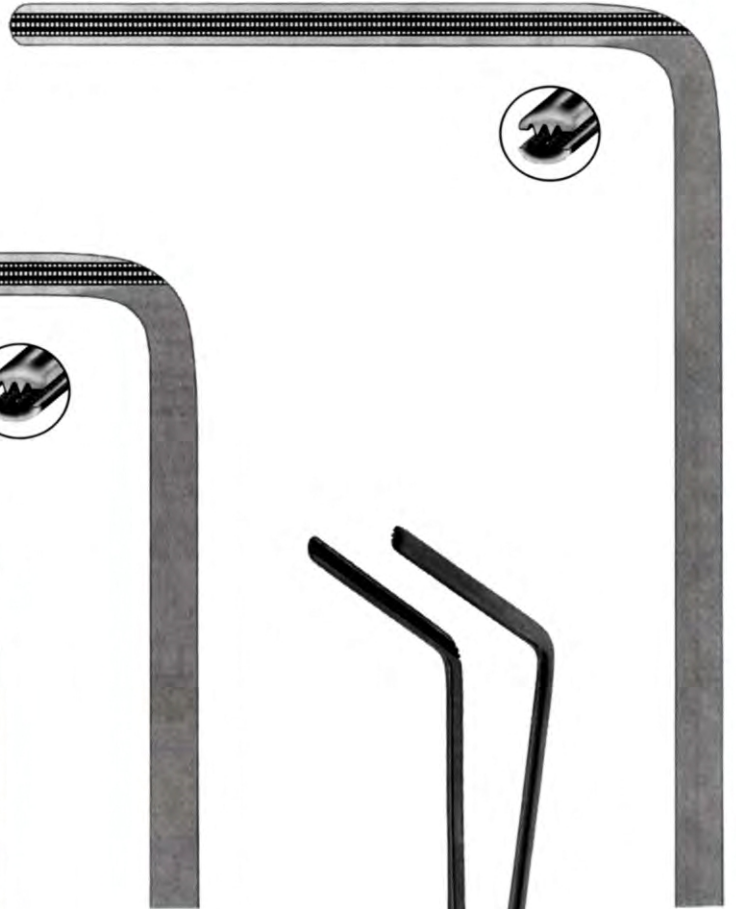

Clamps Closing Forceps  
Pinzas para cerrar los clamps  
Pincettes pour fermer les clamps



**De Martel-Wolfson**  
**SS-18-206**  
24.5 cm / 9 3/4"  
Clamp closing forceps  
Pinzas para cerrar los clamps  
Pince pour fermer les clamps



**Kleinschmidt**  
**SS-18-207**  
12.5 cm / 5"  
Super crusher and appendectomy clamp  
Machacadora para espora y clamp para apendectomia  
Ecraseur et clamp a appendicectomie



**SAPTESTAR**  
Manufacturer & Exporter Of Surgical, Dental & Veterinary Instruments

Intestine & Stomach Clamps  
Pinzas-clamps intestinales y estomacales  
Pinces-clamps pour l'intestinales et l'estomac



**Benson**  
**SS-18-208**  
15.5 cm / 6"  
Pylorus spreader  
Separador para piloro  
Ecarteur du pylore



**Baby-Payr**  
**SS-18-209**  
15.5 cm / 6"  
Intestinal and stomach clamp with pin  
Pinza-clamp intestinales y estomacales con espiga  
Pince-clamp et ecraseurs pour l'intestin et l'estomac avec pointe



**Payr**  
Intestinal and stomach clamps with pin  
Pinzas-clamps intestinales y estomacales con espiga  
Pince-clamps et ecraseurs pour l'intestin et l'estomac avec pointe



**SS-18-210**  
20 cm / 8"



**SS-18-211**  
29 cm / 11 1/2"

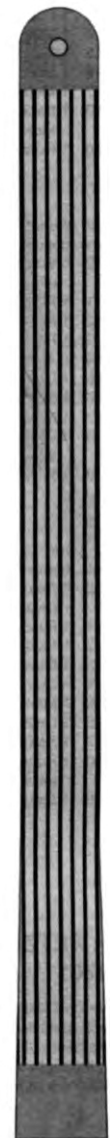

**SS-18-212**  
34 cm / 13 1/2"

Rectal Speculs  
 Especulos para el recto  
 Speculum rectaux



105 x 23-28 mm  
 (AXB)

**Czerny**  
**SS-18-213**  
 22.5 cm / 9"

½



75 x 17 mm  
 (AXB)

**Sims**  
**SS-18-214**  
 15.5 cm / 6"

½



75 x 17 mm  
 (AXB)

**Sims**  
**SS-18-215**  
 15.5 cm / 6"

½



80 x 25 mm  
 (AXB)

**Pratt**  
**SS-18-216**  
 20.5 cm / 8"

½

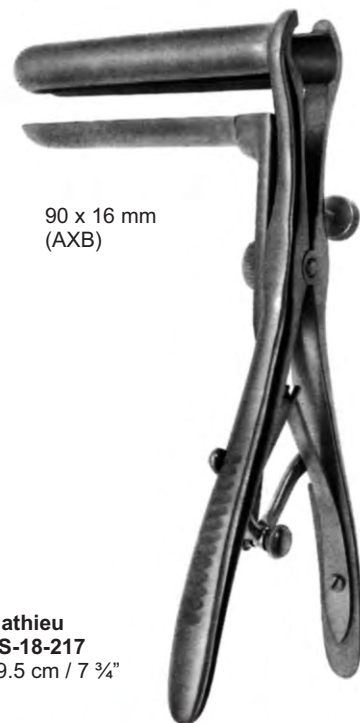

90 x 16 mm  
 (AXB)

**Mathieu**  
**SS-18-217**  
 19.5 cm / 7 ¾"

½

Rectal Speculs  
Especulos para el recto  
Speculum rectaux



- SS-18-219** 80 x 25 mm (AXB)
- SS-18-220** 125 x 25 mm (AXB)
- SS-18-221** 150 x 25 mm (AXB)



Sphincteroscopes, Rectal Retractor  
Esfinteroscopios, Separador para el recto  
Sphincteroscopes, Dilatateurs pour anus et rectum

50 mm



**Kelly**  
**SS-18-224** ø 21 mm x 50 mm  
**SS-18-225** ø 27 mm x 50 mm  
Sphincteroscopes  
Esfinteroscopios  
Sphincteroscopes

65 mm



**Hirschmann**  
**SS-18-226** ø 19 mm x 65 mm  
**SS-18-227** ø 22 mm x 65 mm  
Anoscopes  
Anoscopios  
Anuscopes

80 mm



**Ives-Fansler**  
**SS-18-228**  
ø 22 mm x 80 mm  
Anoscope with vulcanite obturator  
Anoscopio con obturador de plástico  
Anuscopes avec opturateur en ebonite

70 mm



**Roschke**  
**SS-18-229**  
ø 15-30 mm x 70 mm  
Rectal retractor  
Separador para el recto  
Dilatateur pour anus





**SAPTESTAR**  
 Manufacturer & Exporter Of Surgical, Dental & Veterinary Instruments

Rectal Retractor  
 Separador para el recto  
 Dilatateurs pour anus et rectum

70 x 22 mm  
 (AXB)



**Barr**  
**SS-18-230**  
 18.5 cm / 7 1/4"

55 x 23 mm  
 (AXB)



**Smith-Buie**  
**SS-18-231**

**SS-18-234**



**SS-18-236**

**Alan-Park**  
**SS-18-232**  
 14.5 cm / 5 3/4"

Rectal retractor with ball snap closure, complete, consisting of:

- SS-18-233** 1 Spreader
- SS-18-234** 1 pair lateral valves 75 x 22 mm (AxB)
- SS-18-235** 1 pair lateral valves 95 x 22 mm (AxB)
- SS-18-236** 1 Central valve 95 x 22 mm (AxB)

Separador para el recto con cierre esferico, completo, compuesto de

- SS-18-233** 1 Separador
- SS-18-234** 1 Par de valvas laterales 75 x 22 mm (AxB)
- SS-18-235** 1 Par de valvas laterales 95 x 22 mm (AxB)
- SS-18-236** 1 Valve central 95 x 22 mm (AxB)

Ecarteur rectal, complet, compose de:

- SS-18-233** 1 Dilataeur
- SS-18-234** 1 Paire de valvas laterales 75 x 22 mm (AxB)
- SS-18-235** 1 Paire de valvas laterales 95 x 22 mm (AxB)
- SS-18-236** 1 Valve centrale 95 x 22 mm (AxB)



**SS-18-235**

Haemorrhoidal Forceps  
Pinza-clamps para hemorroides  
Pinces-clamps pour hemorroides



**SS-18-400**  
Shaft = 17 cm



**Mc Givney**  
**SS-18-237**  
19 cm / 7 1/2"  
Haemorrhoidal Forceps  
Pinza-clamp para hemorroides  
Pinces-clamps pour hemorroides



**SS-18-238**  
Ligature rubber rings, in package of 100 pieces  
Anillos de goma para ligadura, en paquete de 100 piezas  
Bagues de caoutchouc pour ligatures, paquet de 100 pieces



**Rudd**  
**SS-18-239**  
27.5 cm / 10 3/4"  
Haemorrhoidal ligator with loading attachment ø 12 mm (SS-18-240)  
Ligador para hemorroides con cono de carga ø 12 mm (SS-18-240)  
Ligateur hemorroidal avec cone de charge ø 12 mm (SS-18-240)

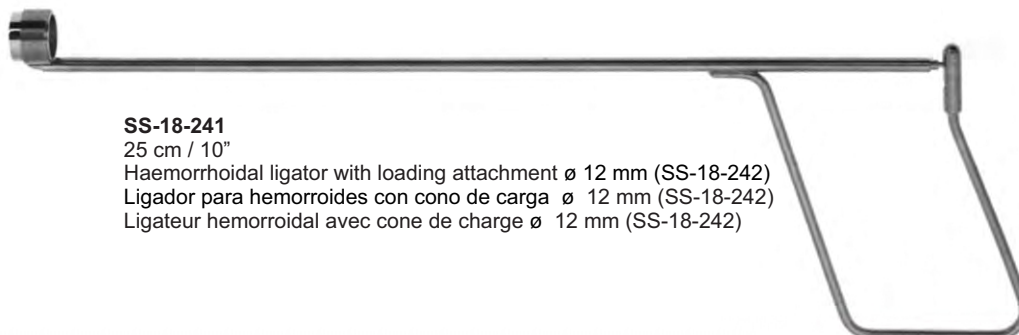

**SS-18-241**  
25 cm / 10"  
Haemorrhoidal ligator with loading attachment ø 12 mm (SS-18-242)  
Ligador para hemorroides con cono de carga ø 12 mm (SS-18-242)  
Ligateur hemorroidal avec cone de charge ø 12 mm (SS-18-242)

Haemorrhoidal Suction Ligator  
Ligadores de aspiracion para hemorroides  
Ligateurs aspirateurs pour hemorroides

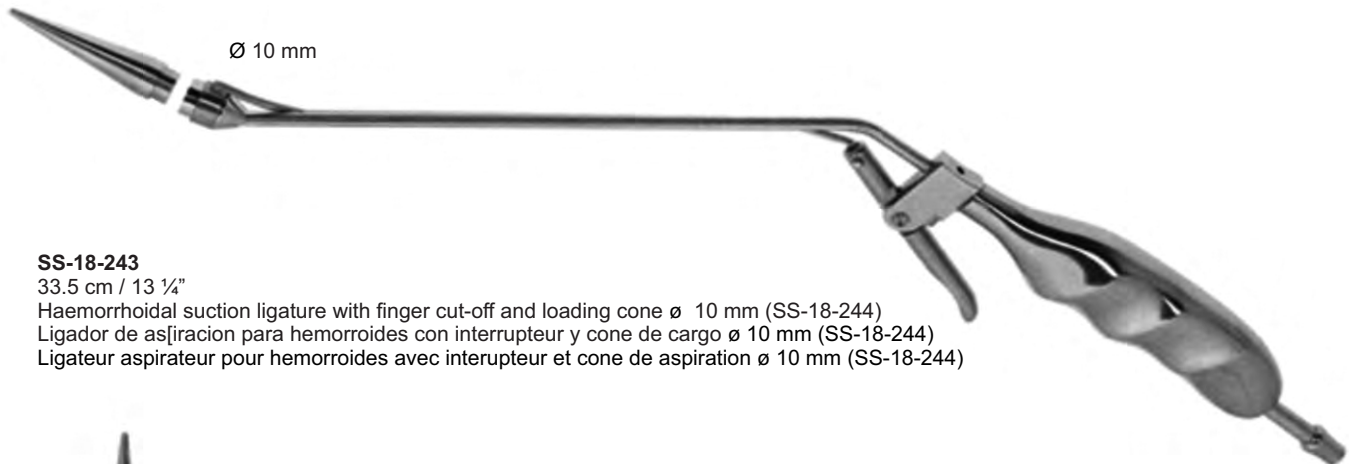

**SS-18-243**

33.5 cm / 13 1/4"

Haemorrhoidal suction ligature with finger cut-off and loading cone ø 10 mm (SS-18-244)

Ligador de aspiracion para hemorroides con interruptor y cone de carga ø 10 mm (SS-18-244)

Ligateur aspirateur pour hemorroides avec interrupteur et cone de aspiration ø 10 mm (SS-18-244)

1/2



**SS-18-245**

36.5 cm / 14 1/2"

Haemorrhoidal suction ligature with finger cut-off and loading cone ø 8 mm (SS-18-246)

Ligador de aspiracion para hemorroides con interruptor y cone de carga ø 8 mm (SS-18-246)

Ligateur aspirateur pour hemorroides avec interrupteur et cone de aspiration ø 8 mm (SS-18-246)

1/2

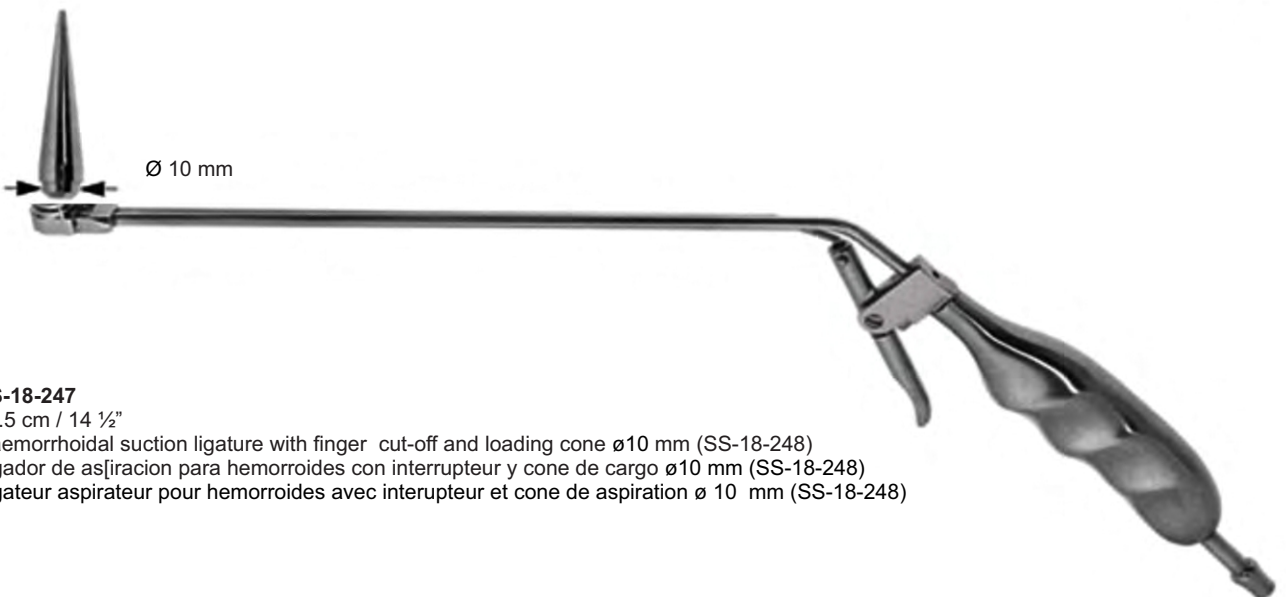

**SS-18-247**

36.5 cm / 14 1/2"

Haemorrhoidal suction ligature with finger cut-off and loading cone ø 10 mm (SS-18-248)

Ligador de aspiracion para hemorroides con interruptor y cone de carga ø 10 mm (SS-18-248)

Ligateur aspirateur pour hemorroides avec interrupteur et cone de aspiration ø 10 mm (SS-18-248)

1/2

Rectal Biopsy Specimen Forceps  
Pinzas sacabocado para biopsia rectal  
Pincas a biopsie rectale

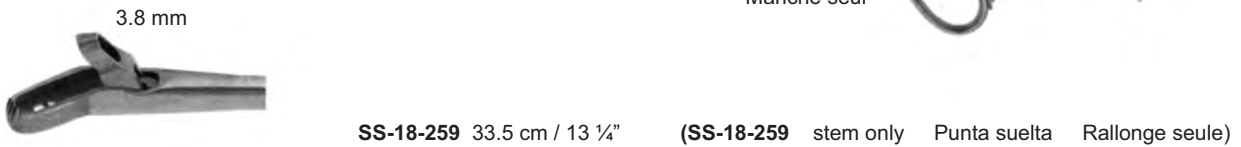
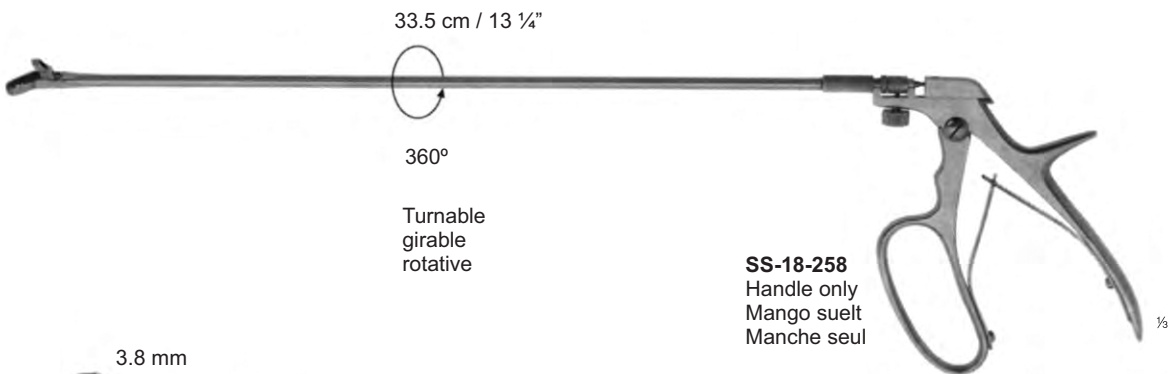
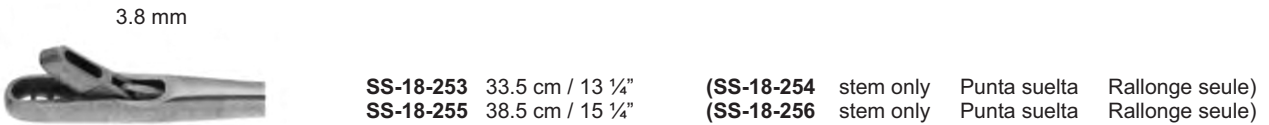
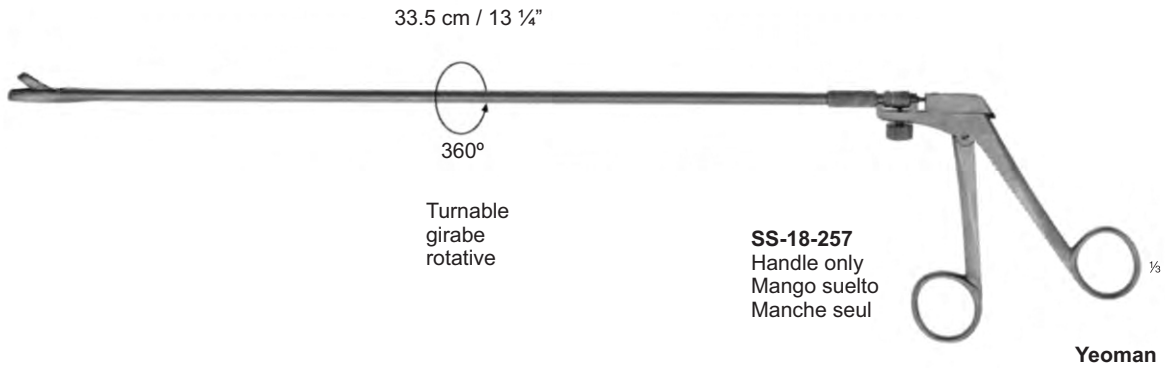
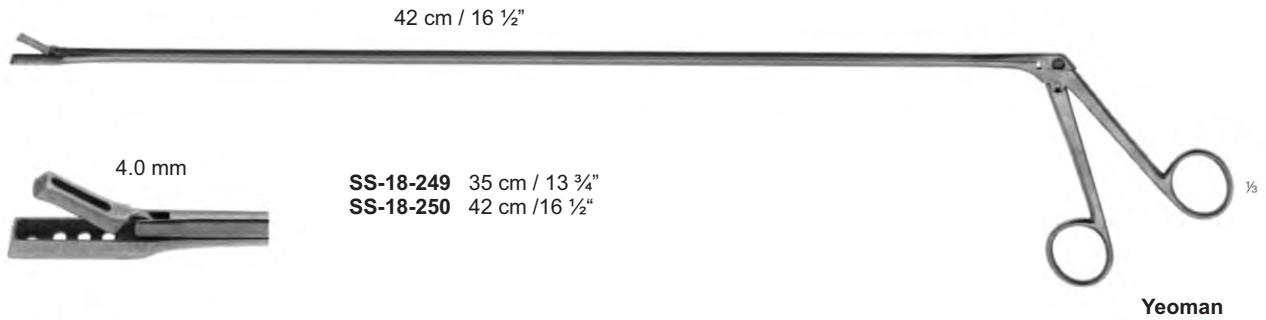



**SAPTESTAR**  
Manufacturer & Exporter Of Surgical, Dental & Veterinary Instruments

Rectal Retractors  
Separadores para el recto  
Dilatateurs pour anus et rectum

12/20 x 70 mm



**Ricord**  
SS-18-270  
16 cm

16/10 x 70 mm

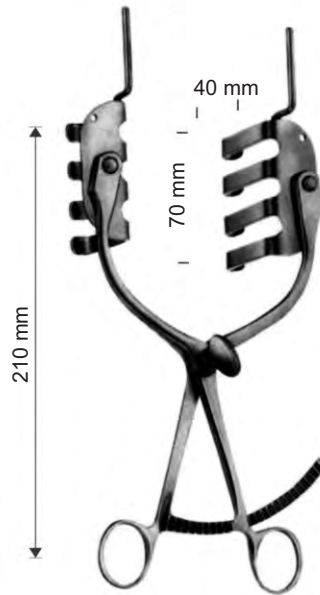

**ST.Marks.Modif,Girona**  
SS-19-300  
Perineal retractor with towel pegs  
fitted to swivel rake blades

**SS-18-275**  
(pair)  
lateral blades  
22 x 72 mm



**SS-18-276**  
frame only

**Park**  
SS-19-274



**Hill-Ferguson**  
SS-18-280 7/8" wide  
SS-18-281 1-3/16" wide  
SS-18-282 1-7/16" wide  
Rectal Retractor



**Sawyer**  
SS-18-290 1" wide  
SS-18-291 7/8" wide  
SS-18-292 1-1/4" wide  
Rectal Retractor

Max, Spread 115 mm



23 x 70 mm blade

**Smith-Buie**  
SS-18-301



# SAPTESTAR

Manufacturer & Exporter Of Surgical, Dental & Veterinary Instruments



+92-340-4040061



exportsaptestar@gmail.com



info@saptestar.com



www.saptestar.com



Defence Road, Near Hotel Javson, 51310-Sialkot Pakistan

