



Diagnostics 01

01 Diagnostic

Abraham	15
Amputation Knives	06
Aorta Punches	24
Ayre	17
Bergmann	03
Brunngs	15
Catlin	05
Catlin	07
Dieffenbach	03
Disecting Knives	01
Fower	15
Graefe	02
Halle	18
Joseph	16
Langenbeck	05
Langenbeck	06
Langenbeck	08
Liston	05
Masing	16
Olivecrona	15
Post Mortem Knives	09
Resection Amputation	11
Scalpel Handles	20
Scalpel Handles	21
Scalpel Handles	22
Scalpel Handles	23
Scalpel	19
Scalpels	04
Schink	25
Segond	17
Simon	17
Tonnis	18
Ulrich	17
Virchow	10
Virchow	13
Virchow	14
Walb	12
Ziegler	18



SAPTESTAR
Manufacturer & Exporter Of Surgical, Dental & Veterinary Instruments

Dissecting Knives
Bistouris para diseccion
Bistouris a dissection



With metal handle
con mango metálico
avec manche en métal

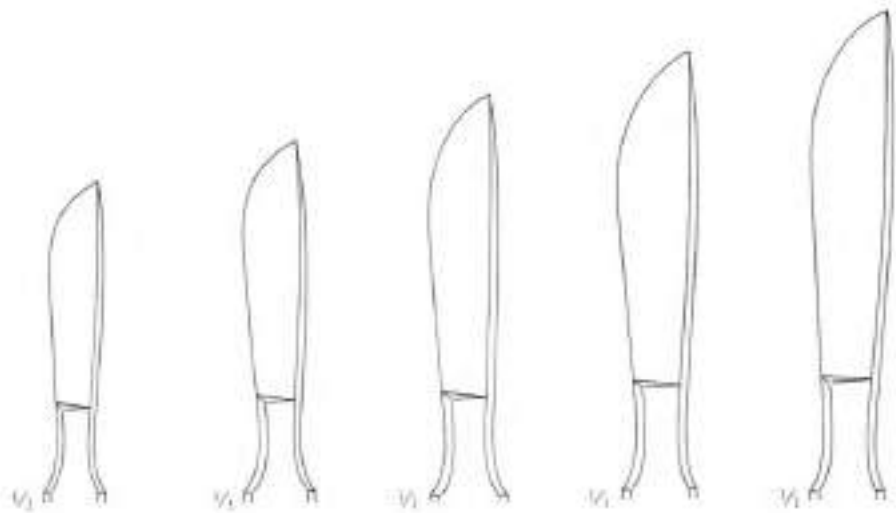

SS-01-101
Fig. 1
15 cm / 6"
30 mm



SS-01-102
Fig. 2
15 cm / 6"
36 mm



SS-01-103
Fig. 3
15.5 cm / 6"
40 mm



SS-01-104
Fig. 4
16 cm / 6¼"
45 mm



SS-01-105
Fig. 5
16 cm / 6¼"
50 mm

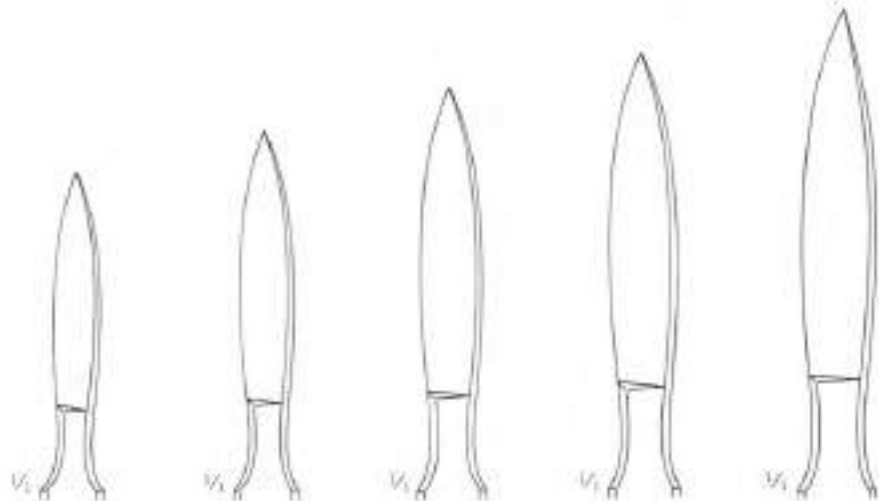

SS-01-106
Fig. 6
15 cm / 6"
27 mm



SS-01-107
Fig. 7
15 cm / 6"
35 mm



SS-01-108
Fig. 8
16 cm / 6¼"
40 mm



SS-01-109
Fig. 9
16 cm / 6¼"
47 mm



SS-01-110
Fig. 10
17 cm / 6¾"
50 mm





SS-01-111 SS-01-112

Graefe
 130 mm/ 5½"



SS-01-113 SS-01-114 SS-01-115

SS-01-116 SS-01-117 SS-01-118

130 mm/ 5½"

Scalpels
 Bisturies
 Bistouris



SS-01-128 SS-01-129 SS-01-130 SS-01-131 SS-01-132 SS-01-133 SS-01-134 SS-01-135 SS-01-136 SS-01-137



140 mm / 5½"
 175 mm / 7"



SS-01-138 SS-01-139 SS-01-140 SS-01-141 SS-01-142 SS-01-143 SS-01-144 SS-01-145 SS-01-146 SS-01-147

Tenotom
 Tenotome

Amputation Knives
Cuchillos para amputacion
Cuteaux a amputation



Liston
SS-01-148 130 mm / 5 $\frac{1}{8}$ "
SS-01-149 160 mm / 6 $\frac{1}{4}$ "
SS-01-150 190 mm / 7 $\frac{1}{2}$ "
SS-01-151 220 mm / 8 $\frac{3}{4}$ "
Length Of blade
Amputationsmesser
Amputation knives

Catlin
SS-01-152
160 mm / 6 $\frac{1}{4}$ "
Length Of blade
Amputationsmesser
Amputation knife

Langenbeck
SS-01-153
120 mm / 4 $\frac{3}{4}$ "
Length Of blade
Lappensmesser
Flap knife

Amputation Knives
Cuchillos para amputacion
Couteaux a amputation



SS-01-154
105 mm / 4 $\frac{1}{8}$ "
Length Of blade
Phalangenmesser
Phalangeal Knife



SS-01-155
110 mm / 4 $\frac{3}{8}$ "
Length Of blade
Zwischenknochen-messer
Interosseous knife

Double Cutting



SS-01-156
65 mm / 2 $\frac{1}{2}$ "
Length Of blade
Beinhatmesser
Mit Schaber
Periosteum knife
With Raspatory



SS-01-157



SS-01-158



Langenbeck
55 mm / 2 $\frac{1}{8}$ "
Length Of blade
Resektionsmesser
Resection knives

Amputation Knives
Cuchillos para amputacion
Couteaux a amputation



SS-01-159
29 cm / 11½"
With hollow handle
con mango hueco
avec manche creux



SS-01-160
32.5 cm / 12¾"
With hollow handle
con mango hueco
avec manche creux



Catlin
SS-01-161
29 cm / 11½"
With hollow handle
con mango hueco
avec manche creux

Resection Knives
 Cuchillos para reseccion
 Couteaux a resection



SS-01-162
 18 cm / 7"
 Solid handle, dissecting end
 mango macizo, con periostótomo
 manche solide á rugine



Langenbeck
SS-01-163
 18 cm / 7"

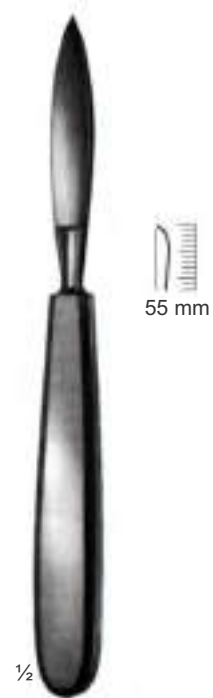

Langenbeck
SS-01-164
 18 cm / 7"

Post Mortem Knives
Cuchillos para autopsia
Bistouris a autopsie



SS-01-165
55 mm / 2 $\frac{1}{8}$ "
Length of blade
mit Schaber,
holzheft
with raspatory,
wooden handle



SS-01-166
55 mm / 2 $\frac{1}{8}$ "
Length Of blade
Metallheft
Metal handle



SS-01-167
70 mm / 2 $\frac{3}{4}$ "
Length of blade
Holzheft
Wooden handle

Post Mortem Knives
Cuchillos para autopsia
Bistouris a autopsie



1/2

Virchow
SS-01-168
85 mm / 3 3/8"
Length of blade
Metallheft
Metal handle



1/2

Virchow
SS-01-169
95 mm / 3 3/4"
Length of blade
Holzheft
Wooden handle



1/2

SS-01-170
115 mm / 4 1/2"
Length of blade
Holzheft
Wooden handle

Resection & Amputation Knives
Cuchillos para reseccion y amputacion
Couteaux a reseccion et amputation



SS-01-171
80 mm / 3 1/8"
Length of blade
Metallheft
Metal handle



SS-01-172
130 mm / 3 1/8"
Length of blade
Metallheft
Metal handle



SS-01-173
195 mm / 7 3/4"
Length of blade
Metallheft
Metal handle



SS-01-174
100 mm / 4"
Length of blade
Metallheft
Metal handle

Resection & Amputation Knives
Cuchillos para reseccion y amputacion
Couteaux a resection et amputation



SS-01-175
25.5 cm / 10"
With wooden handle
con mango de madera
avec manche en bois



SS-01-176
21 cm / 8¼"
With wooden handle
con mango de madera
avec manche en bois



Walb
With wooden handle
con mango de madera
avec manche en bois

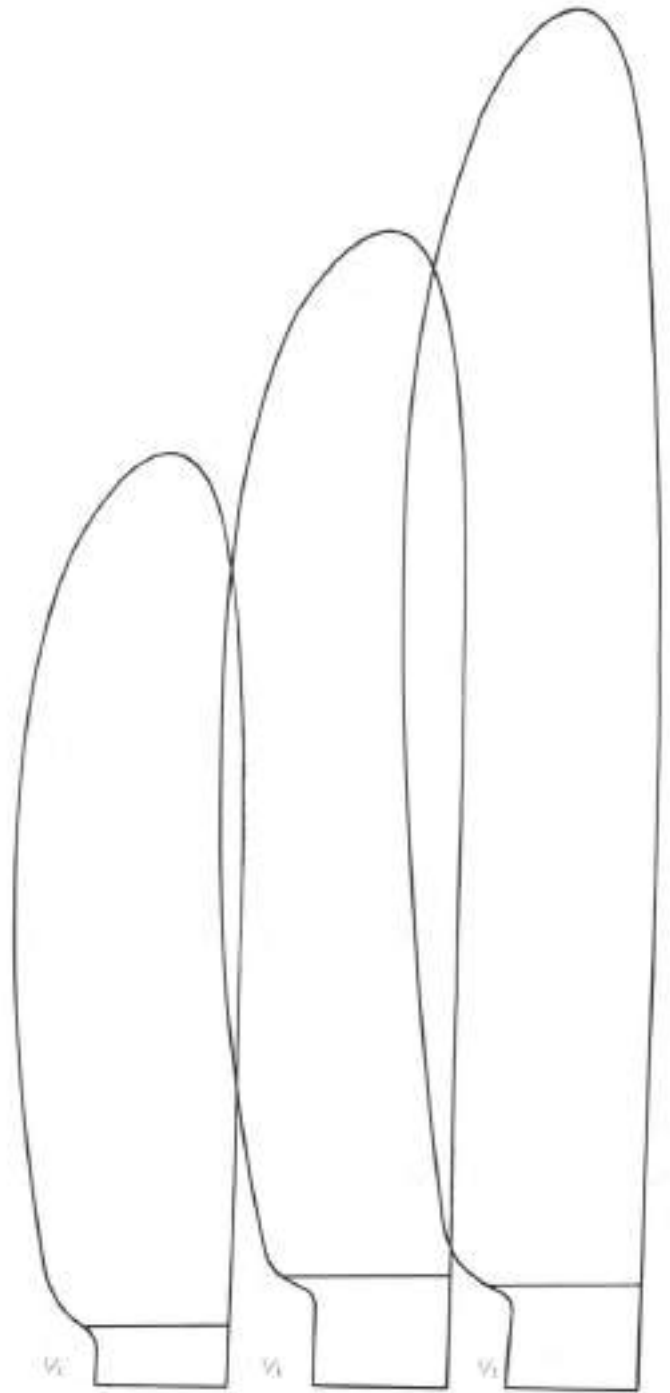

SS-01-177
26 cm / 10¼"
110 mm



SS-01-178
29 cm / 11½"
140 mm



SS-01-179
31 cm / 12¼"
170 mm



Resection & Amputation Knives
Cuchillos para reseccion y amputacion
Couteaux a resection et amputation



SS-01-180
110 cm / 4 $\frac{3}{4}$ "
Length of blade
Holzheft
Wooden handle



SS-01-181
170 cm / 6 $\frac{3}{4}$ "
Length of blade
Holzheft
Wooden handle



Virchow
SS-01-182
160 cm / 6 $\frac{1}{4}$ "
Length of blade
Metallheft
Metal handle



Virchow
SS-01-183
200 mm, 8"
Length of blade
Metallheft
Metal handle



Virchow
SS-01-184
240 mm, 9 $\frac{1}{2}$ "
Length of blade
Metallheft
Metal handle

Brain Knives
 Cuchillos para cerebro
 couteaux a cerveau



Virchow
 With hollow handle
 con mango hueco
 avec manche creux

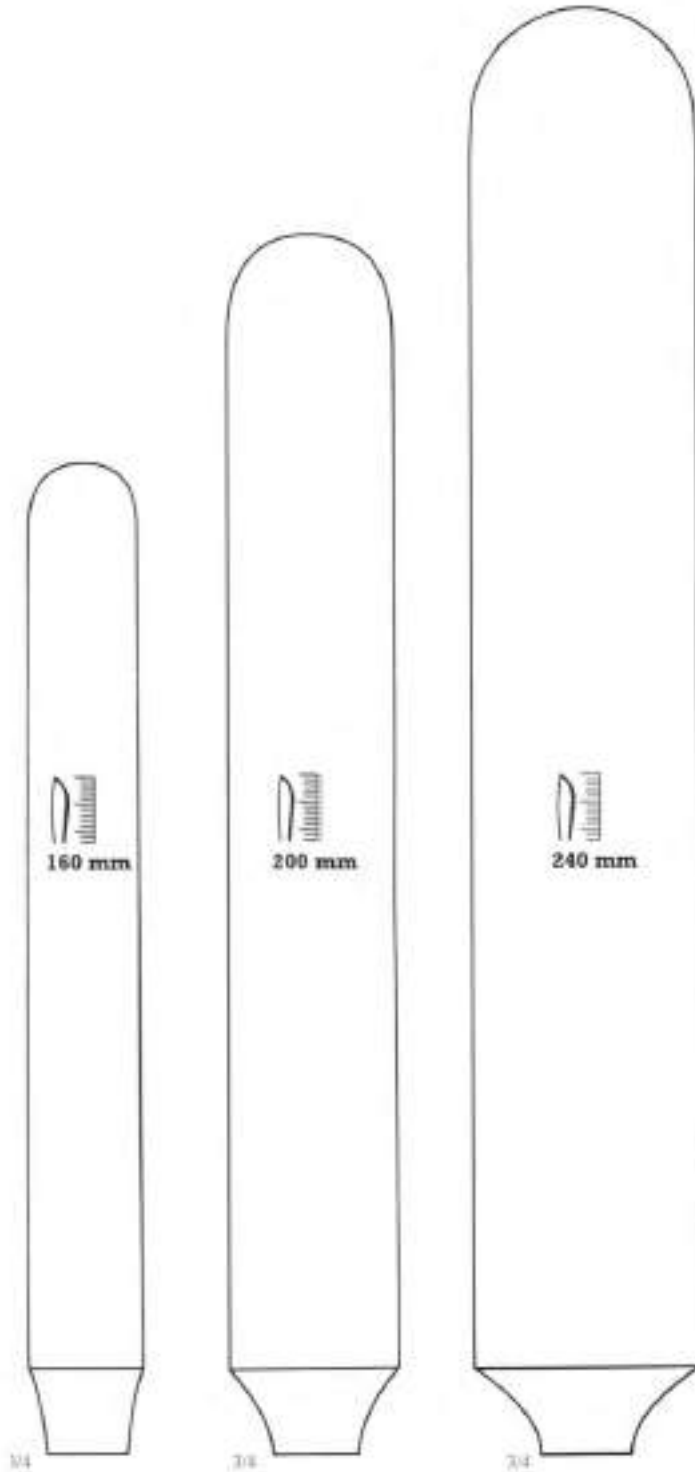

SS-01-185
 26 cm / 10¼"

SS-01-186
 33.5 cm / 13¼"

SS-01-187
 38 cm / 15"

Tergeminal Knives
Cuchillos para cerebro
Couteaux a cerveau



Olivecrona
SS-01-188
Trigeminal knife
205 mm / 8"



SS-01-189
Trigeminal knife
230 mm / 9"



Fowler
SS-01-190
Tonsil knife
200 mm / 8"



Abraham
SS-01-191
Tonsil knife
215 mm / 8½"



Brünings
SS-01-192
Tonsil knife
215 mm / 8½"

Scalpels
 Bisturies
 Bistouries



Masing
SS-01-193
 Cartilage slitting knife,
 curved blade, pointed
 130 mm / 5"



SS-01-194
 Abscess knife
 130 mm / 5 1/8"



Joseph
SS-01-195 straight
SS-01-196 curved
 double-edged nasal knives, pointed
 145 mm / 5 3/4"



SS-01-195



SS-01-196



1/4

Fistula knives
Bisturies para Fistulas
Bistouries pour Fistules



Simon
Fistula knives
200 mm / 8"

Ulrich
SS-01-200
Fistula knife
225 mm / 9"

Ayre
SS-01-201
Cone knife
235 mm / 9 1/4"

SS-01-202
Cone knife
230 mm / 9"

Second
SS-01-203
Myomatome
270 mm / 10 1/2"

Dura knives
 Cuchillos p. Dura-madre
 Couteaux pour dure-mere



SS-01-204 SS-01-205

Ziegler
SS-01-204 small
SS-01-205 pointed
 Milienmesser
 Milium knives
 120 mm / 4¾"



Tönnis
SS-01-206
 Duramesser
 Dura knife
 130 mm / 5"



Tönnis
SS-01-207
 Duramesser
 Dura knife
 190 mm / 7½"



Halle
SS-01-208
 Duramesser
 Dura knife
 210 mm / 8¼"

Scalpel Handles
 Mangos de bisturi
 Manches pour bistouris



Fig. 18-36

SS-01-209
 13.5 cm / 5¼"
 No. 4
 Solid
 Macizo
 Solide



Fig. 10-36

SS-01-210
 16 cm / 6¼"
 No. 3 & 4
 Solid, double ended
 Macizo, doble extremo
 Solide, double



Fig. 18-36

SS-01-211
 21 cm / 8¼"
 No. 4L
 Solid, long
 Macizo, largo
 Solide, long



Fig. 18-36

SS-01-212
 21 cm / 8¼"
 No. 4L
 Solid, angled, long
 Macizo, angulado, largo
 Solide, coude, long

Scalpel Handles
Mangos de bisturi
Manches pour bistouris



Fig. 10-17

SS-01-218
No. 7
16 cm / 6¼"
solid
macizo
solide



Fig. 10-17

SS-01-219
No. 7K
12.5 cm / 5"
Solid, short
macizo, corto
solide, court



Fig. 10-17

SS-01-220
No. 3
15.5 cm / 6"
With round hollow handle
con mango hueco redondo
avec manche creux rond



Fig. 10-17

SS-01-221
No. 3
12.5 cm / 5"
With plastic handle
con mango plastico
avec manche en matiere plastique

Scalpel Handles
Mangos de bisturi
Manches pour bistouris



Fig. 18-36

SS-01-222
No. 8
13.5 cm / 5¼"
with hollow handle
con mango hueco
avec manche creux



Fig. 18-36

SS-01-223
No. 9
14.5 cm / 5¾"
with hollow handle
con mango hueco
avec manche creux



Fig. 18-36

SS-01-224
No. 4
13.5 cm / 5¼"
with plastic handle
con mango plastico
avec manche en matiere plastique



SS-01-225
No. 3
14.5 cm / 5³/₄"
solid, round
macizo, redondo
solide, rond



SS-01-226
No. 3
14 cm / 5¹/₂"
Solid, round, angled
macizo, redondo, angulado
solide, rond, coude



Kaye
SS-01-227
No 3
15 cm / 6"
Solid, round
redondo
solide, rond



SS-01-228
13.5 cm / 5¹/₄"
For micro scalpel blades
para micro hojas
pour micro-lame de bisturis



SS-01-229
13.5 cm / 5¹/₄"

Aorta Punches
Perforadores aorticos
Rongeurs pour aorte



SS-01-236
16 cm / 6¼"
Cutting diameter 4 mm
diametro del corte 4 mm
diametro du tranchant 4 mm



SS-01-237
16 cm / 6¼"
Cutting diameter 5 mm
diametro del corte 5 mm
diametre du tranchant 5 mm

Aorta Punches

Percussion Hammers
 Martillos de percusion y para reflejos
 Marteaux a percussion et a reflexe



Taylor
SS-01-238 18 cm / 7"
SS-01-239 20 cm / 8"



Berliner
SS-01-240
 20 cm / 8"



Dejerine
SS-01-241
 20 cm / 8"



Dejerine
SS-01-242
 21.5 cm / 8½"
 with needle
 con aguja
 avec aiguille

Percussion Hammers
Martillos de percusion y para reflejos
Marteaux a percussion et a reflexe



Buck
SS-01-243
18 cm / 7"
Hammer for neurological examination, with brush & needle
Martillo para exámenes neurológicos, con cepillo y aguja
Marteau avec brosse et aiguille pour examens neurologiques

Rabiner
SS-01-244
23.5 cm / 9¼"
Hammer for neurological examination, with brush & needle
Martillo para exámenes neurológicos, con cepillo y aguja
Marteau avec brosse et aiguille pour examens neurologiques

Troemner
SS-01-245
23 cm / 9"



TC Scissors 02

02 TC Scissors

Caplan	15
Cottle	14
De Bakey	12
Dean	11
Fomon	14
Goldmann-Fox	11
Gorney	15
Hegemann-Dietrich	13
Heymann	14
Iris Scissor Angular	01
Iris Scissor	01
Joseph	01
Kelly	01
Knight	14
Lexer	04
Locklin	11
Mayo	03
Mayo-Lexer	05
Mayo-stille	05
Metzenbaum	04
Metzenbaum	06
Metzenbaum	07
Metzenbaum	08
Metzenbaum	10
Metzenbaum-Thorek	10
Nelson- Metzenbaum	09
Oprating Scissor	02
Potts-Smith	13
Ragnell	04
Sims	16
Toennis-Adson	04
Disecting Scissors	1,3,9
Gum Scissors	11
Surgical Scissors	02
Vascular Scissors	12,13

Dissecting Scissors with tungsten carbide edges
Tijeras Finas con filos de carbure tungsteno
Ciseaux Fins avec des lames en tungstene



SS-02-101
11.5 cm

Iris Scissors

Iris Scissors
Tijeras para iridectomía
Ciseaux á iridectomie



SS-02-102
11.5 cm



Angular

Iris Scissors
SS-02-103
11 cm

Iris Scissors
Tijeras para iridectomía
Ciseaux á iridectomie

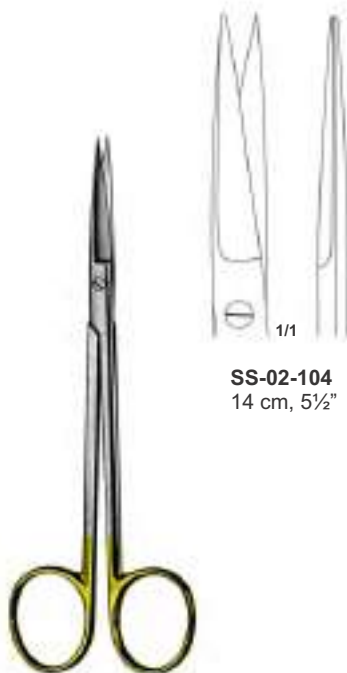

SS-02-104
14 cm, 5½"

JOSEPH

Plastic surgery scissors
Tijeras para la cirugía plástica
Ciseaux pour la chirurgie plastique



SS-02-105
14 cm, 5½"

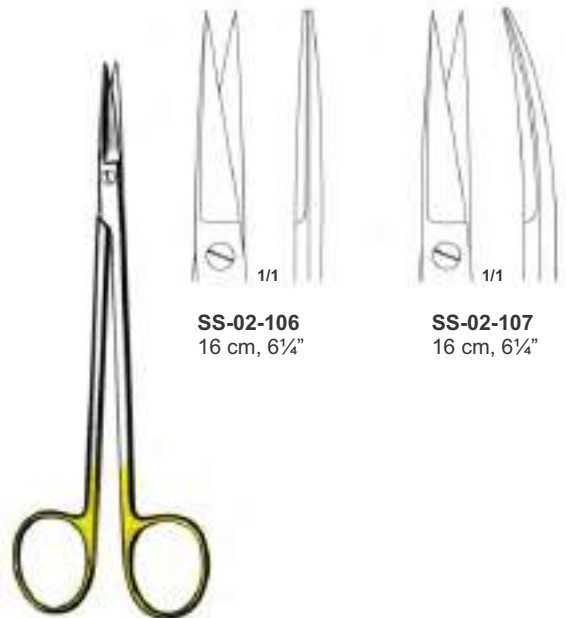

SS-02-106
16 cm, 6¼"

SS-02-107
16 cm, 6¼"

KELLY

Vascular and fistula scissors
Tijeras para vasos y fistulas
Ciseaux vasculaires et pour fistules



SAPTESTAR
Manufacturer & Exporter Of Surgical, Dental & Veterinary Instruments

Surgical Scissors with tungsten carbide edges
Tijeras Para Cirugia con filos de carbure tungsteno
Ciseaux a Chirurgie avec des lames en tungstene

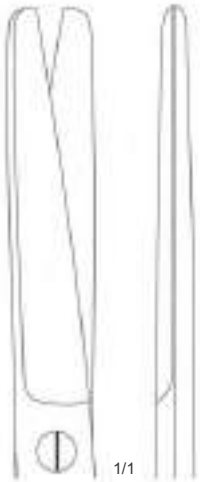

SS-02-108
14.5 cm, 5³/₄"

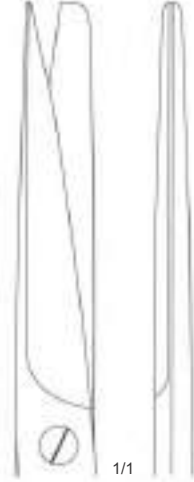

SS-02-110
14.5 cm, 5³/₄"

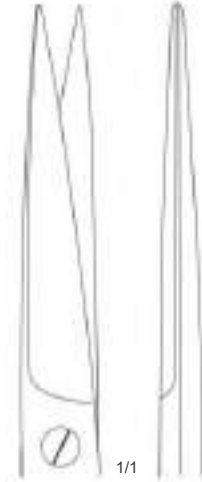

SS-02-112
14.5 cm, 5³/₄"

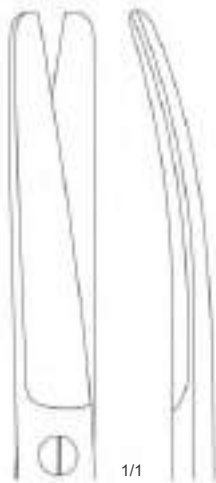

SS-02-109
14.5 cm, 5³/₄"

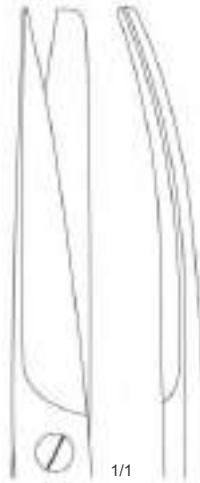

SS-02-111
14.5 cm, 5³/₄"



SS-02-113
14.5 cm, 5³/₄"



1/2

Blunt / Blunt
Standrad patterns
modelos standrad
modèles standrad



1/2

Sharp / Blunt
Standrad patterns
modelos standrad
modèles standrad



1/2

Sharp / Sharp
Standrad patterns
modelos standrad
modèles standrad

Dissecting Scissors with tungsten carbide edges
Tijeras de Diseccion con filos de carbure tungsteno
Ciseaux a Diseccion avec des lames en tungstene

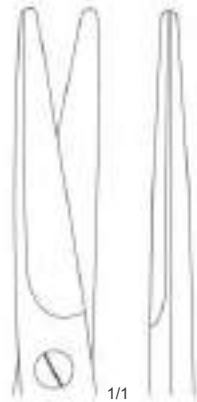

SS-02-114
14.5 cm, 5¾"

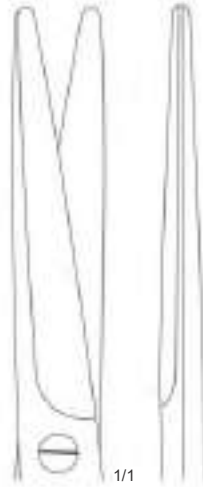

SS-02-116
17 cm, 6¾"

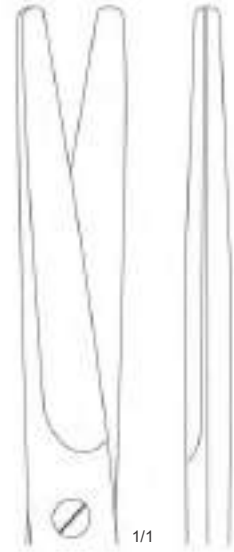

SS-02-118
23 cm, 9"

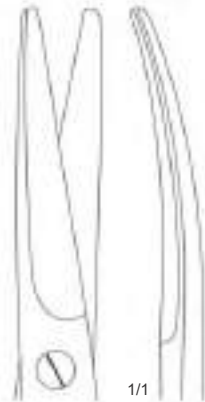

SS-02-115
14.5 cm, 5¾"

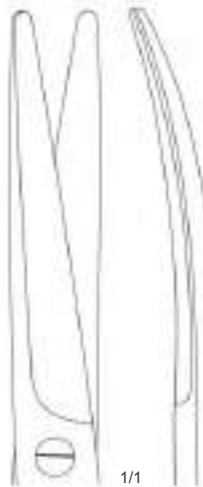

SS-02-117
17 cm, 6¾"

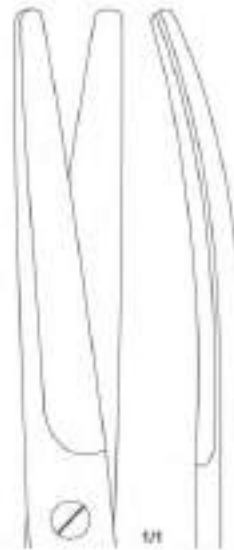

SS-02-119
23 cm, 9"



MAYO



SAPTESTAR
Manufacturer & Exporter Of Surgical, Dental & Veterinary Instruments

Dissecting Scissors with tungsten carbide edges
Tijeras de Diseccion con filos de carbure tungsteno
Ciseaux a Diseccion avce des lames en tungstene



RAGNELL



SS-02-120
12.5 cm, 5"



SS-02-121
12.5 cm, 5"



LEXER

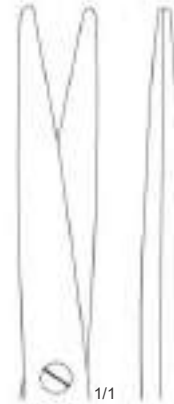

SS-02-122
16 cm, 6 1/4"

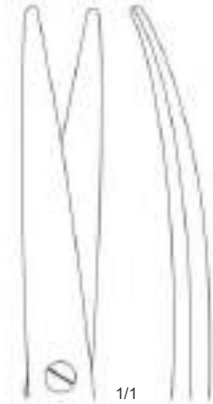

SS-02-123
16 cm, 6 1/4"



TOENNIS-ADSON



SS-02-124
17.5 cm, 7"



SS-02-125
17.5 cm, 7"



METZENBAUM



SS-02-126
17.5 cm, 7"



SS-02-127
17.5 cm, 7"

Dissecting Scissors with tungsten carbide edges
Tijeras de Diseccion con fillos de carbure tungsteno
Ciseaux a Dissecting avce des lames en tungstene



MAYO-STILLE

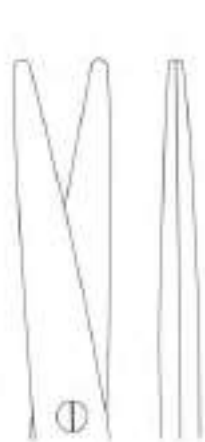

SS-02-128
14.5 cm, 5¾"

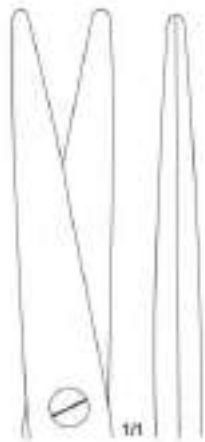

SS-02-129
17 cm, 6¾"

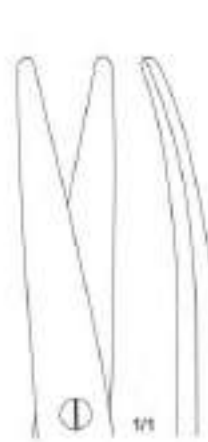

SS-02-130
14.5 cm, 5¾"

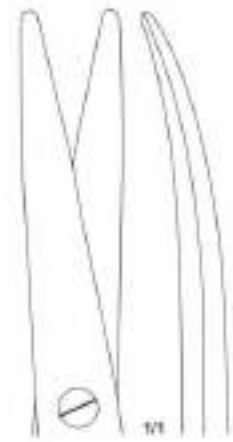

SS-02-131
17 cm, 6¾"



MAYO HEALY

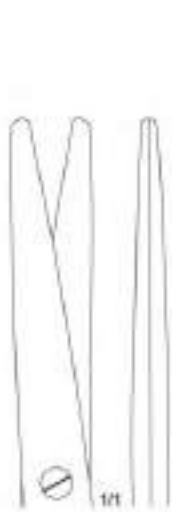

SS-02-132
16 cm, 6¾"

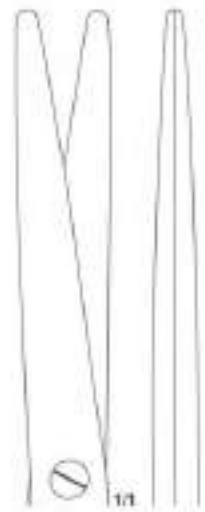

SS-02-133
21 cm, 8¾"

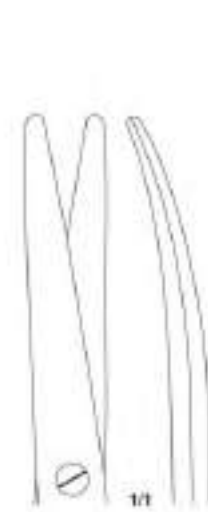

SS-02-134
16 cm, 6¾"

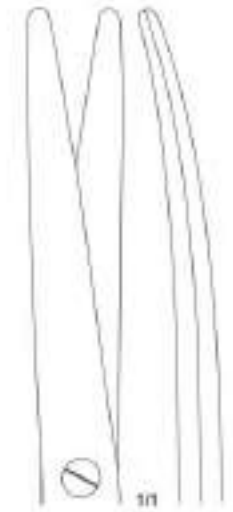

SS-02-135
21 cm, 8¾"



SAPTESTAR
Manufacturer & Exporter Of Surgical, Dental & Veterinary Instruments

Dissecting Scissors with tungsten carbide edges
Tijeras de Diseccion con fillos de carbure tungsteno
Ciseaux a Dissecting avce des lames en tungstene

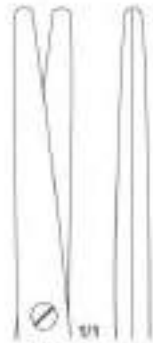

SS-02-136
14.5 cm



SS-02-137
18 cm

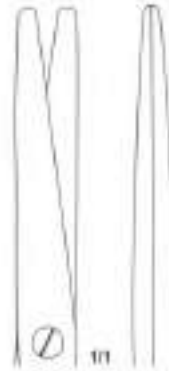

SS-02-138
20.5 cm

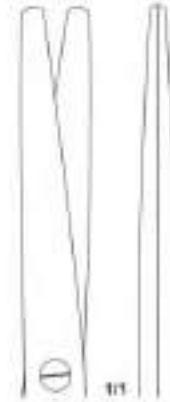

SS-02-139
23 cm

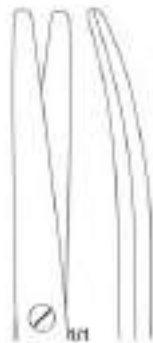

SS-02-140
14.5 cm



SS-02-141
18 cm

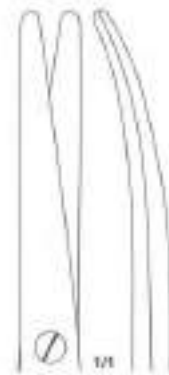

SS-02-142
20.5 cm

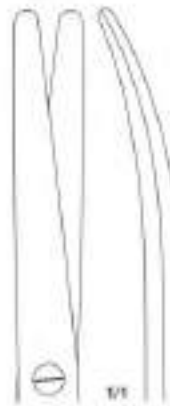

SS-02-143
23 cm



Metzenbaum
Standard patterns
modelos standard
modèles standard

Dissecting Scissors with tungsten carbide edges
Tijeras de Diseccion con fillos de carbure tungsteno
Ciseaux a Dissecting avce des lames en tungstene

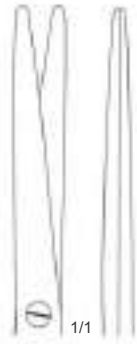

SS-02-144
14.5 cm



SS-02-145
18 cm

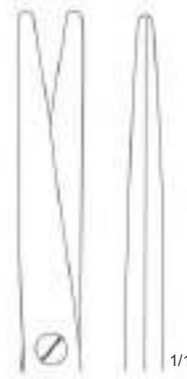

SS-02-146
20.5 cm

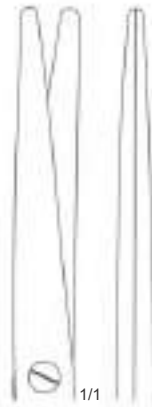

SS-02-147
23 cm



SS-02-148
14.5 cm



SS-02-149
18 cm



SS-02-150
20.5 cm

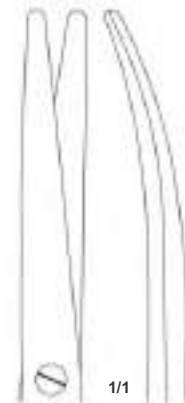

SS-02-151
23 cm



Metzenbaum
delicate patterns
modelos finos
modèles fins



SAPTESTAR
Manufacturer & Exporter Of Surgical, Dental & Veterinary Instruments

Dissecting Scissors with tungsten carbide edges
Tijeras de Diseccion con filos de carbure tungsteno
Ciseaux a Dissecting avce des lames en tungstene

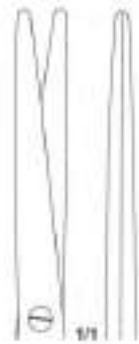

SS-02-152
14.5 cm, 5 $\frac{3}{4}$ "



SS-02-153
18 cm, 7"

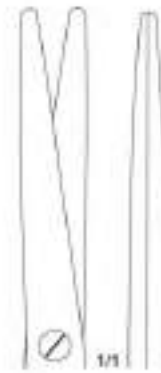

SS-02-154
20.5 cm, 8"

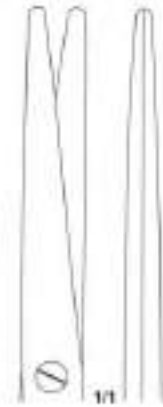

SS-02-155
23 cm, 9"



SS-02-156
14.5 cm, 5 $\frac{3}{4}$ "

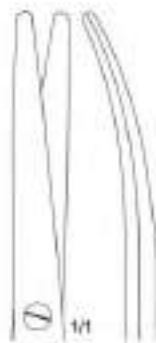

SS-02-157
18 cm, 7"

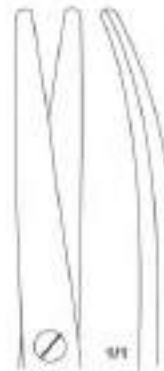

SS-02-158
20.5 cm, 8"

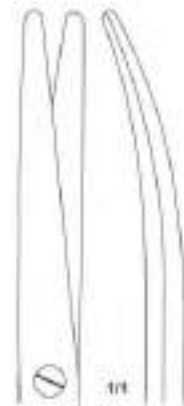

SS-02-159
23 cm, 9"



Metzenbaum
very delicate patterns
modelos muy finos
modèles très fino

Dissecting Scissors with tungsten carbide edges
Tijeras de Diseccion con filos de carbure tungsteno
Ciseaux a Dissecting avce des lames en tungstene

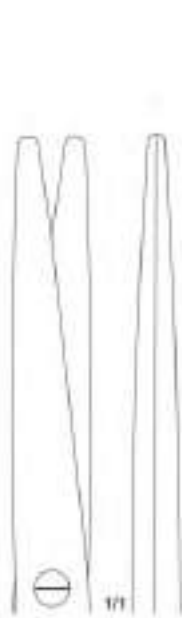

BC-02-160 26.0 cm, 10¼"
SS-02-161 28.0 cm, 11¼"

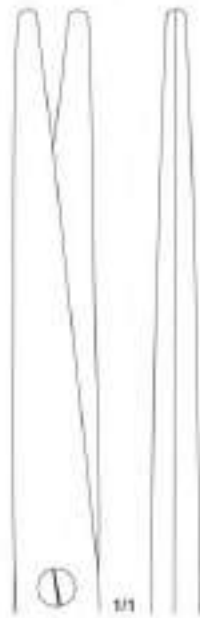

WI-02-162
31 cm, 12¼"



BC-02-166 26.0 cm, 10¼"
SS-02-167 28.0 cm, 11¼"



SS-02-163 26.0 cm, 10¼"
SS-02-164 28.5 cm, 11¼"

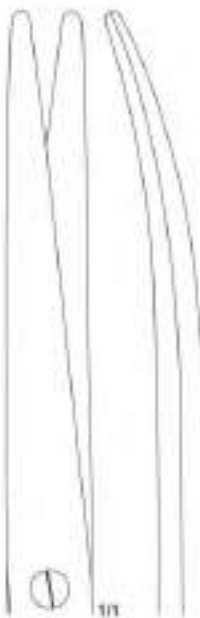

SS-02-165
31 cm, 12¼"



SS-02-168 26.0 cm, 10¼"
SS-02-169 28.5 cm, 11¼"

Nelson-Metzenbaum
Standard patterns
modelos standard
modèles standard

Nelson-Metzenbaum
delicate patterns
modelos finos
modèles fino



SAPTESTAR
Manufacturer & Exporter Of Surgical, Dental & Veterinary Instruments

Scissors with tungsten carbide edges
Tijeras con filos de carburo tungsteno
Ciseaux avec des lames en tungstene



Metzenbaum



SS-02-170
18 cm, 7"

Dissecting Scissors

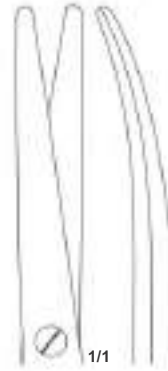

SS-02-171
20.5 cm, 8"

Tijeras de diseccion

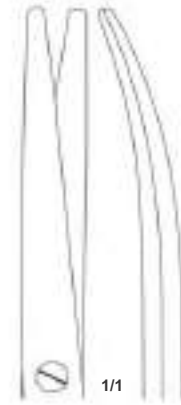

SS-02-172
23 cm, 9"

Ciseaux à dissection

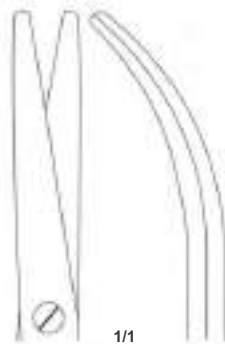

SS-02-173
20 cm, 8"

Adnex Scissors

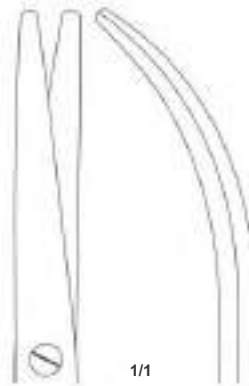

SS-02-174
22.5 cm, 9"

Tijeras adnex

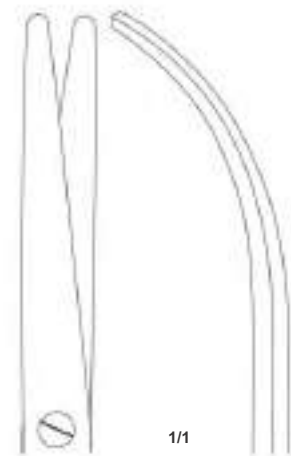

SS-02-175
27.5 cm, 10¾"

Ciseaux adnex

Gum Scissors with tungsten carbide edges
Tijeras para encias con fillos de carbure tungsteno
Ciseaux pour gencias avce des lames en tungstene



Goldmann-Fox



SS-02-176
13 cm, 5 1/8"



SS-02-177
13 cm, 5 1/8"



SS-02-178
13 cm, 5 1/8"



SS-02-179
13 cm, 5 1/8"



Goldmann-Fox

1 blade serrated
1 blade dentada
1 lame dentelée



Locklin
SS-02-180



16 cm, 6 1/4"
1 blade serrated
1 hoja dentada
1 lame dentelée

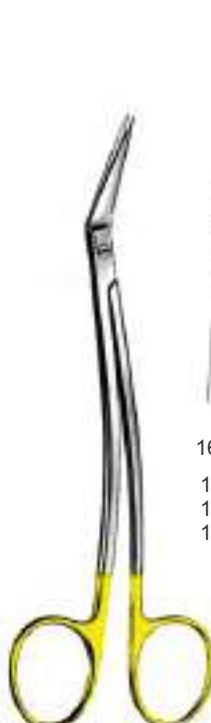

Locklin
SS-02-181



16 cm, 6 1/4"
1 blade serrated
1 hoja dentada
1 lame dentelée



Dean
SS-02-182

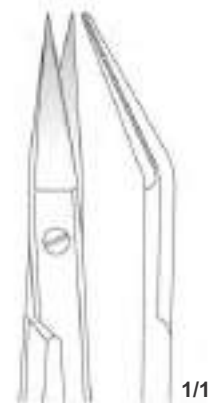

17 cm, 6 3/4"
1 blade serrated
1 hoja dentada
1 lame dentelée



SAPTESTAR
Manufacturer & Exporter Of Surgical, Dental & Veterinary Instruments

Vascular Scissors with tungsten carbide edges
Tijeras Vasculares con filos de carbure tungsteno
Ciseaux Vasculaires avec des lames en tungstene



SS-02-183
19 cm, 7½"



SS-02-186
23 cm, 9"



SS-02-184
18.5 cm, 7½"



SS-02-187
22.5 cm, 9"



De Bakey



BC-02-185
18 cm, 7"

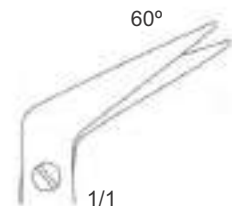

BC-02-188
22 cm, 8¾"



De Bakey

Vascular Scissors with tungsten carbide edges
Tijeras Vasculares con filos de carbure tungsteno
Ciseaux Vasculaires avec des lames en tungstene



SS-02-189
18 cm, 7"



SS-02-190
18 cm, 7"



SS-02-194
19 cm, 7½"

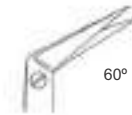

SS-02-191
17.5 cm, 7"

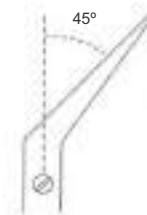

SS-02-195
18.5 cm, 7¼"



SS-02-192
17 cm, 6¾"

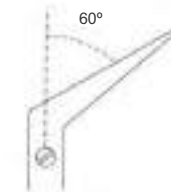

SS-02-196
18 cm, 7"



SS-02-193
17 cm, 6¾"



Hegemann-Dietrich



Potts-Smith



SAPTESTAR
Manufacturer & Exporter Of Surgical, Dental & Veterinary Instruments

Nasal Scissors with tungsten carbide edges
Tijeras nasales con filos de carbure tungsteno
Ciseaux nasaux avec des lames en tungstene



1 blade serrated
1 hoja dentada
1 lame dentelée

KNIGHT
WI-02-197
17.5 cm, 7"

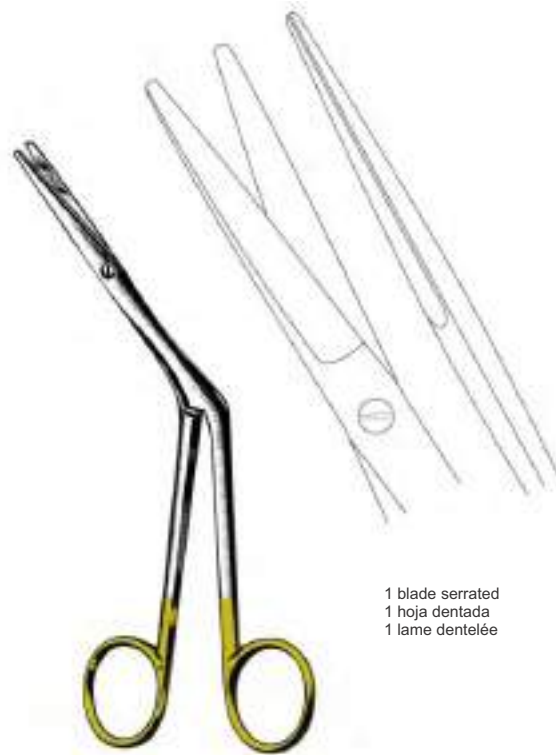

1 blade serrated
1 hoja dentada
1 lame dentelée

HEYMANN
WI-02-198
18.5 cm, 7 1/4"



1 blade serrated
1 hoja dentada
1 lame dentelée

WI-02-199
18.5 cm, 7 1/4"



1 blade serrated
1 hoja dentada
FONON

COTTLE
WI-02-200
18.5 cm, 7 1/4"

Scissors with tungsten carbide edges
Tijeras con filos de carbure tungsteno
Ciseaux avec des lames en tungstene



Caplan
SS-02-201
20 cm, 8"



Septum scissors, serrated
Tijera para el tabique nasal, dentada
Ciseaux dentelés pour septum



Gorney
SS-02-202
21.5 cm, 8½"



Septum scissors, serrated
Tijera para el tabique nasal, dentada
Ciseaux dentelés pour septum



SAPTESTAR
Manufacturer & Exporter Of Surgical, Dental & Veterinary Instruments

Gynecology Scissors with tungsten carbide edges
Tijeras para ginecologia con filos de carbure tungsteno
Ciseaux pour gynecologie avec des lames en tungstene



Sims

1/2



BC-02-203
23 cm, 9"



BC-02-204
20 cm, 8"



BC-02-205
20 cm, 8"

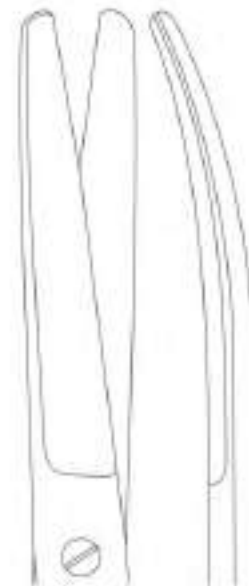

BC-02-206
23 cm, 9"

Uterine scissors

Tijeras uterinas

Ciseaux utérins

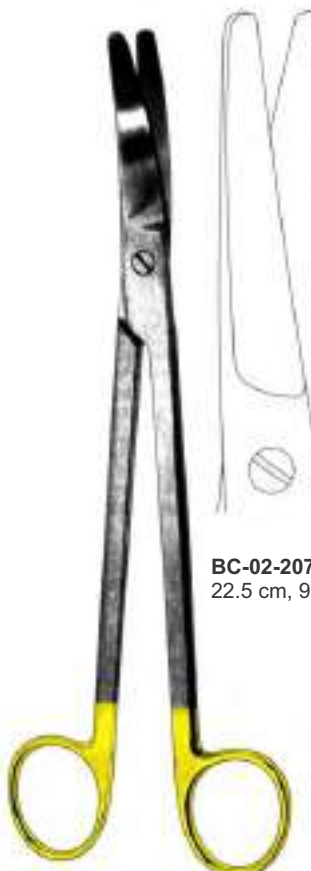

1/2



BC-02-207
22.5 cm, 9"



BC-02-208
22.5 cm, 9"



BC-02-209
22 cm, 8 3/4"



BC-02-210
22 cm, 8 3/4"

Parametrium scissors
Tijeras parametrium
Ciseaux á ligaments larges

1 blade serrated
1 hoja dentada
1 lame dentelee

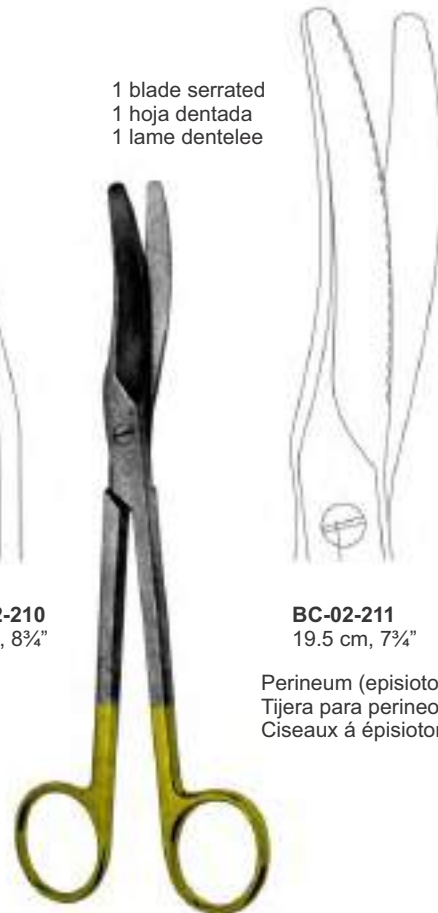

BC-02-211
19.5 cm, 7 3/4"

Perineum (episiotomy) scissors
Tijera para perineo (para episiotomia)
Ciseaux á épiotomie

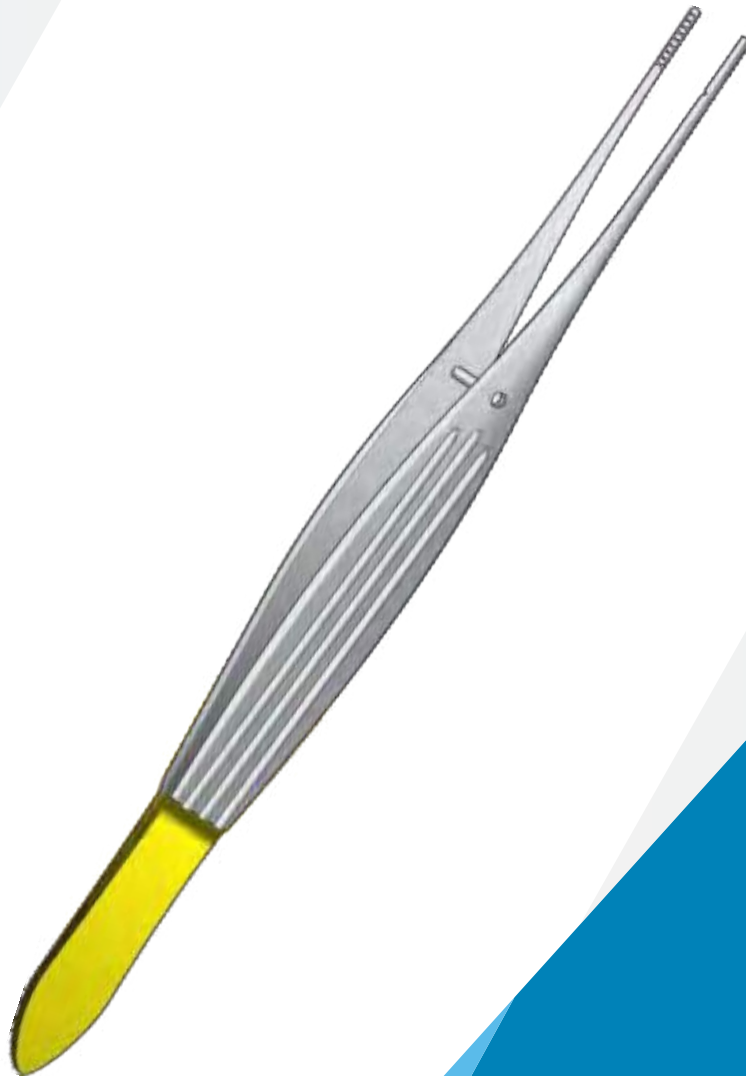

TC Forceps 03

03 TC Forceps

Adson Delicate	02
Adson Micro	02,07
Adson Par Style	02
Adson	02,07,13
Adson-Brown	07
Baker Mod. (bonney)	10
Bonney	06
Cushing Micro	03
Cushing	03,08
Cushing-Potts	03
Delicate	09
Evans	05
Ferris-Smith	10
Gerald Milcro	03
Gerald	03,08
Gillies	09
Leibinger	13
Leibinger-Debakey	11,12
Leibinger-Williams	09
Mc Indoe	05
Obwegeser	05
Potts-Smith Micro	MICRO05
Potts-Smith	05
Rees Bayonet	06
Semkin Micro	08
Semkin	08
Skinner Kelicate	09
Skinner Micro	09
Skinner	09
Standard Delicate	04
Standard0	04,10
Thorlakson	13
Tickner	06
Uda Mod.	05
Wangensteen	06
Wheeler	13
Disectting Forceps	20,24
Tissue Forceps	25,30

Forceps with tungsten carbide edges
Pinzas con filos de carbure tungsteno
Pincas avce des lames en tungstene

- Wide selection of patterns for use in all types of surgical procedures
- safe and secure grasping of finest tissue
- precisely machined and hand-crafted for longlasting performance
- gold-plated ends for easy identification



Serrations: 0.5 mm

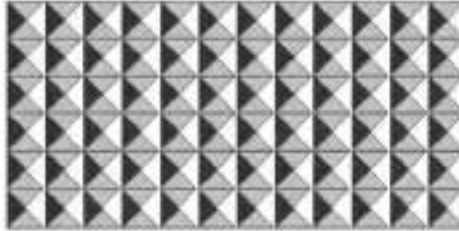

REGULAR

This tooth size is ideal for use in standard pattern needle holders like Mayo-Hegar, Mathieu, Bozeman a.o. And in needle-pulling tissue forceps. For holding large needles with sutures sized 3-0 and larger.

Serrations: 0.4 mm

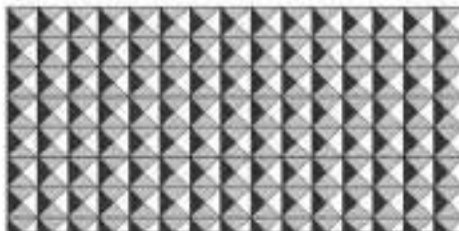

FINE

Best for use in needle holders such as Crile-Wood, DeBakey, Ryder, a.o. And in delicate needle pulling tissue forceps. For holding needles and sutures between 4-0 and 6-0.

Serrations: 0.65 mm

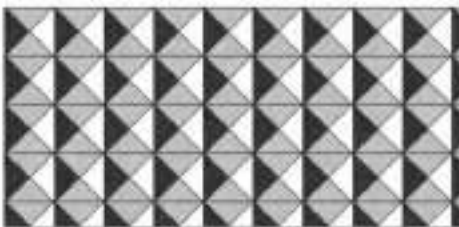

COARSE

This coarsely serrated insert is placed in the most powerful needle holder patterns and wire twisters and assures maximum holding ability when using heavy needles or surgical wire.

Serrations: 0.2 mm

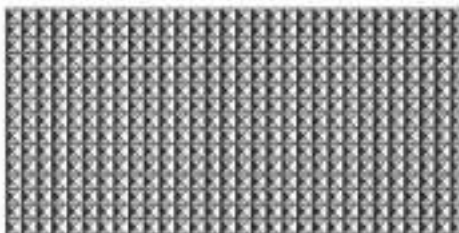

MICRO

This micro size is extremely effective for use in microsurgical needle holders like Castroviejo, Mini-Ryder, Microvascular, Lemmon and other microoriented needle holders. For use with the most delicate needles and sutures from size 7-0 to 10-0. Excellent delicate needle holding ability without minimal damage to needle or suture.



SMOOTH

The smooth insert is designed to hold the smaller suture sizes without damage to the suture or needle. Its needle holding ability is somewhat limited, however. Used primarily in needle holders for plastic surgery and microsurgery.



SAPTESTAR
Manufacturer & Exporter Of Surgical, Dental & Veterinary Instruments

Dissecting Forceps with tungsten carbide edges
Pinzas de diseccion con fillos de carbure tungsteno
Pinces a dissection avce des lames en tungstene



Adson



Adson Par Style

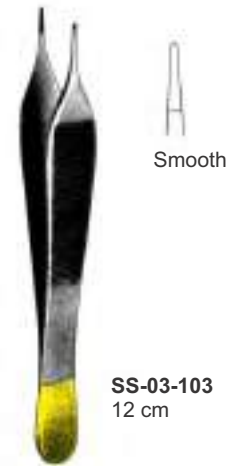

Adson Delicate



Adson



Adson Micro



Dissecting Forceps with tungsten carbide edges
Pinzas de diseccion con filos de carbure tungsteno
Pincas a dissection avce des lames en tungstene



1.8 mm



Regular
SS-03-107
18 cm

Cushing-Potts



1.8 mm



Regular
SS-03-108
18 cm

Cushing



Fine
SS-03-109
18 cm

Cushing Micro



1.8 mm



Fine
BC-03-110
18 cm
With lock

Cushing



1.8 mm



Regular
SS-03-111
18 cm

Cushing



Fine
SS-03-112
17.5 cm

Gerald



Fine
SS-03-113
17.5 cm

Gerald Micro



SAPTESTAR
Manufacturer & Exporter Of Surgical, Dental & Veterinary Instruments

Dissecting Forceps with tungsten carbide edges
Pinzas de diseccion con fillos de carbure tungsteno
Pinces a dissection avce des lames en tungstene



Dissecting Forceps with tungsten carbide edges
 Pinzas de diseccion con filos de carbure tungsteno
 Pincas a dissection avce des lames en tungstene



Regular
SS-03-122 15 cm

USA Mod.



Regular
BC-03-123 18 cm
SS-03-124 21 cm
SS-03-125 24.5 cm

Potts-smith



Fine
SS-03-126 21 cm

Potts-smith Micro



Regular
SS-03-127 25.5 cm

Evans



Fine
SS-03-128 15 cm

Mc Indoe



BC-03-129 16 cm
SS-03-130 18 cm

Obwegeser



SAPTESTAR
Manufacturer & Exporter Of Surgical, Dental & Veterinary Instruments

Dissecting Forceps with tungsten carbide edges
Pinzas de diseccion con fillos de carbure tungsteno
Pinces a dissection avce des lames en tungstene



Regular
BC-03-131 14.5 cm
SS-03-132 19.5 cm

Tickner



Coarse
SS-03-133 17 cm

Bonney



Regular
BC-03-134 15.5 cm
SS-03-135 23 cm
SS-03-136 25.5 cm

Wangensteen



Regular

SS-03-137 13.5 cm



Regular

SS-03-138 15.5 cm

Rees Ravnødt



Regular

BC-03-139 19.5 cm
SS-03-140 23.5 cm

Rees Ravnødt



Tissue Forceps with tungsten carbide edges
Pinzas quirurgicas con filos de carbure tungsteno
Pinces a dissection a griffes avec des lames en tungstene



Regular
SS-03-141 12 cm

Adson



3 x 4 Teeth



Regular
SS-03-142 12 cm

Adson-Brown



SS-03-143 12 cm

Adson Micro



Regular
SS-03-144 15 cm

Adson



3 x 4 Teeth



Regular
SS-03-145 15 cm

Adson-Brown



Fine
SS-03-146 15 cm



SAPTESTAR
Manufacturer & Exporter Of Surgical, Dental & Veterinary Instruments

Tissue Forceps with tungsten carbide edges
Pinzas quirurgicas con fillos de carbure tungsteno
Pinces a dissection a griffes avec des lames en tungstene



Semkin



Regular

BC-03-147 14.5 cm
SS-03-148 16 cm



Semkin Micro



Fine

BC-03-149 14.5 cm
SS-03-150 16 cm



Semkin Micro



Fine

SS-03-151 18 cm



Gerald



Regular

SS-03-152 17.5 cm



Gerald



Regular

SS-03-153 17.5 cm



Cushing



Regular

SS-03-154 18 cm

Tissue Forceps with tungsten carbide edges
 Pinzas quirurgicas con filos de carbure tungsteno
 Pincas a dissection a griffes avce des lames en tungstene

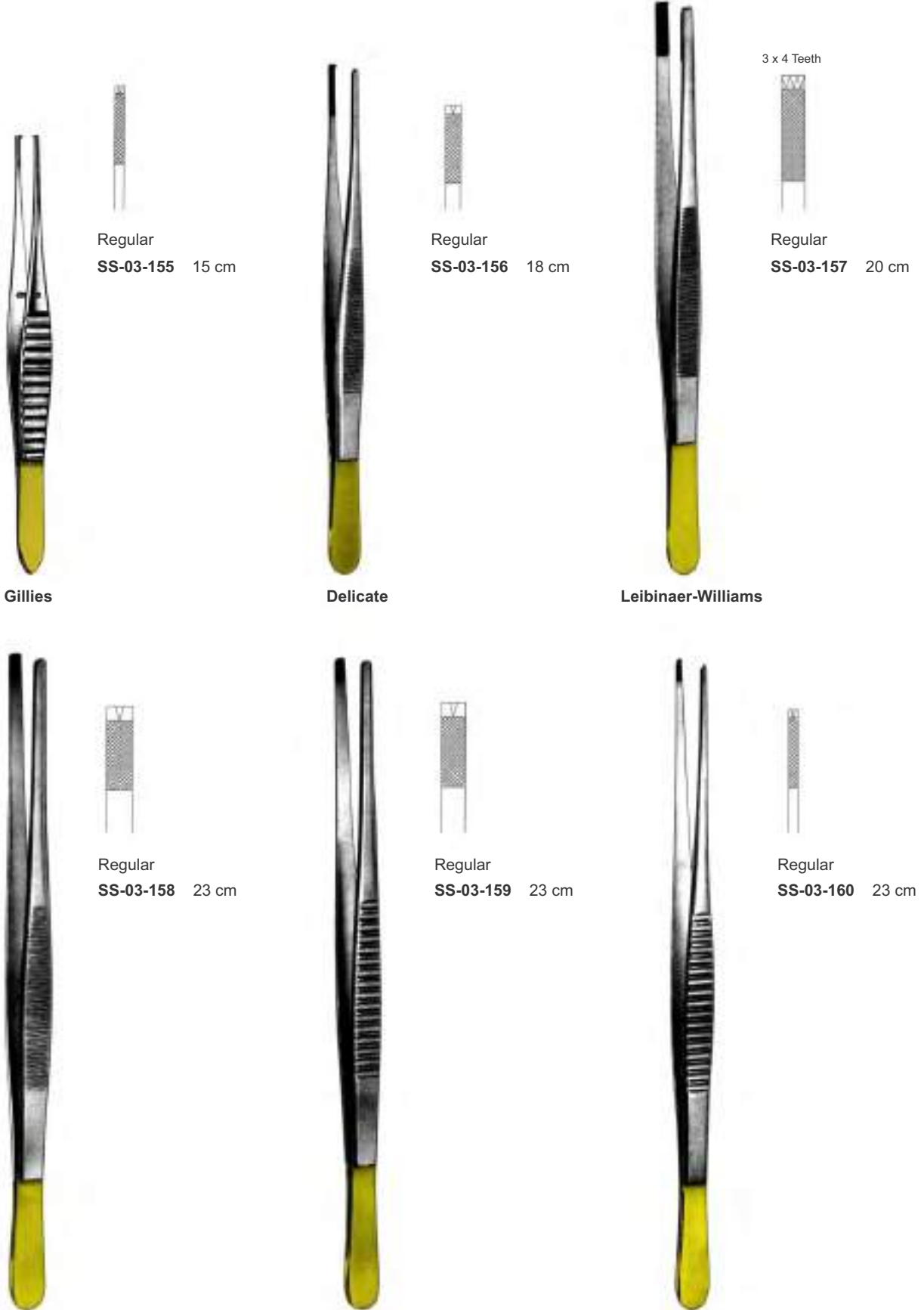



SAPTESTAR
Manufacturer & Exporter Of Surgical, Dental & Veterinary Instruments

Tissue Forceps with tungsten carbide edges
Pinzas quirurgicas con filos de carbure tungsteno
Pinces a dissection a griffes avec des lames en tungstene



Coarse
SS-03-161 14.5 cm

Standard



Coarse
SS-03-162 16 cm

Standard



Coarse
SS-03-163 18 cm

Standard



Coarse
SS-03-164 17 cm

Baker Mod. (Bonney)











Coarse
SS-03-165 17 cm

Ferries-Smith

Tissue Forceps with tungsten carbide edges
Pinzas quirurgicas con filos de carbure tungsteno
Pinces a dissection a griffes avce des lames en tungstene

DEBAKEY-LEIBINGER Tissue Forceps with atraumatic serrations at the distal tip and finely cut Tungsten Carbide inserts placed directly behind.
The serration pattern cut in to the tips will grasp delicate tissues firmly yet with minimal trauma. The additional Tungsten Carbide insert allow the use of these forceps for controlled needle "pulling" as the needle is drawn through the tissue. Particularly use full for delicate vascular and cardiac surgery.

Atraumatic Serrations

1.5 mm	2.0 mm	2.7 mm	3.5 mm
			
Fine	Fine	Fine	Fine
BC-03-166 15 cm SS-03-167 19.5 cm SS-03-168 24 cm	BC-03-169 15 cm SS-03-170 19.5 cm SS-03-171 24 cm	BC-03-172 15 cm SS-03-173 19.5 cm SS-03-174 24 cm	BC-03-175 19.5 cm SS-03-176 24 cm
			
Leibinger-DeBakey	Leibinger-DeBakey	Leibinger-DeBakey	Leibinger-DeBakey



SAPTESTAR
Manufacturer & Exporter Of Surgical, Dental & Veterinary Instruments

Tissue Forceps with tungsten carbide edges
Pinzas quirurgicas con filos de carbure tungsteno
Pinces a dissection a griffes avce des lames en tungstene

Atraumatic Serrations
Handles are shapes to allow comfortable finger placement.

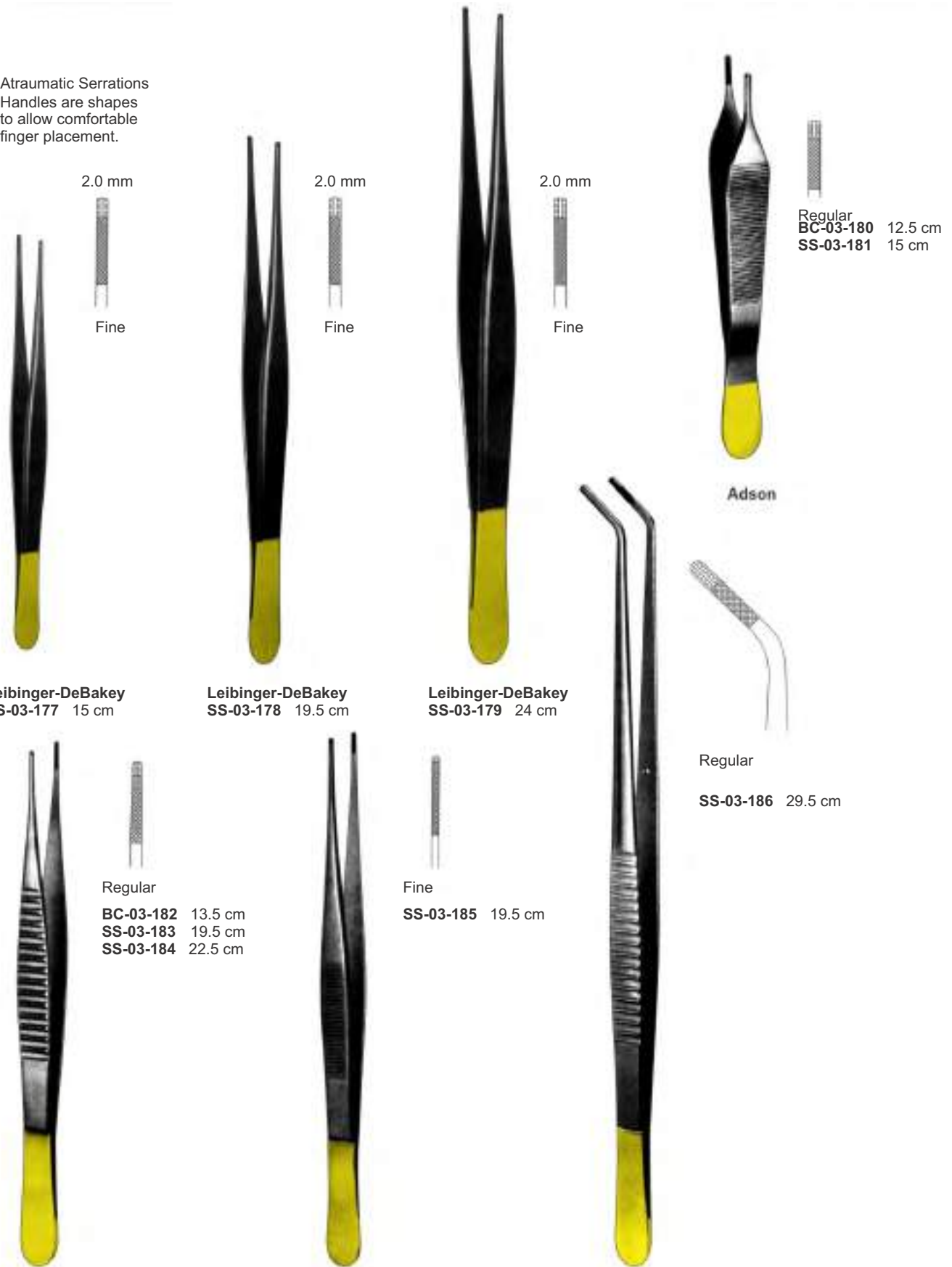

2.0 mm

Fine

Leibinger-DeBaakey
SS-03-177 15 cm

2.0 mm

Fine

Leibinger-DeBaakey
SS-03-178 19.5 cm

2.0 mm

Fine

Leibinger-DeBaakey
SS-03-179 24 cm

Regular
BC-03-180 12.5 cm
SS-03-181 15 cm

Adson



Regular

SS-03-186 29.5 cm

Regular

BC-03-182 13.5 cm
SS-03-183 19.5 cm
SS-03-184 22.5 cm

Fine

SS-03-185 19.5 cm



**TC
Needle Holders
04**

04 TC Needle Holders

Arruga	14	Micro-Vascular	12, 22
Baby Crile-Wood	03	Mini-Ryder	25
Berry	31	Mobley-Webster	24
Boynton	14	Muller	17
Bozeman (wertheim)	18	Neivert	04
Bozeman-Finochietto	18	New Orleans	05
Bozemann	11	Olsen-Hegar	13, 24
Castroviejo	28, 29	Olsen-Webster	24
Cooley-Style	21	Original Debakey	08
Costatini	21	Par-Style	02
Crile-Wood Modif.	04	Pechlaner	34
Crile-Wood	03-05	Pin Puller	34
Debakey Delicate	21	Pittmann	06
Debakey	10, 21	Rein	17
Dert	02	Rochester	22
Diethrich	25	Ryder	09
Double-Action	29	Ryder-Vascular	10
Eufrate-Pasque	27	Sarot	05, 21
Finochietto	06	Schacke	29
Flat Nose Plier	34	Smith	35
Foster-Gillies	13	Stratte Delicate	07
French Eye Delicate	26	Stratte Reverse	19
French Eye	26	Stratte	07, 19
Front & Lateral Cutter	37-39	Tessier	29
Gillies-Webster	13	Thorlakson	07
Halsey	02	Toennis Delicate	15
Heaney	05	Toennis	15
Hegar	12	Turner-Warwick	20
Hegar-Baumgartner	04	Universal Crile-Wood	23
Hegar-Vascular	11	Universal Debakey	23
Heger	32	Universal Halsey	23
Hellberg	17	Universal Mayo-Hegar	23
Hoesel	16	Universal	35
Hufnagel-Ryder	25	Wangensteen	11
Intracardiac	25	Webster	02
Julian-Style	21	Wire Cutters	36
Kalt	29	Wire Holding Forceps	30, 33
Kilner	02, 18	Wire Twisting Forceps	67, 68
Kirschner Wires Cutter	39		
Korkhaus	32		
Kremer	32		
Langenbeck	15		
Langenbeck-Ryder	15		
Leibinger	32		
Leibinger-Castroviejo	28		
Leibinger-Marberger	29		
Lemmon	22		
Lindorf	62		
Martin	06		
Martini	12		
Masson	09		
Masson-Luethy	18		
Mathieu	14, 16		
Mathieu-Eiselsbeg	16		
Mathieu-Kocher	14		
Mathieu-Ryder	14		
Mathieu-Style	31		
Mayo-Hegar	09		

Needle Holders with tungsten carbide edges
Porta-agujas con filos de carbure tungsteno
Porte-aiguilles avec des lames en tungstene

- Wide selection of patterns for all facets of surgery with many WELMED INSTRUMENTS exclusive specialties
- five different Tungsten Carbide insert styles for needle and suture sizes up to 10-0.
- Precisely machined and handcrafted for longlasting performance
- gold-plated ring-handles for easy identification



Serrations: 0.5 mm - REGULAR

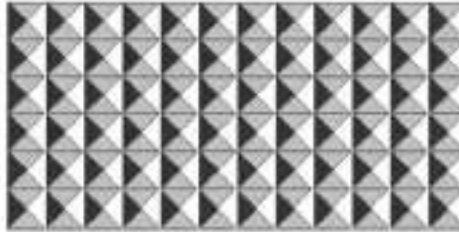

REGULAR

This tooth size is ideal for use in standard pattern needle holders like Mayo-Hegar, Mathieu, Bozeman a.o. And in needle-pulling tissue forceps. For holding large needles with sutures sized 3-0 and larger.

Serrations: 0.4 mm - FINE

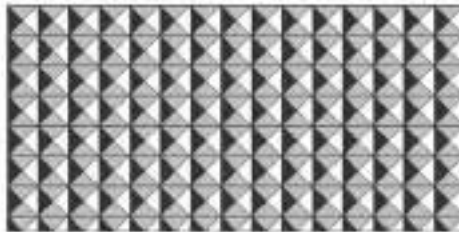

FINE

Best for use in needle holders such as Crile-Wood, DeBakey, Ryder, a.o. And in delicate needlepulling tissue forceps. For holding needles and sutures between 4-0 and 6-0.

Serrations: 0.65 mm - COARSE

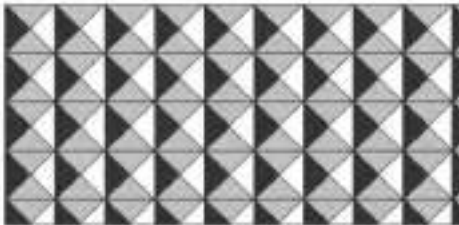

COARSE

This coarsely serrated insert is placed in the most powerful needle holder patterns and wire twisters and assures maximum holding ability when using heavy needles or surgical wire.

Serrations: 0.2 mm - MICRO

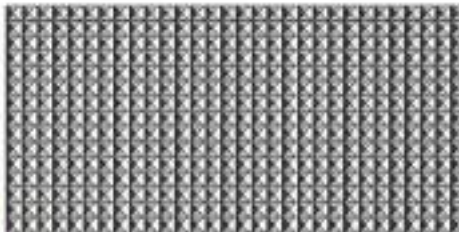

MICRO

This micro size is extremely effective for use in microsurgical needle holders like Castroviejo, Mini-Ryder, Microvascular, Lemmon and other microoriented needle holders. For use with the most delicate needles and sutures from size 7-0 to 10-0. Excellent delicate needle holding ability without minimal damage to needle or suture.



SMOOTH

The smooth insert is designed to hold the smaller suture sizes without damage to the suture or needle. Its needleholding ability is somewhat limited, however. Used primarily in needle holders for plastic surgery and microsurgery.



SAPTESTAR
Manufacturer & Exporter Of Surgical, Dental & Veterinary Instruments

Needle Holders with tungsten carbide edhes
Porta-agujas con filos de carbure tungsteno
Porte-aiguilles avce des lames en tungstene



Micro

SS-04-101 11.5 cm
SS-04-102 12.5 cm

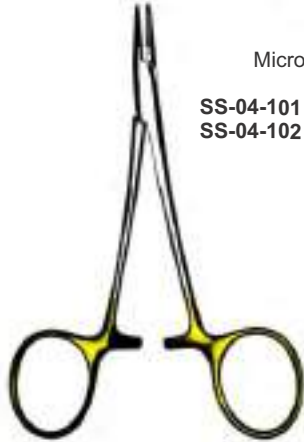

Par-style



Fig. 1
Serrated



Fig. 2
Smooth

SS-04-103
1.2 cm



Webster



BC-04-104
1.3 cm
Serrated
Mini profile
perfil mini
perfil mini



Kilner



Fine
SS-04-105
12 cm



Derf



Smooth
BC-04-106
13 cm

Smooth jaw
boca lisa
mors lisse

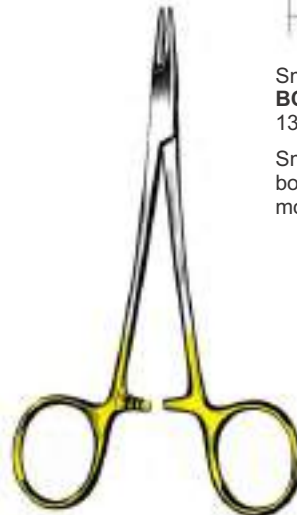

Halsey



Serrated
BC-04-107
13 cm

Mini profile
perfil mini
perfil mini

Needle Holders with tungsten carbide edges
 Porta-agujas con filos de carbure tungsteno
 Porte-aiguilles avec des lames en tungstene



Crile-wood



Sarot
Crile-Wood

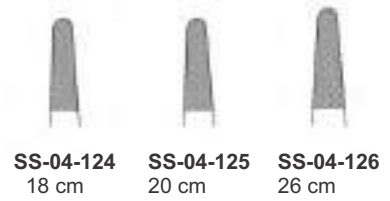

Heaney

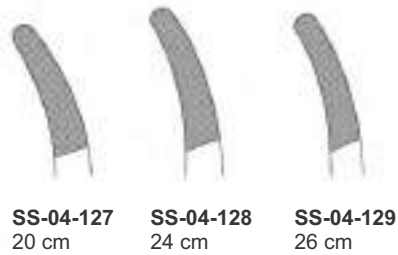

New Orleans





SAPTESTAR
Manufacturer & Exporter Of Surgical, Dental & Veterinary Instruments

Needle Holders with tungsten carbide edges
Porta-agujas con filos de carbure tungsteno
Porte-aiguilles avec des lames en tungstene



Martin

SS-04-131 15 cm



SS-04-132 17 cm



SS-04-133 20 cm

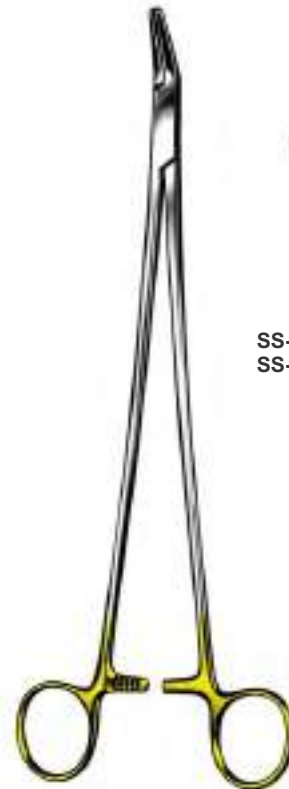

Finochietto

SS-04-134 21 cm
SS-04-135 26 cm



Regular



Pittmann



Regular

SS-04-136 18-5 cm



Regular

SS-04-137 20-5 cm



Regular

SS-04-138 24 cm
SS-04-139 26 cm
SS-04-140 30 cm

Upward Curved jaw configuration allows exceptional torque or driving force to be generated. Needle remains in upward position when needle holder shanks are at 45° angle.

Needle Holders with tungsten carbide edges
Porta-agujas con filos de carbure tungsteno
Porte-aiguilles avec des lames en tungstene



Stratte



SS-04-141
23 cm



SS-04-142
23 cm



Stratte Delicate

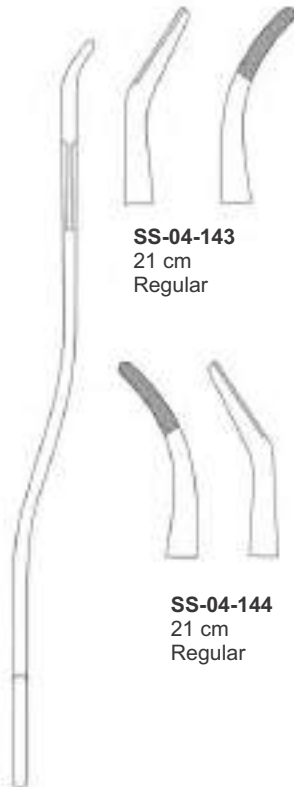

SS-04-143
21 cm
Regular

SS-04-144
21 cm
Regular



BC-04-145 20 cm
SS-04-146 25 cm
SS-04-147 28 cm
Regular



SAPTESTAR
Manufacturer & Exporter Of Surgical, Dental & Veterinary Instruments

Needle Holders with tungsten carbide edges
Porta-agujas con filos de carburo tungsteno
Porte-aiguilles avec des lames en tungstene



Regular

SS-04-148 19.5 cm
SS-04-149 21.5 cm
SS-04-150 24.5 cm

Regular pattern



Fine

SS-04-151 16.5 cm
Delicate pattern



Fine

SS-04-152 19.5 cm
SS-04-153 24.5 cm

Delicate pattern

With black oxidized ring handles
for identification as "Original DeBakey"

Needle Holders with tungsten carbide edges
Porta-agujas con filos de carbure tungsteno
Porte-aiguilles avec des lames en tungstene



Mayo-Hegar

SS-04-154
16 cm

SS-04-155
18 cm

SS-04-156
20 cm

SS-04-157
24 cm

SS-04-158
26 cm

SS-04-159
30 cm

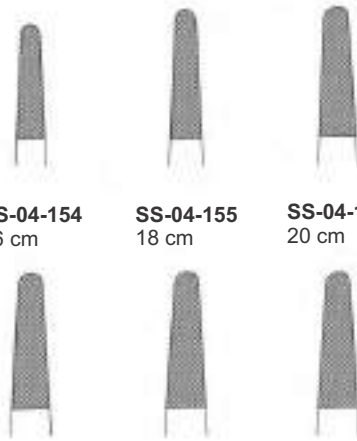

Ryder

SS-04-161
12-5 cm

SS-04-162
15 cm

SS-04-163
18 cm

SS-04-164
20 cm

SS-04-165
23 cm

SS-04-166
26 cm

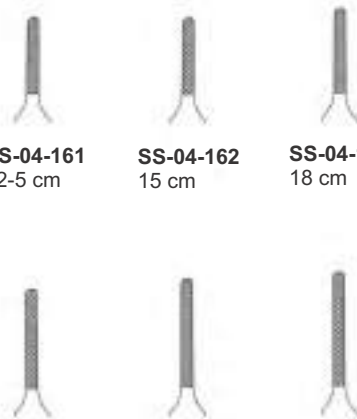

Masson

SS-04-160
26-5 cm





SAPTESTAR
Manufacturer & Exporter Of Surgical, Dental & Veterinary Instruments

Needle Holders with tungsten carbide edges
Porta-agujas con filos de carbure tungsteno
Porte-aiguilles avec des lames en tungstene



Debakey



SS-04-167
18 cm



SS-04-168
20 cm



SS-04-169
23 cm



SS-04-170
26 cm



SS-04-171
31 cm



Ryder-Vascular



SS-04-172
12-5 cm



SS-04-173
15-5 cm



SS-04-174
17-5 cm



SS-04-175
20-5 cm



SS-04-176
22-5 cm



SS-04-177
26-5 cm

Needle Holders with tungsten carbide edges
 Porta-agujas con filos de carbure tungsteno
 Porte-aiguilles avec des lames en tungstene



Bozemann

SS-04-178
20-5 cm

SS-04-179
24 cm

SS-04-180
26-5 cm

SS-04-181
29 cm

SS-04-182
27 cm



Heagar-Vascular

SS-04-183
14 cm

SS-04-184
18-5 cm

SS-04-185
20-5 cm

SS-04-186
23 cm



Wangenstein



SAPTESTAR
Manufacturer & Exporter Of Surgical, Dental & Veterinary Instruments

Needle Holders with tungsten carbide edges
Porta-agujas con filos de carbure tungsteno
Porte-aiguilles avec des lames en tungstene



Martini



SS-04-187
14 cm



SS-04-188
16 cm



SS-04-189
17-5 cm



SS-04-190
20 cm



SS-04-191
14 cm



SS-04-192
16 cm



SS-04-193
17-5 cm



SS-04-194
20 cm



Micro-Vascular



SS-04-195
14 cm



SS-04-196
17-5 cm



SS-04-197
20 cm



SS-04-198
23 cm



Hegar



SS-04-199
20 cm



SS-04-200
23-5 cm

Needle Holders with tungsten carbide edges
 Porta-agujas con filos de carbure tungsteno
 Porte-aiguilles avec des lames en tungstene



Fine
SS-04-201 14.5 cm

Olsen-hegar



Fine
SS-04-202 17 cm



Regular
SS-04-203 18.5 cm

Olsen-hegar



Smooth
SS-04-204 14.5 cm



Smooth
SS-04-205 17 cm

Olsen-hegar



SS-04-206
 14.5 cm



SS-04-207
 17 cm



SS-04-208
 19 cm



Smooth
SS-04-209 10.5 cm

Foster-Gillies



Fine
SS-04-210
 16 cm



Smooth
SS-04-211
 16 cm

Gillies- Webster



SAPTESTAR
Manufacturer & Exporter Of Surgical, Dental & Veterinary Instruments

Needle Holders with tungsten carbide edges
Porta-agujas con filos de carbure tungsteno
Porte-aiguilles avec des lames en tungstene



Fine

SS-04-212 12 cm



Boynton



Fine

SS-04-213 16.5 cm



Arruga



Fine

SS-04-214 16.5 cm



Arruga



14 cm
SS-04-215
Regular



Mathieu



17.5 cm
SS-04-216



20 cm
SS-04-217



Mathieu-Kocher



14 cm
SS-04-218
Regular



17.5 cm
SS-04-219



20 cm
SS-04-220



Mathieu-Ryder



17.5 cm
SS-04-221
Fine



20 cm
SS-04-222

Needle Holders with tungsten carbide edges
 Porta-agujas con filos de carbure tungsteno
 Porta-aiguilles avec des lames en tungstene



Fine
SS-04-223 18 cm

Toennis Delicate

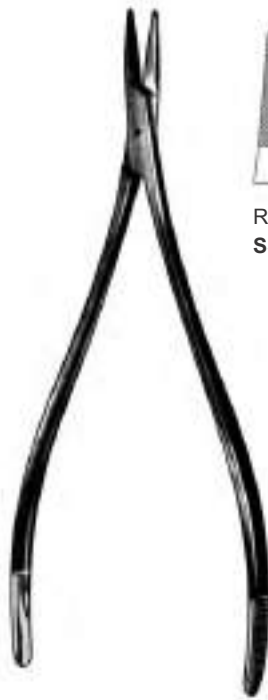

Regular
SS-04-224 18 cm

Toennis Delicate



Regular
SS-04-225 18 cm

Toennis



Regular
SS-04-226 20 cm

Toennis

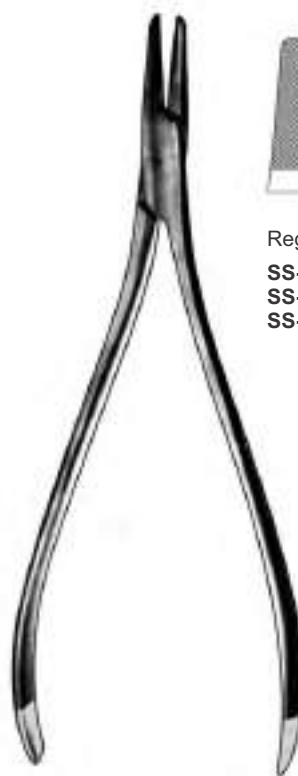

Regular
SS-04-227 16 cm
SS-04-228 18 cm
SS-04-229 20 cm

Langenbeck



Fine
SS-04-230 20 cm

Langenbeck-Ryder



SAPTESTAR
Manufacturer & Exporter Of Surgical, Dental & Veterinary Instruments

Needle Holders with tungsten carbide edges
Porta-agujas con filos de carbure tungsteno
Porta-aiguilles avec des lames en tungstene

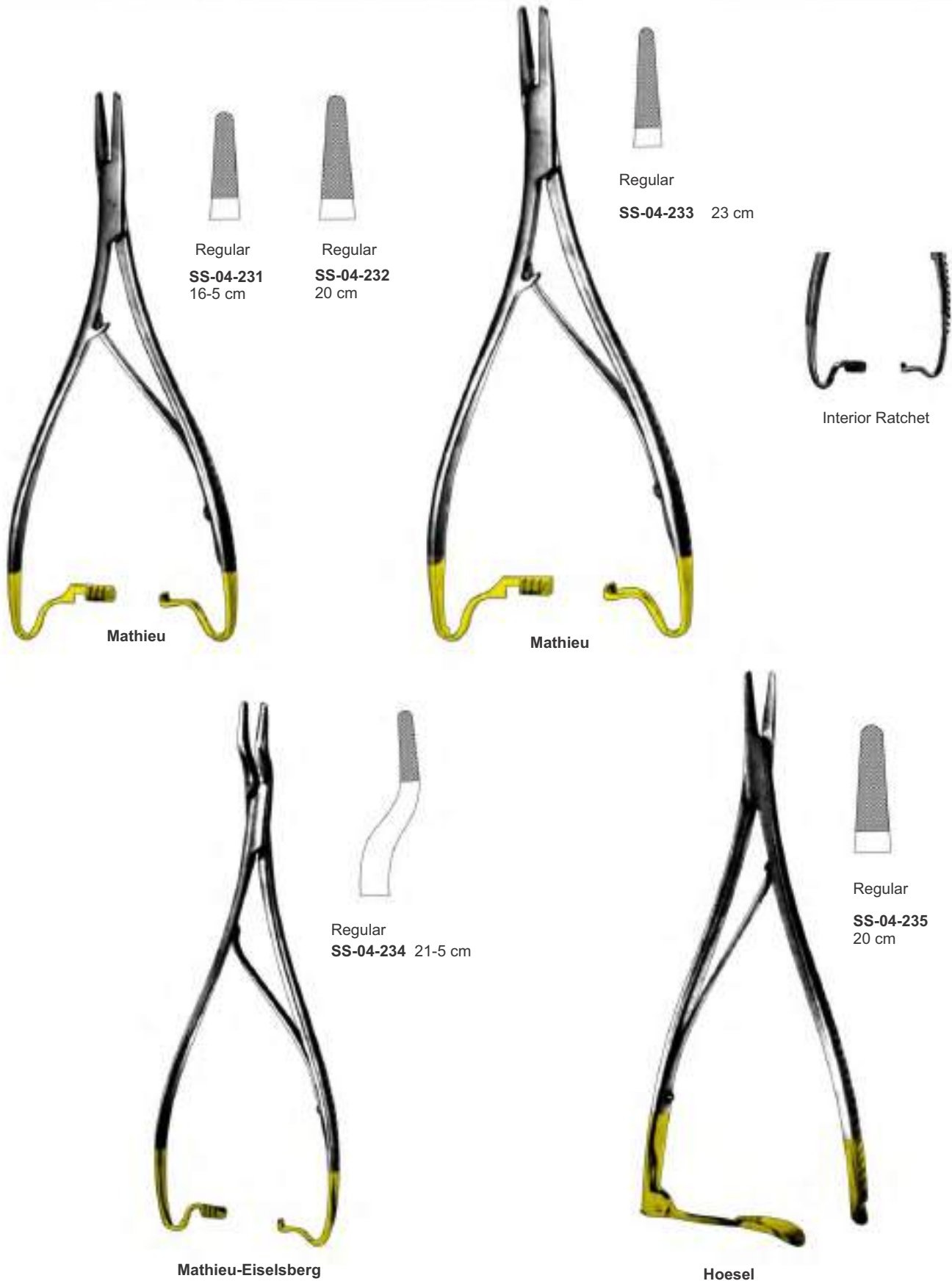

Needle Holders with tungsten carbide edges
 Porta-agujas con filos de carbure tungsteno
 Porta-aiguilles avec des lames en tungstene



0.2
SS-04-236
 210 mm, 8¼"

HELLBERG / KUPKA



0.2
BC-04-237
 90 mm, 7½"

REIN / KUPKA



0.2
SS-04-238
 Needle holder with catch
 190 mm 7½"

REIN / KUPKA



0.4
MÜLLER
SS-04-239
 Ergonomic handle
 175 mm, 7"

These instruments provide the surgeon with a maximum of ergonomical comfort. The optimized design of the Instruments offers a fatigue-free working especially-with regard to difficult suture and anastomosis techniques.



SAPTESTAR
 Manufacturer & Exporter Of Surgical, Dental & Veterinary Instruments

Needle Holders with tungsten carbide edges
 Porta-agujas con filos de carbure tungsteno
 Porta-aiguilles avec des lames en tungstene



Fine
SS-04-240 14.5 cm

Kilner



Regular
SS-04-241 20.5 cm

Regular
BC-04-242 24 cm
SS-04-243 26 cm

Bozeman(Wertheim)



Regular

SS-04-244
 20.5 cm

Regular

SS-04-245
 26.5 cm

Messer Luehry



Regular

SS-04-246 20.5 cm
SS-04-247 26 cm

Bozeman Finocchio

Needle Holders with tungsten carbide edges
 Porta-agujas con filos de carbure tungsteno
 Porta-aiguilles avec des lames en tungstene

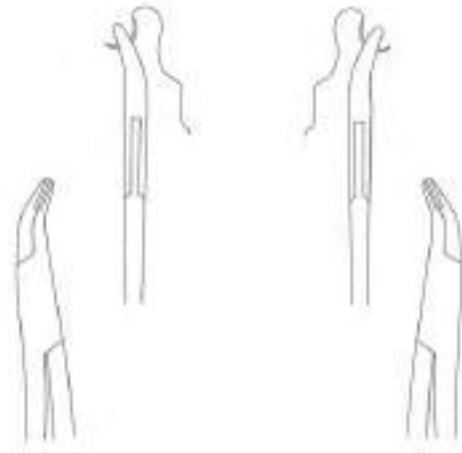

The corkscrew design of the jaws permits easier suturing when operating field is restricted or difficult of access.

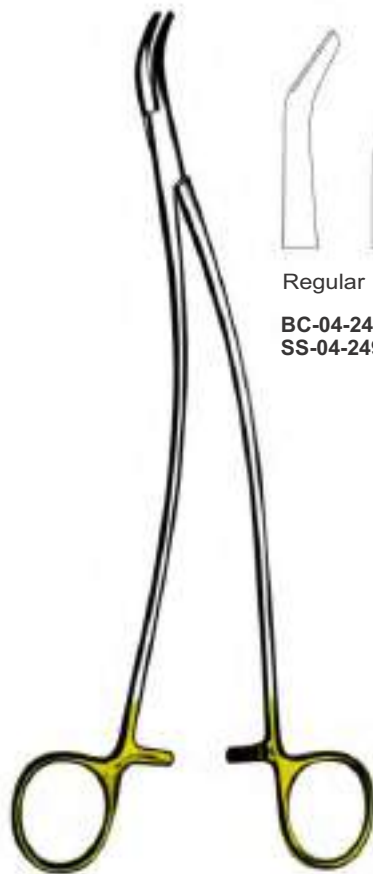

Stratte



Regular

BC-04-248 21 cm
SS-04-249 23 cm



Regular

BC-04-250 21 cm
SS-04-251 23 cm

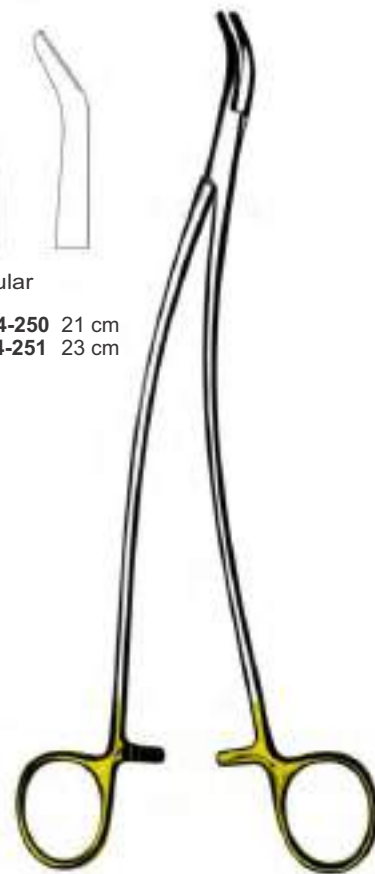

Stratte Reverse



SAPTESTAR
Manufacturer & Exporter Of Surgical, Dental & Veterinary Instruments

Needle Holders with tungsten carbide edges
Porta-agujas con filos de carbure tungsteno
Porta-aiguilles avce des lames en tungstene



For right-handers
Left hand patterns available on request..

Instrument set



Needle Holders with tungsten carbide edges
 Porta-agujas con filos de carbure tungsteno
 Porta-aiguilles avec des lames en tungstene

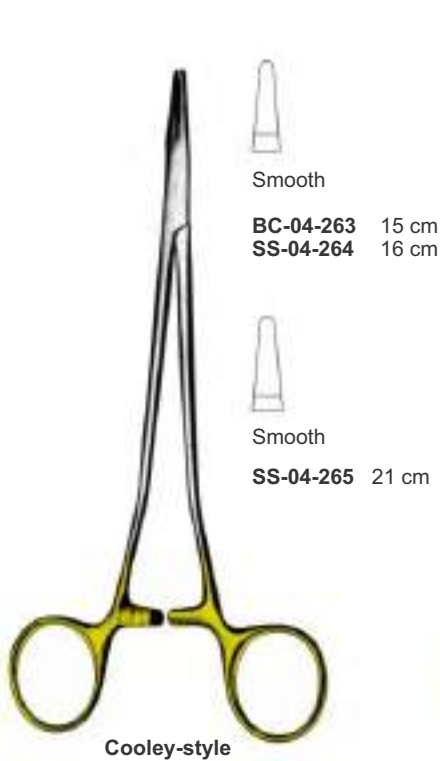
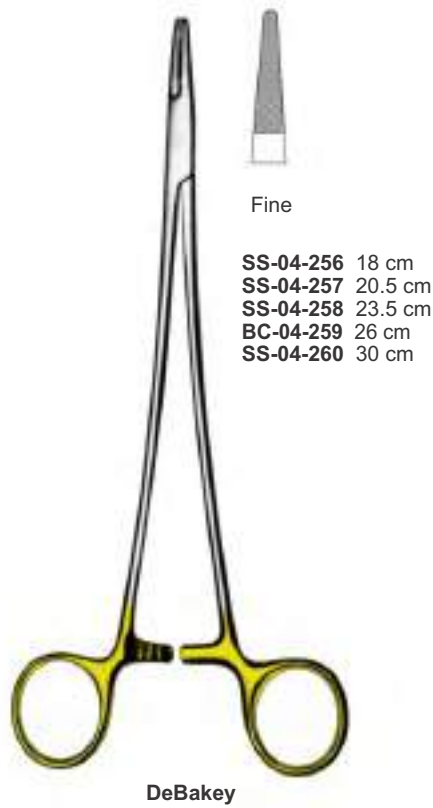
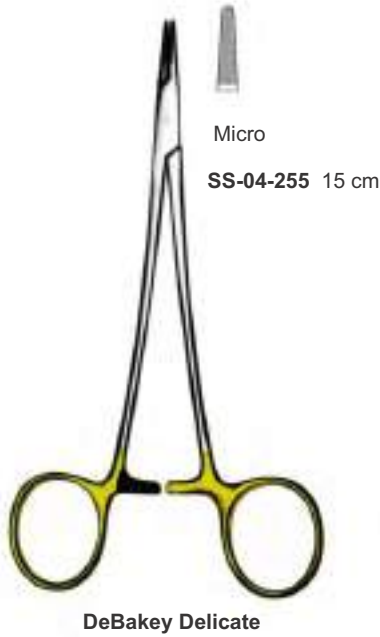



SAPTESTAR
Manufacturer & Exporter Of Surgical, Dental & Veterinary Instruments

Needle Holders with tungsten carbide edges
Porta-agujas con filos de carbure tungsteno
Porta-aiguilles avec des lames en tungstene

The LEMMON Needleholder was designed for vascular surgery. Tips tapered to the point.



Lemmon



Micro

BC-04-269 14.5 cm
SS-04-270 17 cm
SS-04-271 19.5 cm



Microvascular



Micro

SS-04-272 14 cm



Fine

SS-04-273 18.5 cm



Micro

BC-04-274 18 cm
SS-04-275 20.5 cm
SS-04-276 23 cm

Microvascular

Needle Holders with tungsten carbide edges
 Porta-agujas con filos de carbure tungsteno
 Porta-aiguilles avec des lames en tungstene

UNIVERSAL

A selected range of needle holders with unique ratchet design. Can be used by both, right-handed and left-handed surgeons.



Fine

SS-04-277
13.5 cm

Universal Halsey



Fine

SS-04-278
15 cm

Fine

SS-04-279 18 cm
SS-04-280 20.5 cm

Universal Crile-Wood



Regular

SS-04-281 16 cm



Regular

SS-04-282 19 cm
SS-04-283 20.5 cm

Universal Mayo-Hegar



Fine

SS-04-284 20.5 cm

Universal DeBakey



SAPTESTAR
Manufacturer & Exporter Of Surgical, Dental & Veterinary Instruments

Needle Holders with tungsten carbide edges
Porta-agujas con filos de carbure tungsteno
Porta-aiguilles avec des lames en tungstene



Fine
SS-04-285 11.5 cm

Olsen-Hegar



Fine
SS-04-286 11.5 cm

Mobley-Webster



Smooth
SS-04-287 11.5 cm

Mobley-Webster



Smooth
SS-04-288 11.5 cm

Olson-Webster



Fine
SS-04-289 14.5 cm

Mobley-Webster



Smooth
SS-04-290 14.5 cm

Mobley-Webster

Needle Holders with tungsten carbide edges
 Porta-agujas con filos de carbure tungsteno
 Porta-aiguilles avce des lames en tungstene

MINI-RYDER Needleholders with new special Micro Tungstan Carbide to hold needles and sutures up to 10 x 0. A well-balanced needleholder for delicate surgical procedures.



Micro

BC-04-291 12 cm
SS-04-292 15 cm

Mini-Ryder



Micro

SS-04-293 18 cm
SS-04-294 20 cm
SS-04-295 23 cm

Mini-Ryder



Micro

BC-04-296 16 cm
SS-04-297 18 cm
SS-04-298 20 cm
SS-04-299 23 cm

Diethrich

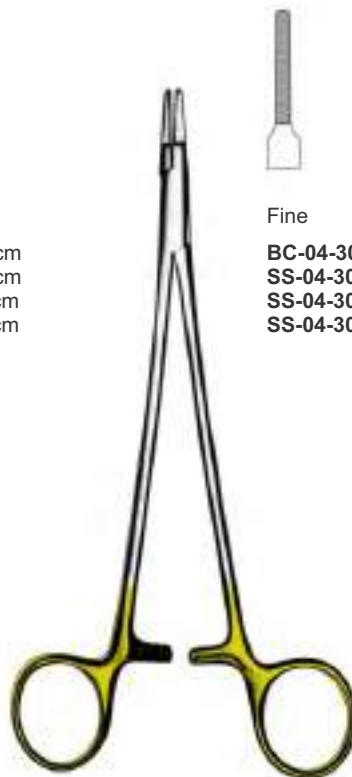

Fine

BC-04-300 18 cm
SS-04-301 20.5 cm
SS-04-302 23 cm
SS-04-303 26.5 cm

Intracardiac



Fine

SS-04-304 22.5 cm

Hufnagel-Ryder



SAPTESTAR
Manufacturer & Exporter Of Surgical, Dental & Veterinary Instruments

Needle Holders with tungsten carbide edges
Porta-agujas con filos de carbure tungsteno
Porta-aiguilles avec des lames en tungstene



Fine

SS-04-305 13 cm
SS-04-306 15 cm

French Eye Delicate



Smooth

BC-04-307 13 cm
SS-04-308 15 cm

French Eye Delicate

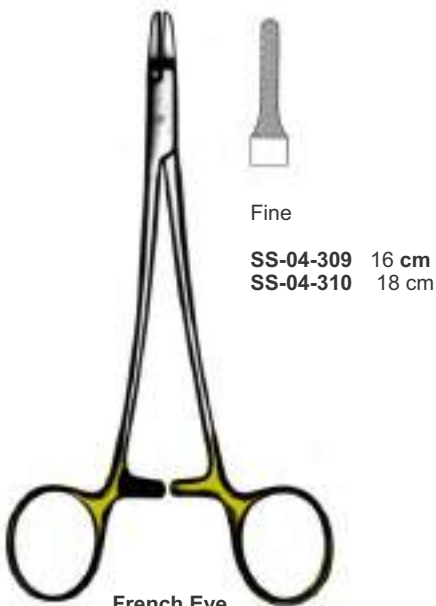

Fine

SS-04-309 16 cm
SS-04-310 18 cm

French Eye



Fine

BC-04-311 20.5 cm
SS-04-312 23.5 cm
SS-04-313 26 cm

French Eye

Needle Holders with tungsten carbide edges
 Porta-agujas con filos de carbure tungsteno
 Porta-aiguilles avec des lames en tungstene

EUFRATE PASQUE Needle-holders to hold needles and sutures up to 10 x 0. Specially designed for intra-cardiac and delicate urological surgery in neonates..



Eufrate-Pasqué



Micro

BC-04-314 14 cm
SS-04-315 15 cm



Eufrate-Pasqué



Smooth

BC-04-316 14 cm
SS-04-317 15 cm



Eufrate-Pasqué



Micro

BC-04-318 18 cm
SS-04-319 20 cm



Eufrate-Pasqué













Smooth

BC-04-320 18 cm
SS-04-321 20 cm



SAPTESTAR
Manufacturer & Exporter Of Surgical, Dental & Veterinary Instruments

Needle Holders With tungsten carbide edges
Porta-agujas con filos de carbure tungsteno
Porta-aiguilles avec des lames en tungstene

	<p>Micro</p>  <p>14 cm WI-04-322</p>  <p>WI-04-323 14 cm WI-04-324 18 cm</p>		<p>Micro</p>  <p>14 cm WI-04-325</p>  <p>14 cm WI-04-326</p>		<p>Micro</p>  <p>WI-04-327 18 cm WI-04-328 22 cm</p>  <p>WI-04-329 22 cm</p>
<p>Castroviejo</p>		<p>Castroviejo</p>		<p>Castroviejo</p>	
	 <p>14 cm WI-04-330</p>  <p>14 cm WI-04-331</p> <p>Smooth</p>		 <p>Smooth</p> <p>WI-04-332 18 cm WI-04-333 22 cm</p>		 <p>Regular</p> <p>WI-04-334 18.5 cm</p>
<p>Castroviejo</p>		<p>Castroviejo</p>		<p>Leibinger-castroviejo</p>	

Needle Holders with tungsten carbide edges
Porta-agujas con filos de carbure tungsteno
Porta-aiguilles avec des lames en tungstene

Micro Needle Holders

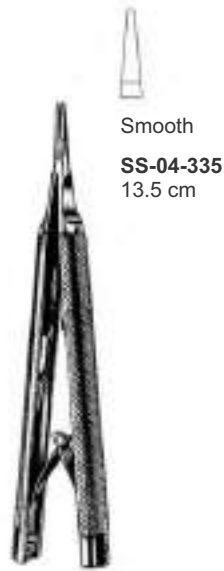

Castroviejo



Kalt

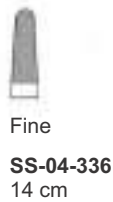

Tessier



Double-Action

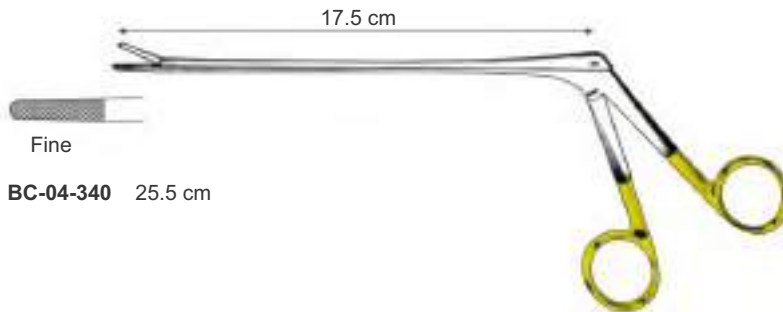

Schacke



An IUD in place but no visible thread...?
Here is your help:
The shaft of the IUD removal forceps has the same diameter as the cervical canal. It can be used without dilation and without anaesthesia. Its jaws with finely serrated TC-inserts get a firm grip of the IUD (. . . Or its thread) for safe and simple removal.



SAPTESTAR
Manufacturer & Exporter Of Surgical, Dental & Veterinary Instruments

Wirt Twisting Forceps with tungsten carbide edges
Pinzas cierra-hilos con filos de carbure tungsteno
Pinces serre- fils avec des lames en tungstene



SS-04-342
15 cm / 6"



SS-04-343
15 cm / 6"



SS-04-344
18 cm / 7"



SS-04-345
18.5 cm / 7 1/4"



LINDORF
SS-04-346
20 cm / 8"

Wirt Twisting Forceps with tungsten carbide edges
 Pinzas cierra-hilos con filos de carbure tungsteno
 Pincas serre- fils avec des lames en tungstene

These powerful broad jaw patterns have Tungsten Carbide inserts which hold the wirt Securely under the strain of the entire wire twisting process. They serve as sternal needle holders as well thus providing heavy sternal needles.



Coarse
SS-04-347 18.5 cm

Berry



Coarse
SS-04-348 17.5 cm

Mathieu-Style



Coarse
SS-04-349 20 cm

Mathieu-Style



SAPTESTAR
Manufacturer & Exporter Of Surgical, Dental & Veterinary Instruments

Wirt Twisting Forceps with tungsten carbide edges
Pinzas cierra-hilos con filos de carbure tungsteno
Pinces serre- fils avec des lames en tungstene



Regular
SS-04-350 13 cm



Leibinger



Regular
SS-04-351 15 cm



Regular
SS-04-352 18 cm



Regular
BC-04-353 15 cm
SS-04-354 18 cm



Hegar



Regular
SS-04-355 17.5 cm



Kremer



Regular
SS-04-356 15.5 cm



Korkhaus
Wire Ligature Forceps

Wirt Twisting Forceps with tungsten carbide edges
Pinzas cierra-hilos con filos de carbure tungsteno
Pincas serre- fils avec des lames en tungstene



2 mm



SS-04-357-1
18 cm / 7"

4 mm



SS-04-357-2
18 cm / 7"

6mm



SS-04-357-3
18 cm / 7"



SS-04-2005
17 cm / 6¾"



SS-04-2006
20 cm / 8"

Mathieu-Hauberisier

Wirt Holding Forceps
Pinzas para extraer alambres
Pincas tire-broches

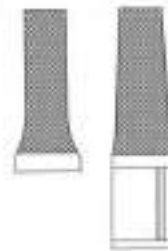
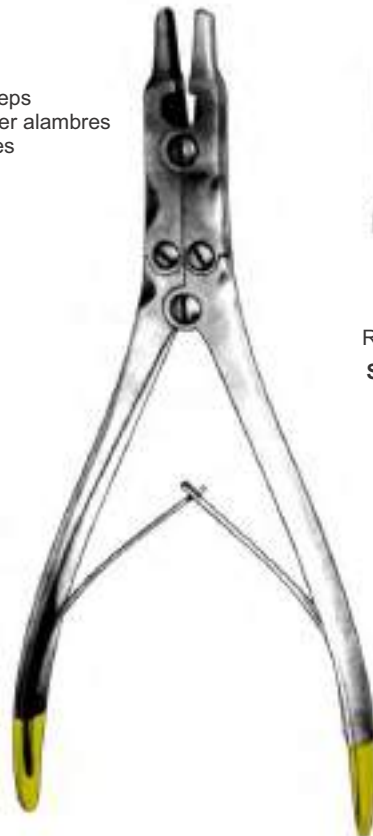

Regular
SS-04-358 22 cm / 8"



SAPTESTAR
Manufacturer & Exporter Of Surgical, Dental & Veterinary Instruments

Wirt Holding Forceps With tungsten carbide edges
Pinzas Para extraer alambres con filos de carbure tungsteno
Pinces tire-broches avce des lames en tungstene

Lower jaw



Pin Puller

Upper jaw



Coarse
SS-04-359 13.5 cm



Coarse
SS-04-360 14.5 cm



Flat Nose Plier



Coarse
SS-04-361 13.5 cm



Flat Nose Plier

Double-action Wire Pulling and Bending Pliers with Tungsten Carbide inserts. A reliable instrument for wire-bending and extraction of K-wires, pins etc. Ensures secure grasping and holding, reduces hand-fatigue.



Coarse
SS-04-362 18 cm

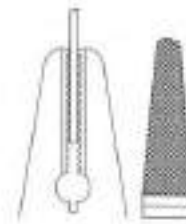

Coarse
SS-04-363 18 cm

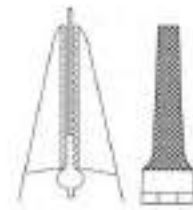

Coarse
SS-04-364 18 cm

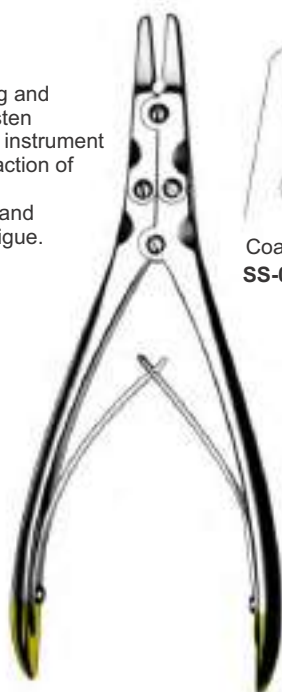

Pechlaner

Wire Cutters With tungsten carbide edges
Alicates Corta alambres con filos de carbure tungsteno
Pinces a couper le fill avec des lames en tungstene

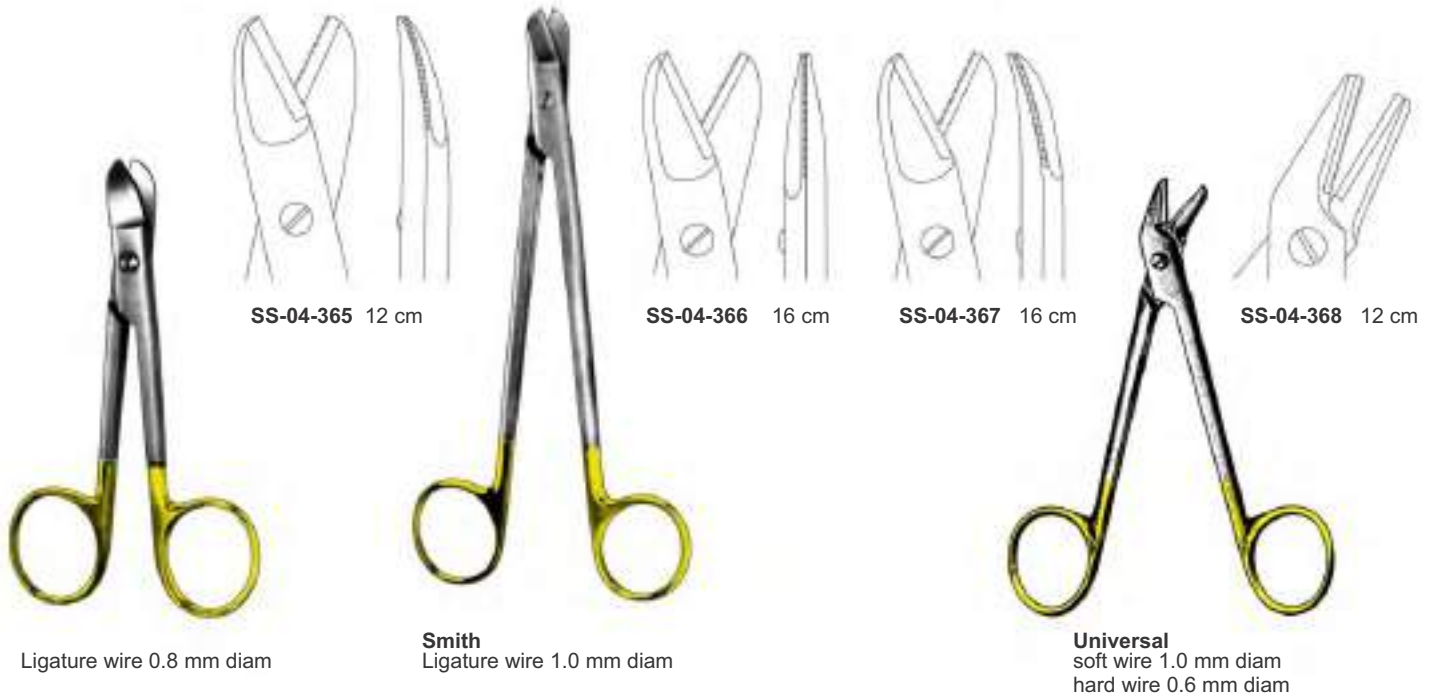



SAPTESTAR
Manufacturer & Exporter Of Surgical, Dental & Veterinary Instruments

Wirt Cutters With tungsten carbide edges
Alicates Corta alambres con filos de carbure tungsteno
Pinces a couper le fill avec des lames en tungstene



SS-04-371
12.5 cm / 5"



For hard wire
0.6 mm diam
For soft wire
1.0 mm diam



SS-04-372
18.5 cm / 7 1/4"



For soft wire
2.0 mm diam
For hard wire
1.7 mm diam



SS-04.373



1.6 mm For
hard wire
2.6 mm For
soft wire



SS-04.374



For soft wire
2.8 mm diam
For hard wire
2.2 mm diam

Front & Lateral Cutters With tungsten carbide edges
 Alicates de corte frontal Y lateral con filos de carbure tungsteno
 Pincas a couper le fill avce des lames en tungstene



SS-04-376
 23.5 cm / 9¼"
 Wire Cutter whit
 Tungsten carbide Edges



Soft Wire 3 mm
 Hard Wire 2.7 mm



SS-04-377 48 cm /18¾"
SS-04-378 54 cm /21¼"
 Cutters for cutting of wires, screws and
 pins up to diam. 6 mm

Alicates corta-alambres, tornillos y
 clavos hasta Ø 6 mm

Pincas á couper les fils, pivots et clous
 jusqu, á 6 mm Ø



SAPTESTAR
Manufacturer & Exporter Of Surgical, Dental & Veterinary Instruments

Front & Lateral Cutters With tungsten carbide edges
Alicates de corte frontal Y lateral con filos de carbure tungsteno
Pincas a couper le fill avec des lames en tungstene



Soft Wire 0,9 mm
Hard Wire 0,9 mm
Specially hardened cutting edges
SS-04-379
Angled slender pattern for wire removal after sternum suture.
170 mm / 6¾"
For hard wire up to diam

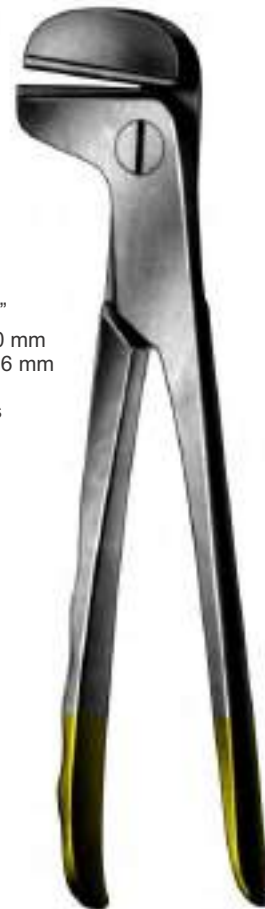

SS-04-380
240 mm / 9½"
Soft Wire 2,0 mm
Hard Wire 1,6 mm with carbide cutting edges



Specially hardened cutting edges

SS-04-381 145 mm / 5¾"
Soft Wire 1,5 mm
Hard Wire 1,0 mm



Specially hardened cutting edges

SS-04-382 220 mm / 8¾"
Soft Wire 3,5 mm
Hard Wire 2,5 mm
SS-04-383 145 mm / 5¾"
Soft Wire 2,0 mm



SS-04-384
320 mm / 12¾"
Hard Wire 3,0 mm
Cutter for cutting off KIRSCHNER wires, Tibia



Scissors 05

05 Scissors

Surgical Scissors	29,34	Waldmann	50
Baby-Laxer	46	Werthiem	42
Bandage Scissor	61,62	Wire Cutting Scissors	57
Beebee	57		
Bellucci Pick	55		
Bergmann	61		
Bonn	53		
Braun-Stadler	50		
Bruns	63		
Buck	58		
Busch	50		
Clothin Scissors, Plaster-of-Paris Shear	64		
Cottle	49		
Deaver	35		
Debakey	60		
Delicate Dissecting Scissors	46,48		
Diethrich	59		
Dissecting Scissors	35-39,43-46, 51,56		
Doyen	41		
Episiotomy Scissors	50		
Esmarch	61		
Goldmann-Fox	51, 52		
Gum Scissors	51-52		
Gynecological Scissors	40-42		
Heymann	49		
Hough Pick	55		
Iris Scissors	53, 54		
Kelly	43		
Knowles (Hi-Level)	61		
Knowles	61		
Laxer	46		
Laxer-Fino	46		
Lister	61		
Littauer	58		
Mayo	36		
Mayo-Harrington	36		
Mayo-Laxer	56		
Mayo-Noble	40		
Mayo-Stille	37,39		
Metzenbaum	39,43,44,56		
Metzenbaum-Fino	47,48		
Metzenbaum-Nelson	44		
Modell Usa	50		
Nasal Scissors	49		
Otology Picks	55		
Plaster-of-Paris Shears	63		
Potts-smith	60		
Scissors For Vascular Surgery	59,60		
Seutin	64		
Sims	41		
Sims-Siedolb	42		
Spencer	58		
Stevens	54		
Stitch Scissors	58		
Surgical Scissor	43		
Umbical Scissors	50		
Universal	57		
Wagner	51		



SS-05-101
12 cm



SS-05-102
13 cm



SS-05-103
14.5 cm



SS-05-104
16.5 cm

Surgical Scissors
Tijeras para Cirugia
Ciseaux a Chirurgie



SS-05-105
12 cm



SS-05-106
13 cm



SS-05-107
14.5 cm

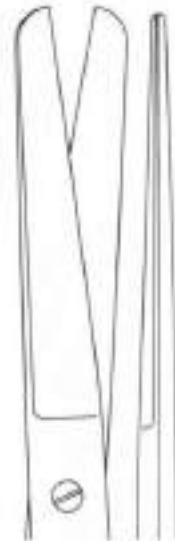

SS-05-108
16.5 cm

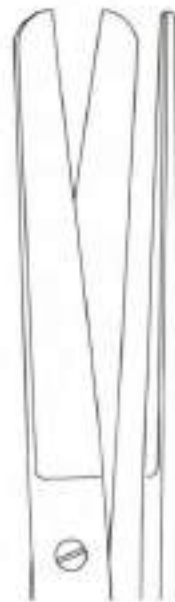

SS-05-109
18.5 cm

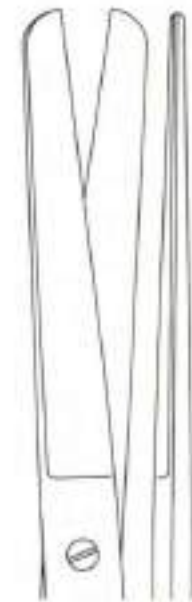

SS-105-110
20.5 mm

Surgical Scissors
 Tijeras para Cirugia
 Ciseaux a Chirurgie



SS-05-111
 12 cm



SS-05-112
 13 cm



SS-05-113
 14.5 cm

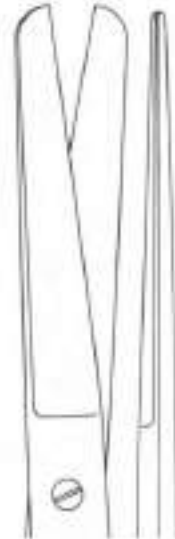

SS-05-114
 16.5 cm

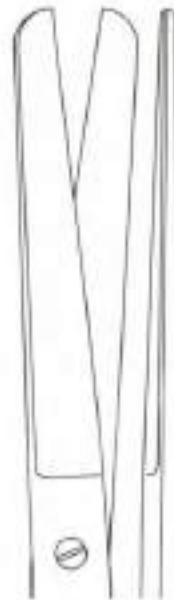

SS-05-115
 18.5 cm



SS-05-116
 20.5 cm

Surgical Scissors
Tijeras para Cirugia
Ciseaux a Chirurgie



SS-05-117
12 cm



SS-05-118
13 cm



SS-05-119
14.5 cm



SS-05-120
16.5 cm

Surgical Scissors
 Tijeras para Cirugia
 Ciseaux a Chirurgie

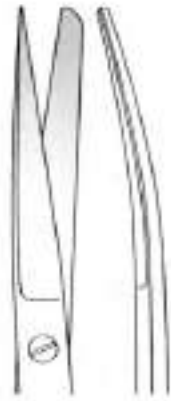

SS-05-121
 12 cm



SS-05-122
 13 cm



SS-05-123
 14.5 cm



SS-05-124
 16.5 cm



SS-05-125
 18.5 cm



SS-05-126
 20.5 cm

Surgical Scissors
Tijeras para Cirugia
Ciseaux a Chirurgie



SS-05-127
12 cm



SS-05-128
13 cm

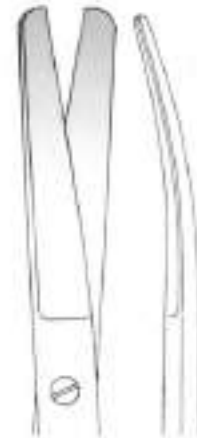

SS-05-129
14.5 cm



SS-05-130
16.5 cm



SS-05-131
18.5 cm



SS-05-132
20.5 cm

Surgical Scissors
 Tijeras para Cirugia
 Ciseaux a Chirurgie



Slender Pattern

1/2

Deaver

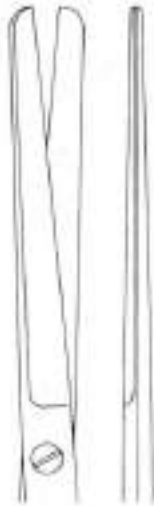

SS-05-133
 14.5 cm



SS-05-134
 14.5 cm



SS-05-135
 14.5 cm

1/4



Slender Pattern

1/2

Deaver



SS-05-136
 14.5 cm



SS-05-137
 14.5 cm

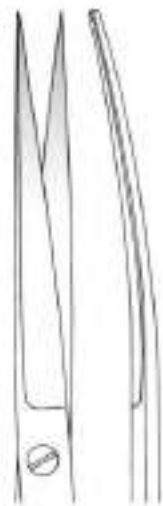

SS-05-138
 14.5 cm

1/4

Surgical Scissors
Tijeras para Cirugia
Ciseaux a Chirurgie

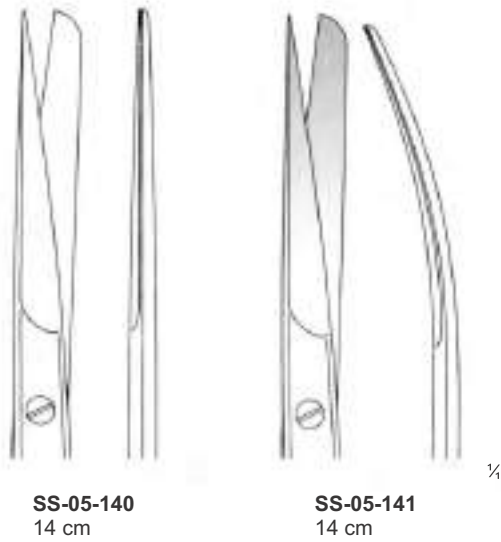
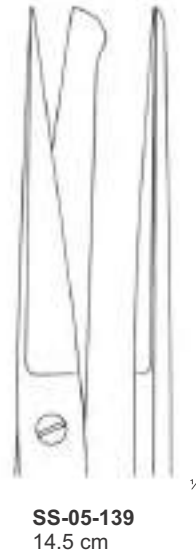

Dissecting Scissors
Tijeras para diseccion
Ciseaux a dissection



Mayo

SS-05-142
14.5 cm

SS-05-143
15 cm

SS-05-144
17 cm

SS-05-145
23.5 cm

SS-05-146
14.5 cm

SS-05-147
15 cm

SS-05-148
17 cm

SS-05-149
23.5 cm



Mayo-Harrington

SS-05-150
23 cm

SS-05-151
22.5 cm

SS-05-152
28 cm

Dissecting Scissors
Tijeras de Diseccion
Ciseaux a Dissection

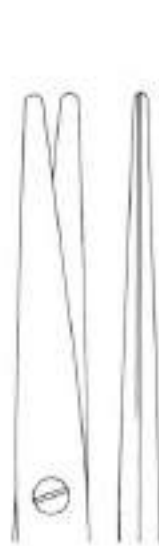

SS-05-153
16 cm



SS-05-154
19.5 cm

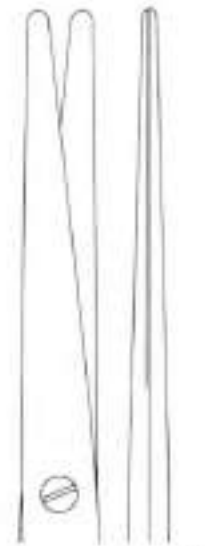

SS-05-155
21.5 cm



Mayo - Stille

1/2

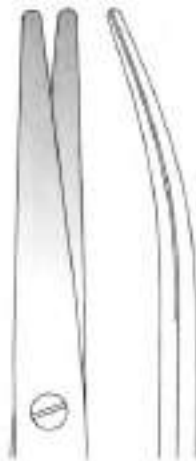

SS-05-156
16 cm

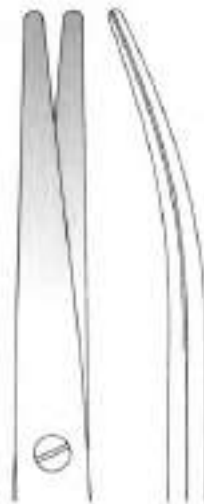

SS-05-157
19.5 cm



SS-05-158
21.5 cm

Dissecting Scissors
 Tijeras de Diseccion
 Ciseaux a Dissection



SS-05-159
 15 cm

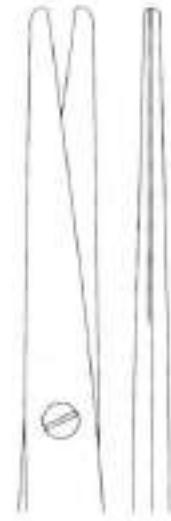

SS-05-160
 17 cm



Mayo - Stille



SS-05-161
 15 cm



SS-05-162
 17 cm

Dissecting Scissors
Tijeras de Diseccion
Ciseaux a Dissection



Mayo - Stille



Metzenbaum



Mayo-Noble
16.5 cm

1/2

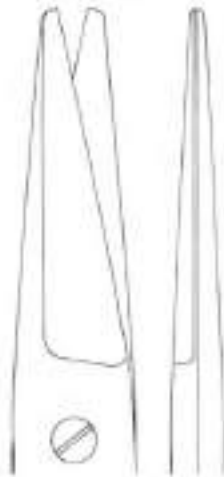

SS-05-172

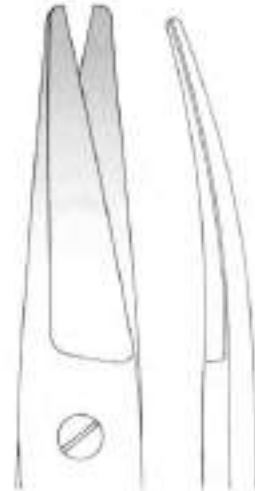

SS-05-173

1/2



SAPTESTAR
Manufacturer & Exporter Of Surgical, Dental & Veterinary Instruments

Gynecological Scissors
Tijeras para ginecologia
Ciseaux a gynecologie



Doyen
18.5 cm

1/2

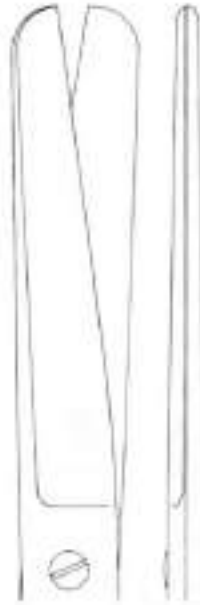

SS-05-174

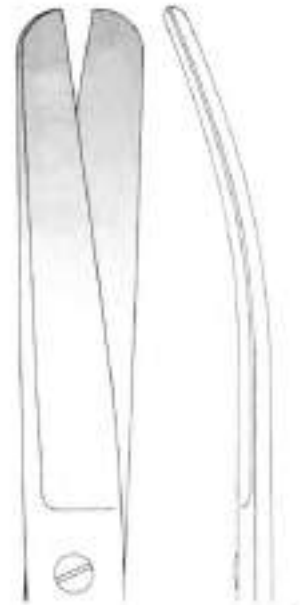

SS-05-175

1/2



Sims

1/2

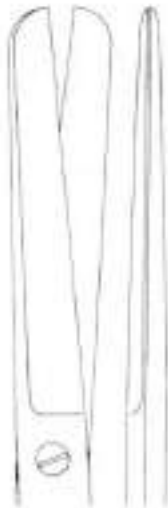

SS-05-176
20 cm

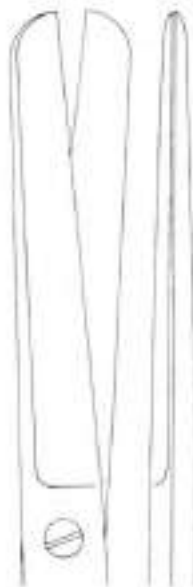

SS-05-177
23 cm



SS-05-178
20 cm



SS-05-179
23 cm

1/2



Sims Siebold

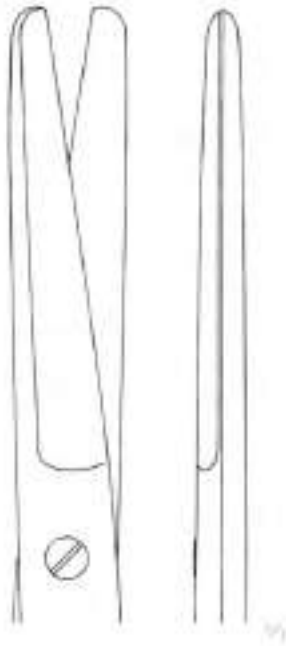

SS-05-180
24.5 cm



Sims-Siebold

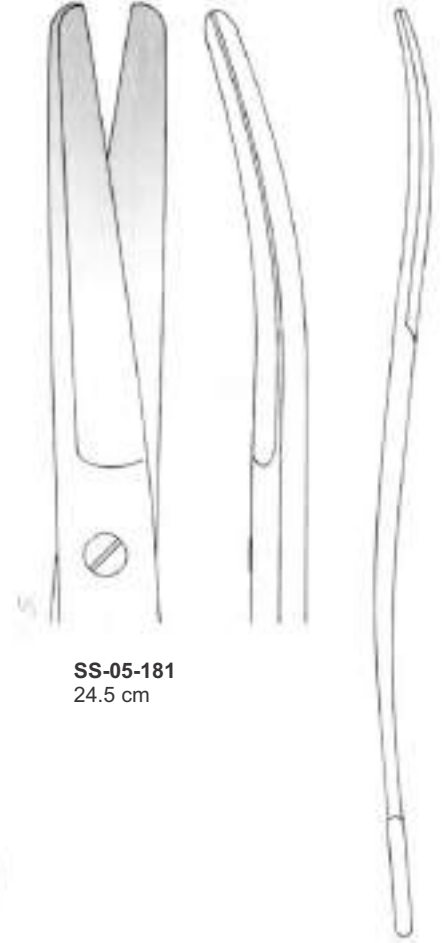

SS-05-181
24.5 cm

Gynecological Scissors
Tijeras para ginecologia
Ciseaux a gynecologie



Werthiem



SS-05-182
20 cm

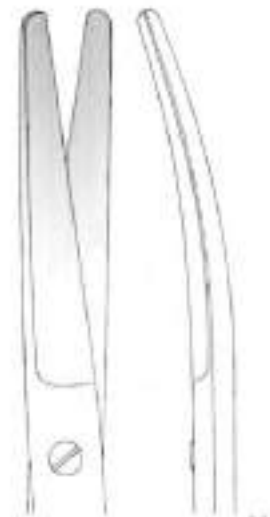

SS-05-183
23 cm

Surgical Scissors
Tijeras para Cirugia
Cisezux a Chirurgie

Dissecting Scissors
Tijeras de Diseccion
Ciseaux a Dissection



Kelly
16 cm

1/2



SS-05-184



SS-05-184



Metzenbaum
11.5 cm

1/2



SS-05-186



SS-05-187



Metzenbaum
15.5 cm

1/2



SS-05-188



SS-05-189

Dissecting Scissors
 Tijeras de diseccion
 Ciseaux a dissection



Metzenbaum
 14.5 cm

1/2



SS-05-190



SS-05-191



SS-05-192



SS-05-193



SS-05-194



SS-05-195

1/4



Metzenbaum Nelson

1/2



SS-05-196
 18 cm



SS-05-197
 20.5 cm

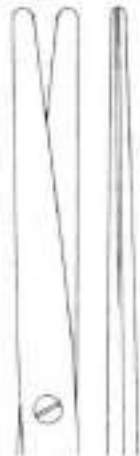

SS-05-198
 23 cm



SS-05-199
 26 cm



SS-05-200
 28.5 cm

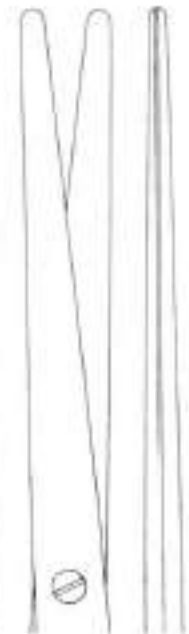

SS-05-201
 31 cm

1/4

Dissecting Scissors
Tijeras de diseccion
Ciseaux a dissection



Metzenbaum-Nelson



SS-05-202
18 cm



SS-05-203
20.5 cm



Metzenbaum-Nelson



SS-05-204
18 cm



SS-05-205
20.5 cm



SS-05-206
23. cm



SS-05-207
26 cm

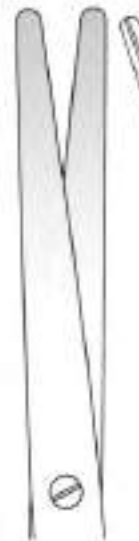

SS-05-208
28.5 cm



SS-05-209
31 cm



SAPTESTAR
Manufacturer & Exporter Of Surgical, Dental & Veterinary Instruments

Dissecting Scissors
Tijeras de diseccion
Ciseaux a dissection

Delicate Dissecting Scissors
Tijeras finas de diseccion
Ciseaux find a dissection



Laxer
16 cm



Baby-Laxer
10 cm



Laxer-Fino
SS-05-214
16.5 cm
slender pattern
modelo delgado
modele gracile



Laxer-Fino
SS-05-215
16.5 cm
slender pattern
modelo delgado
modele gracile

Delicate Dissecting Scissors
Tijeras finas de diseccion
Ciseaux fins a dissection



Metzenbaum-Fino



SS-05-216
18 cm



SS-05-217
20 cm

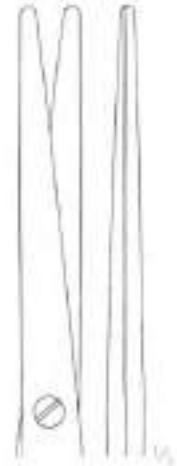

SS-05-218
23 cm

Slender pattern
modelo delgado
modèle gracile



Metzenbaum Fino
SS-05-219
14.5 cm
Slender pattern
modelo delgado
modèle gracile



Metzenbaum Fino
SS-05-220
14.5 cm
Slender pattern
modelo delgado
modèle gracile



Metzenbaum Fino
SS-05-221
14.5 cm
Slender pattern
modelo delgado
modèle gracile



Metzenbaum Fino
SS-05-222
14.5 cm
Slender pattern
modelo delgado
modèle gracile



SAPTESTAR
Manufacturer & Exporter Of Surgical, Dental & Veterinary Instruments

Delicate Dissecting Scissors
Tijeras finas de diseccion
Ciseaux fins a dissection



Metzenbaum Fino

1/2

Slender pattern
modelo delgado
modèle gracile



SS-05-223
18 cm



SS-05-224
20 cm



SS-05-225
23 cm

1/2



Metzenbaum Fino

1/2

S-shaped
Slender pattern
forma S
modelo delgado
courbes en S
modèle gracile



SS-05-226
18 cm



SS-05-227
20 cm



SS-05-228
23 cm

Nasal Scissors
 Tijeras nasales
 Ciseaux nasaux



Cottle

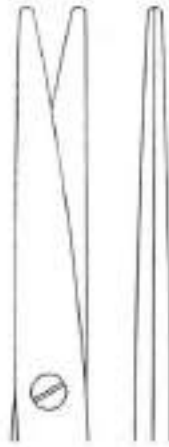

SS-05-229
 16 cm



Heymann



SS-05-230
 18.5 cm



Heymann



SS-05-231
 18.5 cm
 one toothed cutting edge
 una hoja dentada
 une lame denetelée



SAPTESTAR
Manufacturer & Exporter Of Surgical, Dental & Veterinary Instruments

Episiotomy Scissors
Tijeras para episiotomia
Ciseaux a episitomie

Umbilical Scissors
Tijeras Umbilicales
Ciseaux cordon ombilical



SS-05-232
18 cm
one toothed cutting edge
una hoja dentada
une lame dentelee

Waldmann



SS-05-233
14.5 cm

Braun-Stadler

one toothed cutting edge
una hoja dentada
une lame dentelee



SS-05-234
22 cm

Braun-Stadler



Modell USA
SS-05-235
10.5 cm



Busch
SS-05-236
16 cm

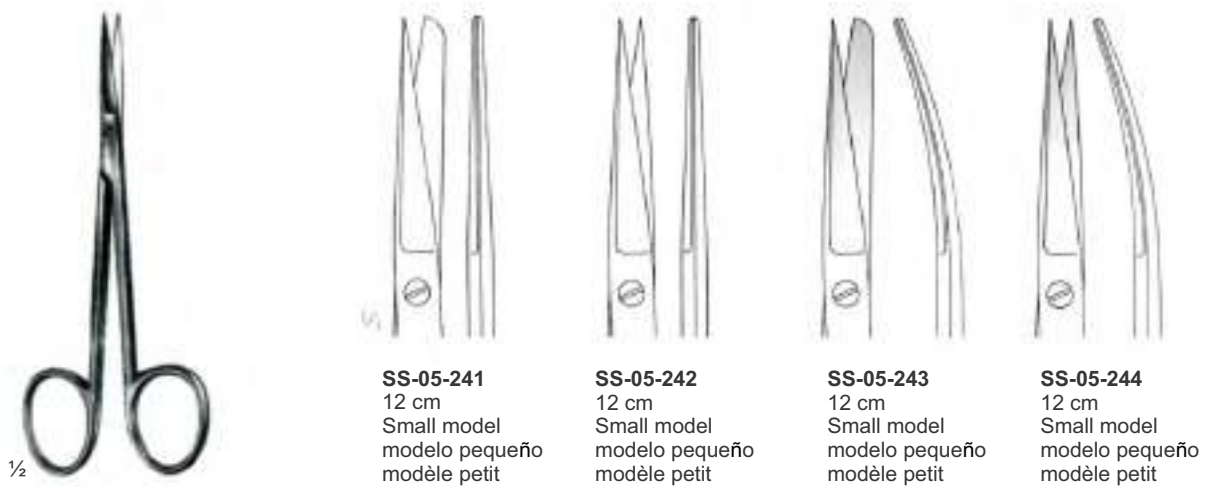



SAPTESTAR
Manufacturer & Exporter Of Surgical, Dental & Veterinary Instruments

Gum Scissors
Tijeras para encias
Ciseaux a gencives

1 Blade Serrated
1 Hoja dentada
1 Lame dentelée



Straight
Rectas
Droits

Goldmann-Fox
SS-05-245
13 cm / 5"

1 Blade Serrated
1 Hoja dentada
1 Lame dentelée



curved
curvas
courbes

Goldmann-Fox
SS-05-246
13 cm / 5"

1 Blade Serrated
1 Hoja dentada
1 Lame dentelée



S-curved
curva forma S
courbes en S

Goldmann-Fox
SS-05-247
13 cm / 5"

Iris scissors
 Tijeras para iridectomia
 Ciseaux a iridectomie



SS-05-248
9 cm



SS-05-249
10 cm



SS-05-250
9 cm



SS-05-251
10 cm



SS-05-252
10 cm



SS-05-253
9 cm



Bonn



SS-05-254
9 cm



Bonn

Extra flat blades
 hojas muy delgadas
 lames extrêmement plat



SAPTESTAR
Manufacturer & Exporter Of Surgical, Dental & Veterinary Instruments

Iris scissors
Tijeras para iridectomia
Ciseaux a iridectomie



Stevens
11.5 cm



SS-05-255



SS-05-256



SS-05-257



SS-05-258



Stevens
110 mm



SS-05-259



SS-05-260



SS-05-261



SS-05-262

Iris scissors
Tijeras para iridectomia
Ciseaux a iridectomie



11.5 cm



SS-05-263



SS-05-264



SS-05-265



SS-05-266



12.5 cm



SS-05-267



SS-05-268



11.5 cm



SS-05-269



SS-05-270



SS-05-271
11.5 cm

Enucleation Scissors
Tijera para enucleación
Ciseaux à énucléation

Dissecting Scissors
Tijeras de diseccion
Ciseaux a dissection



Metzenbaum

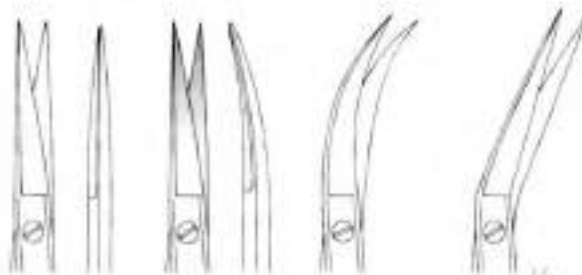

SS-05-272
18 cm / 7"

SS-05-273
20 cm / 8"

1/2

With special cutting edge
con filo especial
avec affûtage spéciale



SS-05-274
23 cm / 9"

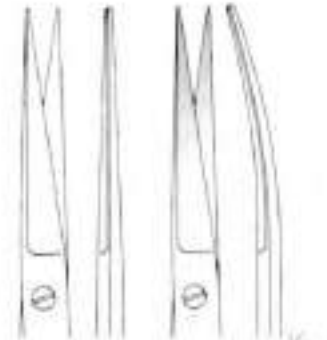

Metzenbaum

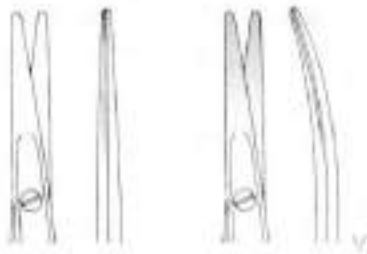

SS-05-275
14.5 cm

SS-05-276
18 cm

1/2

With special cutting edge
con filo especial
avec affûtage spéciale



Mayo-Lexer
16 cm



SS-05-277

1/2

Slender pattern
With special cutting edge
modelo delgado
con filo especial
modèle gracile
avec affûtage spéciale

Wire Cutting Scissors
Tijeras para alambre
Cisailles a fils



Universal
12 cm



SS-05-278
Toothed
dentada
dentelée

1/2



Beebee
10.5 cm

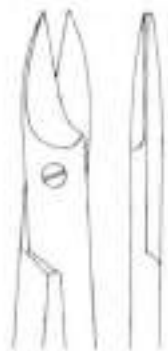

SS-05-279



SS-05-280



SS-05-281
One toothed cutting edge
una hoja dentada
une lame dentelée



SS-05-282
One toothed cutting edge
una hoja dentada
une lame dentelée

1/2

Stitch Scissors
Tijeras para hilos
ciseaux a ligatures



Scissors for Vascular Surgery
Tijeras para cirugía vascular
Ciseaux pour la chirurgie vasculaire



Diethrich
18 cm / 7"

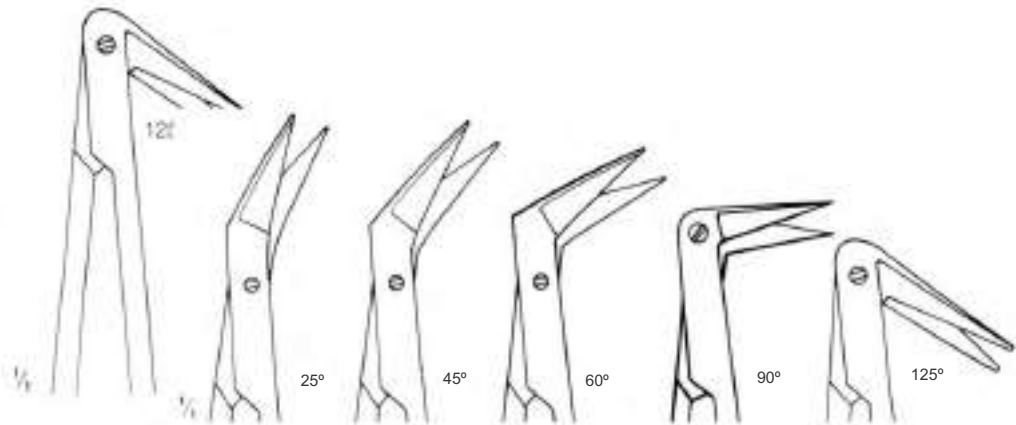

SS-05-288-A
With guidebar
con dispositivo de guía
avec dispositif de guidage

SS-05-288
18 cm / 7"

SS-05-289
18 cm / 7"

SS-05-290
18 cm / 7"

SS-05-291
18 cm / 7"

SS-05-292
18 cm / 7"



Diethrich
13 cm / 5"

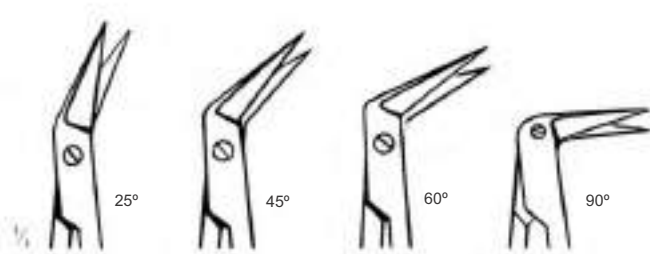

SS-05-293
13 cm / 5"

SS-05-294
13 cm / 5"

SS-05-295
13 cm / 5"

SS-05-296
13 cm / 5"



SAPTESTAR
Manufacturer & Exporter Of Surgical, Dental & Veterinary Instruments

Scissors for Vascular Surgery
Tijeras para cirugía vascular
Ciseaux pour la chirurgie vasculaire



DeBakey

TC H / Gold



SS-05-297
16 cm



SS-05-298
16 cm

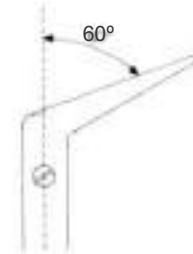

SS-05-299
16 cm

SS-05-300
23 cm

SS-05-301
23 cm

SS-05-302
23 cm

SS-05-303
28 cm

SS-05-304
28 cm

SS-05-305
28 cm



SS-05-306
19 cm



SS-05-307
19 cm



SS-05-308
19 cm

1/2



Potts-Smith

Bandage Scissors
Tijeras para vendajes
Ciseaux pour pansements

Universal bandage- & cloth scissors made of acid-proof stainless steel, with toothed edges & plastic handles, autoclavable up to 143° C

Tijeras universales para vendajes y vestidos acero inoxidable y resistente los acidos, con hoja dentada y mango de plastico, esterilizable en autoclave hasta 143° C.

Ciseaux universels a' pansements et a' ve'tements en acier inoxydable resistant aux acides, a' lames dentelees et manches en matiere plastique, sterilisables a' l' autoclave jusqu' a' 143° C.



1/2

SS-05-320
14.5 cm



1/2

SS-05-321
17 cm



1/2

SS-05-322
19 cm

Plaster-of-paris Shears
Cizallas para vendajes enyesados
Cisailles pour appareils plâtrés



Brun's
24 cm

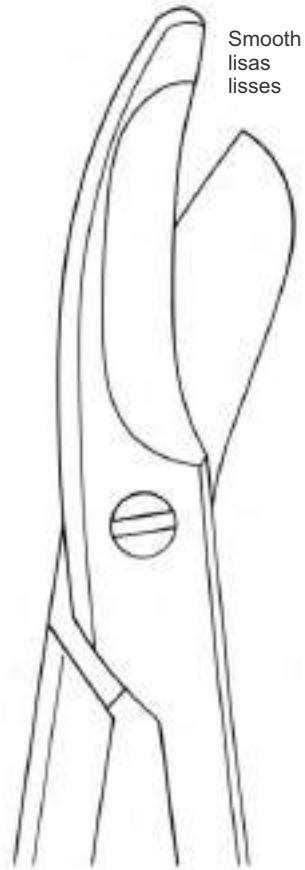

Smooth
lisas
lisses

SS-05-323

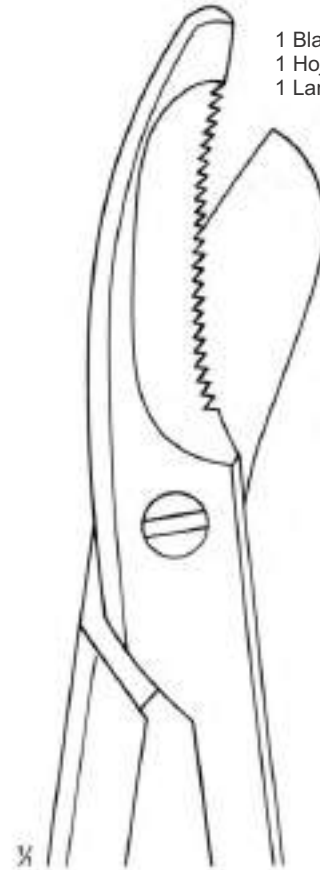

1 Blade serrated
1 Hoja dentada
1 Lame dentelée

SS-05-324

Clothing Scissors, Plaster-of-paris Shears
 Tijeras para vestidos, Cizallas para vendajes enyesados
 Cisailles pour pansements et appareils plâtrés

1 Blade serrated
 1 Hoja dentada
 1 Lame dentelee



SS-05-325
 20 cm

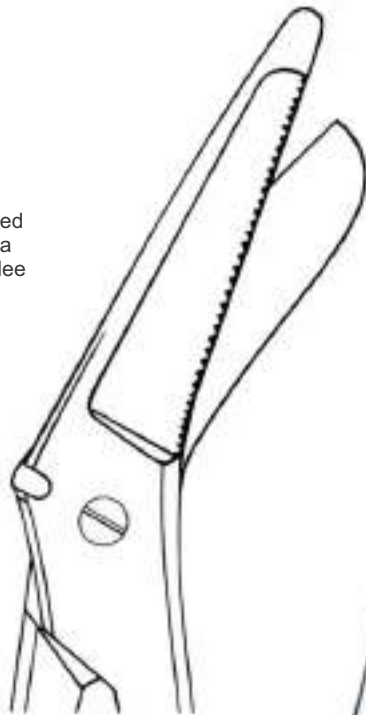

Seutin
SS-05-326
 23 cm

1 Blade serrated
 1 Hoja dentada
 1 Lame dentelee



Seutin
SS-05-327
 23 cm



Dissecting Forceps 06

06 Disecting Forceps

Adlerkreutz	81
Adson	74,85,87
Adson-Brown	84
Austin	76
Bonaccolto	74
Bonney	71,79
Brophy	72,83
Brown	84
Cairns-Dott	73
Charnley	80
Cushing	72
Delicate Dissecting Forcep	72-74
Delicate Tissue Forcep	82,83,85
Denis-Browne	89
Dissecting Forceps	69,70
Duval	89
Ear & Nasal Dressing, Forceps, Angular	87,88
Feilchenfeld	90
Gerald	73,83
Gillies	73,83
Graeffe	84
Grasping Forceps	89
Gruenwald	87
Hunter	90
Jackson-Burrows	80
Jansen	87
Jefferson	74,85
Jess	84
Kuhne	86
Lane	79
Lazar	76
Lucae	87
Mc Indol	73,83
Medium Dissecting Forcep	69,77
Micro Forcep	75,76
Micro-Adson	74,58
Micro-Adson-bierner	85
Microscopic Forceps	86
Nelson	89
Ochsner	71
Officer	78
Peet	90
Plaster Spreaders	90
Ramsey	71,80
Russ,Modell	81
Semkon	73,82
Standard	69,77
Stieglitz	90
Stille-Barraya	81
Strassburger Modell	80
Thorpe	74
Tissue Forcep	77-81
Tissue Forceps, Delicate Tissue Forcep	84
Treves	79
Troeltsch	88
Tuttle	89
Waugh	83

Dissecting Forceps
Pinzas de diseccion
Pincas a dissection

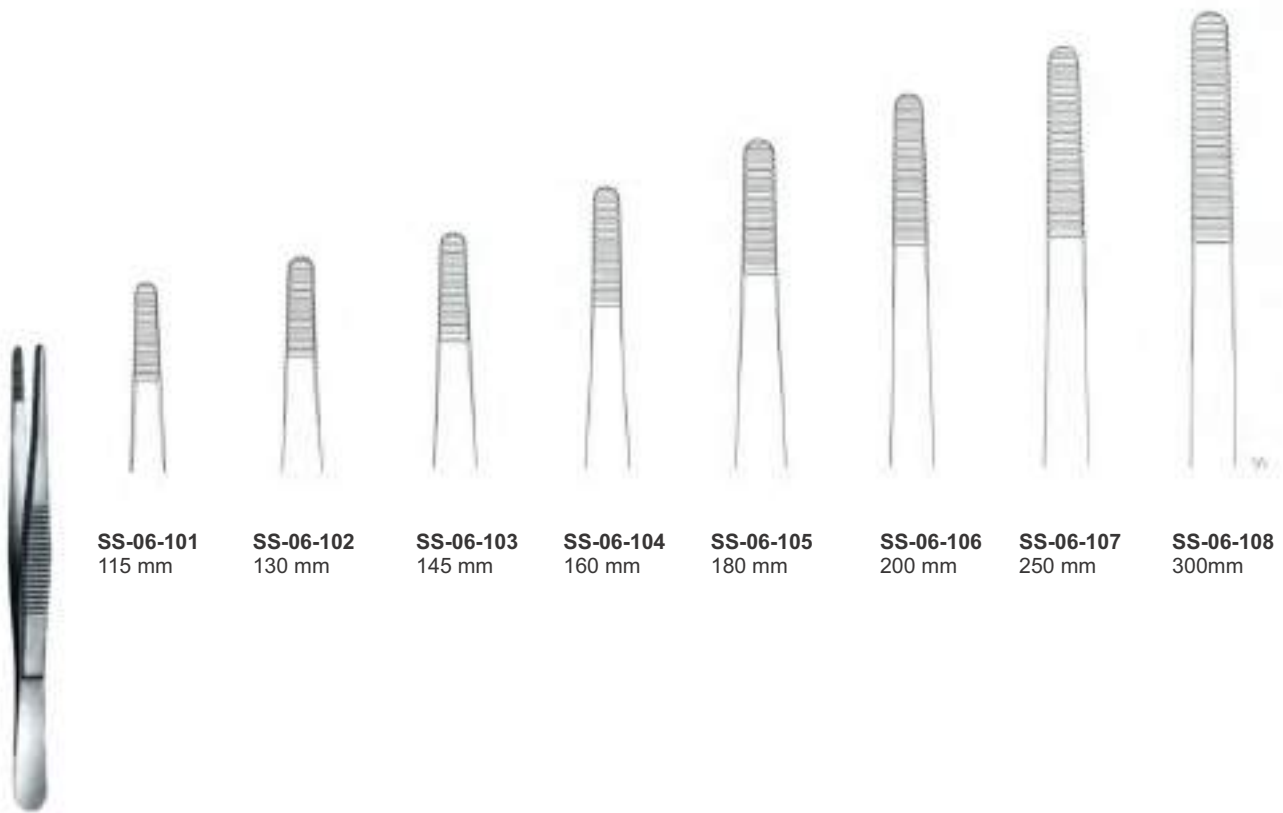

Standard

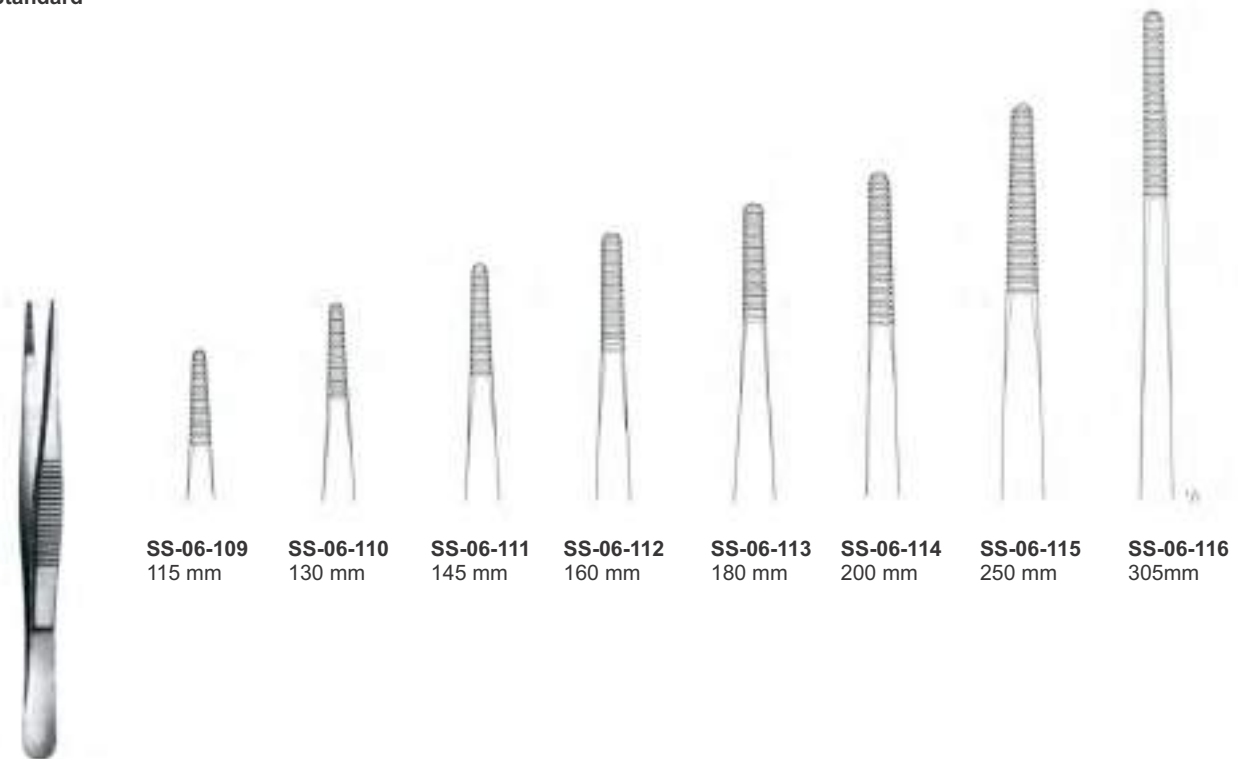

Medium

Dissecting Forceps
 Pinzas de diseccion
 Pincas a dissection



SS-06-117
130 mm



SS-06-118
145 mm



SS-06-119
145 mm



SS-06-120
130 mm



SS-06-121
150 mm



SS-06-122
170 mm



SS-06-123
200 mm

Dissecting Forceps
Pinzas de diseccion
Pincas a dissection



Ochsner
SS-06-124
Ligature forceps
145 mm



SS-06-125
125 mm



SS-06-126
155 mm



Bonney
SS-06-127
175 mm



Ramsey
SS-06-128
180 mm



Delicate Dissecting Forceps
 Pinzas finas de diseccion
 Pincas fines pour dissection



Cushing

SS-06-129
180 mm



SS-06-130
200 mm



SS-06-131
200 mm



SS-06-132
250 mm



Brophy
200 mm / 8"

SS-06-133



SS-06-134



SS-06-135
185 mm



SS-06-136
200 mm



SS-06-137
200 mm





SAPTESTAR
Manufacturer & Exporter Of Surgical, Dental & Veterinary Instruments

Delicate Dissecting Forceps
Pinzas finas de diseccion
Pinces fines pour dissection



Delicate Dissecting Forceps
Pinzas finas de diseccion
Pinces fines pour dissection



Thorpe
SS-06-148
120 mm



Micro-Adson
SS-06-149
120 mm



Adson
SS-06-150
120 mm



Micro-Adson
SS-06-151
150 mm



Adson
SS-06-152
180 mm



Jefferson
SS-06-153
180 mm



100 mm



SS-06-154



SS-06-155



SS-06-156



Bonaccolto
SS-06-157
110 mm



SS-06-158
115 mm

Micro Forceps
 Micro Pinzas
 Micro Pinces

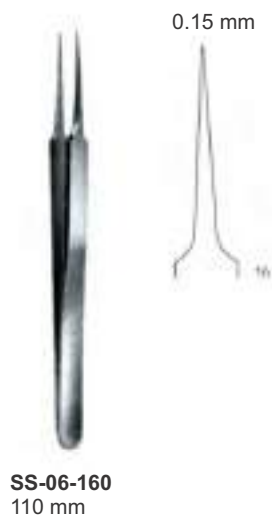

Micro Forceps
Micro Pinzas
Micro Pinces





SAPTESTAR
Manufacturer & Exporter Of Surgical, Dental & Veterinary Instruments

Tissue Forceps
Pinzas quirurgicas
Pinces chirurgicales



Standard

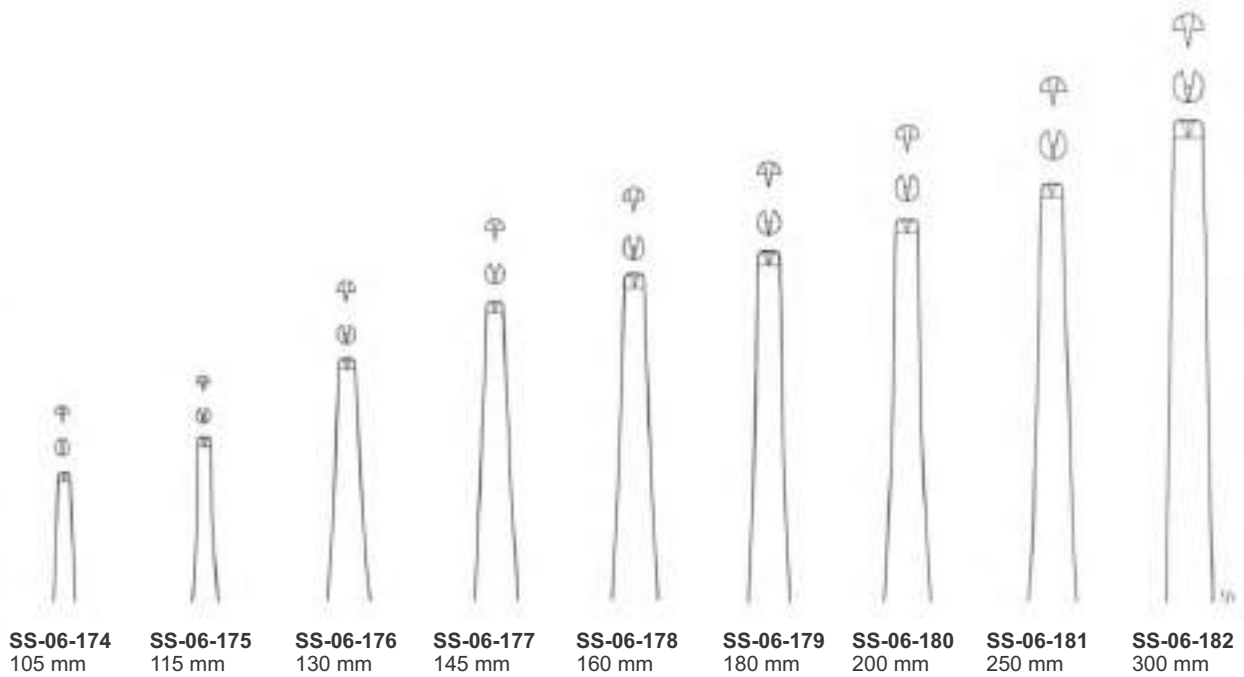

Medium

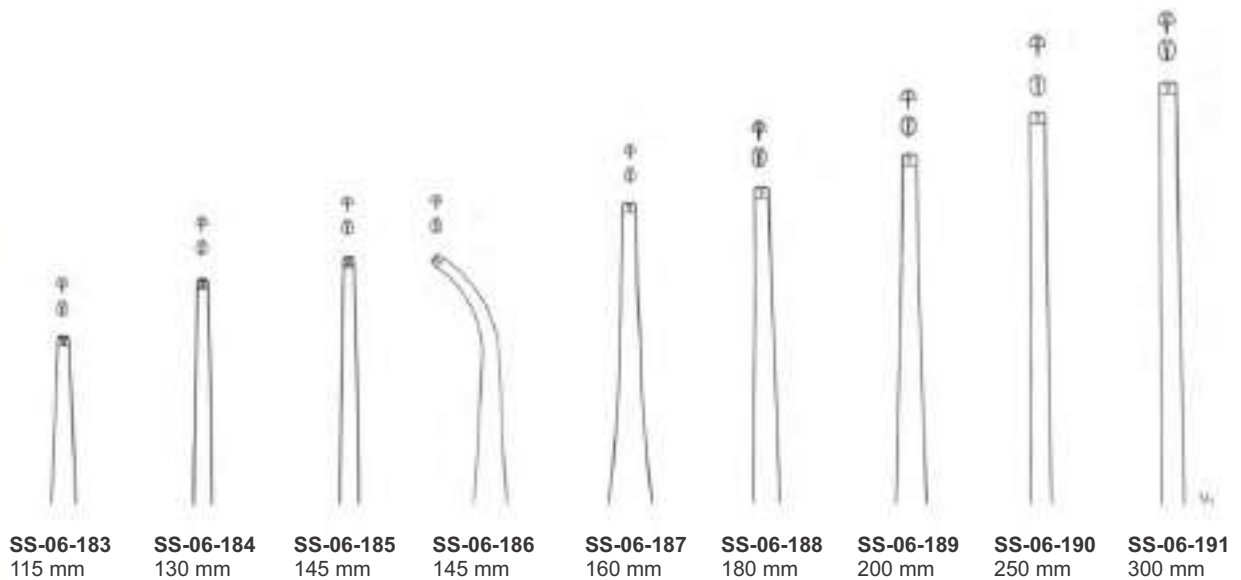

Tissue Forceps
Pinzas quirurgicas
Pincas chirurgicales

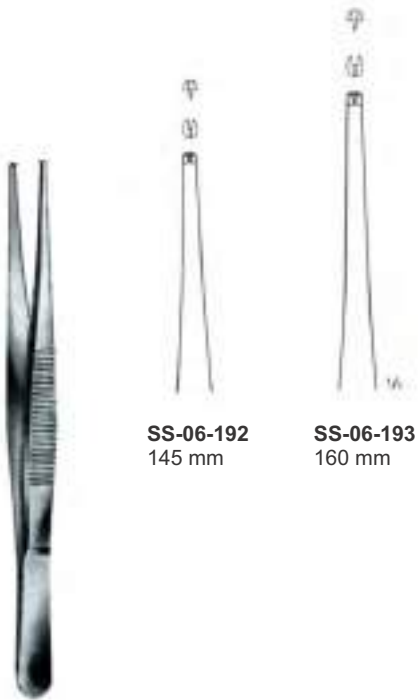

SS-06-192
145 mm

SS-06-193
160 mm

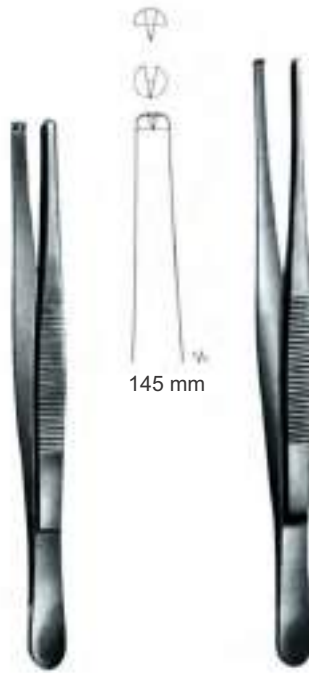

145 mm

SS-06-194
Heavy Pattern

2 x 3 teeth

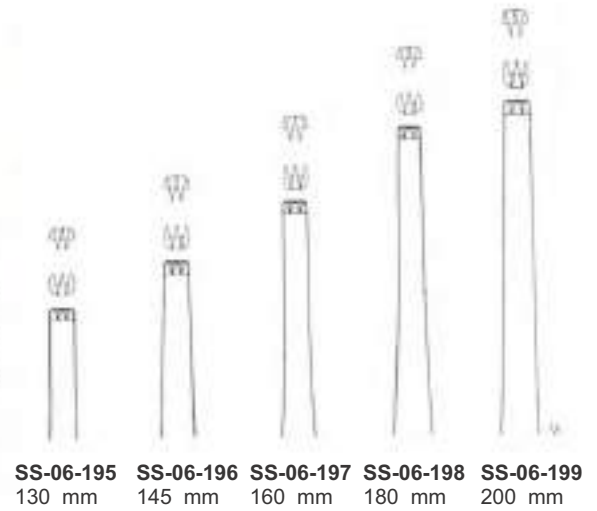

SS-06-195
130 mm

SS-06-196
145 mm

SS-06-197
160 mm

SS-06-198
180 mm

SS-06-199
200 mm

Stronger as SS-06-177 & SS-06-178
But fine then SS-06-185 & SS-06-187

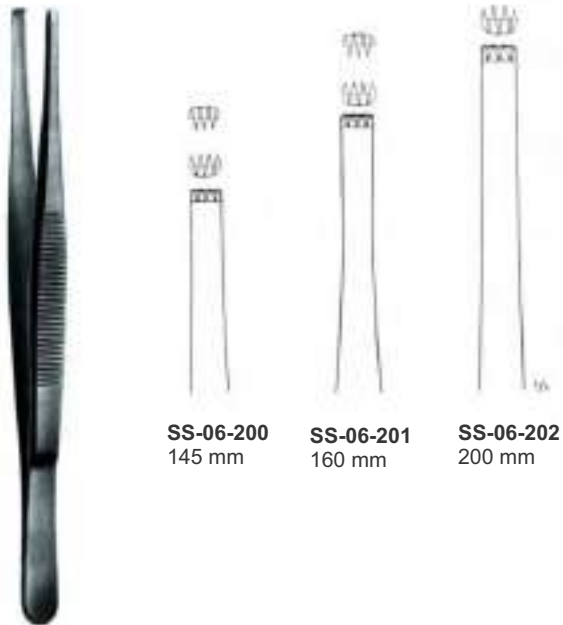

SS-06-200
145 mm

SS-06-201
160 mm

SS-06-202
200 mm

3 x 4 teeth



SS-06-203
4 x 5 teeth
145 mm

Officer
SS-06-204
4 x 5 teeth
150 mm



SAPTESTAR
Manufacturer & Exporter Of Surgical, Dental & Veterinary Instruments

Tissue Forceps
Pinzas quirurgicas
Pinces chirurgicales



Lane



SS-06-205
125 mm
1 x 2 teeth



SS-06-206
145 mm
1 x 2 teeth



SS-06-207
145 mm
2 x 3 teeth



SS-06-208
175 mm
1 x 2 teeth



SS-06-209
175 mm
2 x 3 teeth



Treves



SS-06-210
125 mm
1 x 2 teeth



SS-06-211
150 mm
1 x 2 teeth



Bonney
SS-06-212
175 mm



Tissue Forceps
Pinzas quirurgicas
Pinces chirurgicales



Jackson-Burrows
SS-06-213
140 mm
1 x 2 teeth

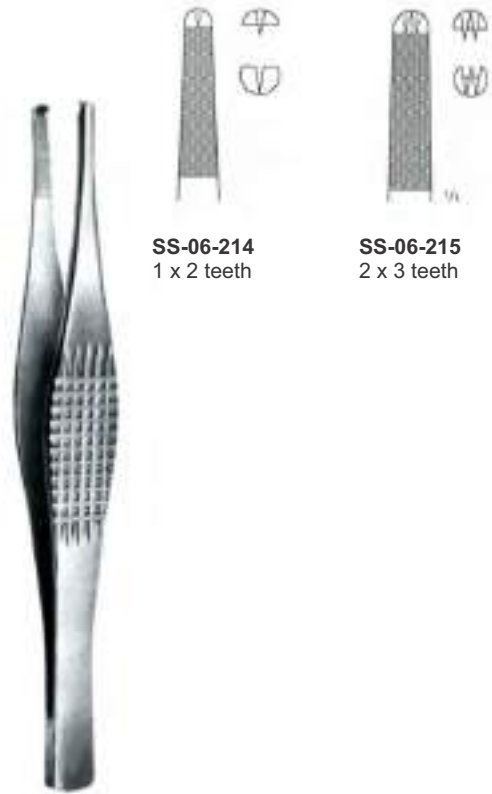

SS-06-214
1 x 2 teeth

SS-06-215
2 x 3 teeth

Ramsey
180 mm



Charnley
SS-06-216
180 mm



SS-06-217
150 mm

SS-06-218
200 mm

Strassburger Modell



SAPTESTAR
Manufacturer & Exporter Of Surgical, Dental & Veterinary Instruments

Tissue Forceps
Pinzas quirurgicas
Pinces chirurgicales



SS-06-219
150 mm



SS-06-220
200 mm



SS-06-221
180 mm



SS-06-222
200 mm



SS-06-223
250 mm

Adlerkreutz
Vascular-and tumor forceps

Stille-Barraya
Vascular-and tumor forceps



Russ.Modell
SS-06-224



Russ.Modell
SS-06-225



Delicate Tissue Forceps
Pinzas finas quirurgicas
Pinces finces chirurgicales



Very delicate
100 mm



SS-06-229
100 mm



SS-06-230
110 mm



SS-06-231
2 x 3 teeth
110 mm



SS-06-232
125 mm



SS-06-233
125 mm
2 x 3 teeth



SS-06-234
150 mm



SS-06-235
125 mm



SS-06-236
145 mm



Semken

Semken



SAPTESTAR
Manufacturer & Exporter Of Surgical, Dental & Veterinary Instruments

Tissue Forceps
Pinzas quirurgicas
Pinces chirurgicales

Delicate Tissue Forceps
Pinzas finas quirurgicas
Pinces fines chirurgicales



Adson-Brown
SS-06-247
Sharp tissue forceps
120 mm



Brown
SS-06-248
150 mm



Graeffe
SS-06-249
110 mm



Graeffe
SS-06-250
with catch
110 mm



Jess
SS-06-251
110 mm



SS-06-252
with plateau
120 mm

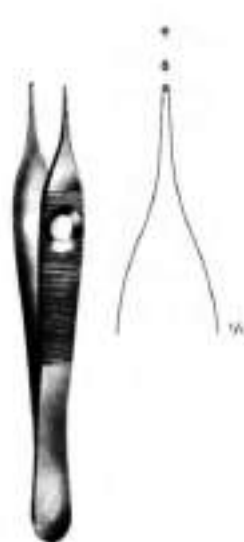

SS-06-253
120 mm



SS-06-254
120 mm

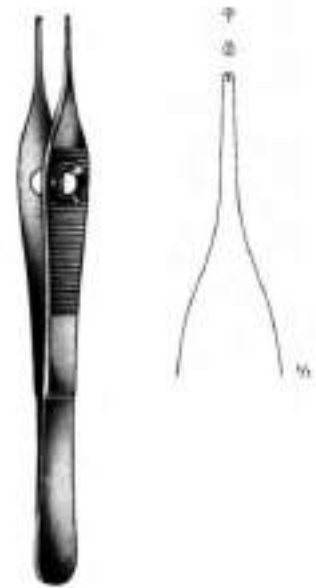

SS-06-255
150 mm

Delicate Tissue Forceps
Pinzas finas quirurgicas
Pinces fines chirurgicales



Micro-Adson-Biemer
SS-06-256
Teeth in oblique position
120 mm



Micro-Adson
SS-06-257
120 mm



Adson
SS-06-258
120 mm



Adson
SS-06-259
with plateau
120 mm

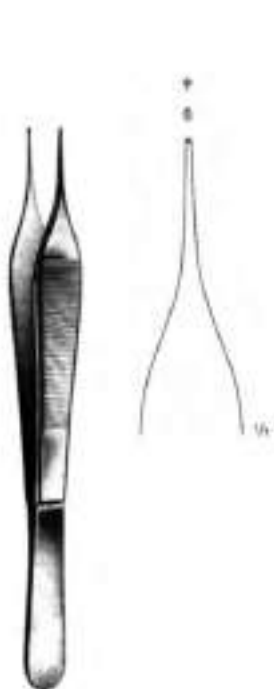

Micro-Adson
SS-06-260
150 mm



Adson
SS-06-261
1 x 2 teeth
180 mm



Jefferson
SS-06-262
1 x 2 teeth
180 mm



Adson
SS-06-263
120 mm

Microscopic Forceps
 Pinzas para microscopia
 Pinces pour microscopie

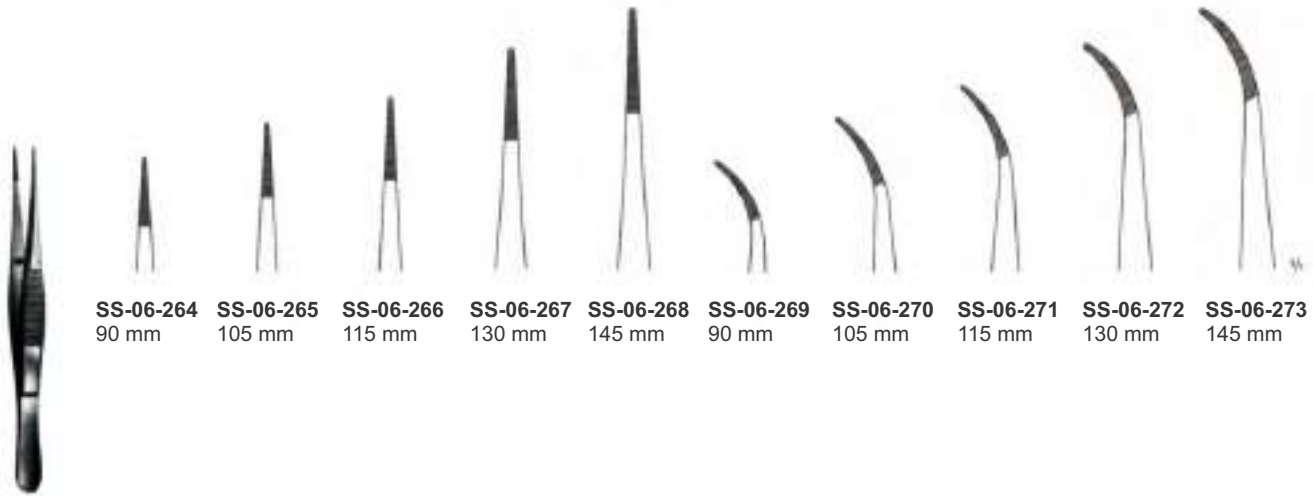

SS-06-264 90 mm	SS-06-265 105 mm	SS-06-266 115 mm	SS-06-267 130 mm	SS-06-268 145 mm	SS-06-269 90 mm	SS-06-270 105 mm	SS-06-271 115 mm	SS-06-272 130 mm	SS-06-273 145 mm
---------------------------	----------------------------	----------------------------	----------------------------	----------------------------	---------------------------	----------------------------	----------------------------	----------------------------	----------------------------



SS-06-274
100 mm



SS-06-275
100 mm



SS-06-276
100 mm



Kuhne
SS-06-277
 Cover glass forceps
 105 mm

Ear & Nasal Dressing Forceps, Angular
Pinzas auriculares y nasales, acodadas
Pinces auriculaires et nasales, angulees



Lucae
SS-06-278
140 mm



Lucae
SS-06-279
1 x 2 teeth
140 mm



Jansen
SS-06-280
160 mm



Adson
SS-06-281
175 mm



Gruenwald
SS-06-282
200 mm



SS-06-283
smooth jaws
160 mm



SS-06-284
1 x 2 teeth
160 mm



SS-06-285
smooth jaws
185 mm



SS-06-286
1 x 2teeth
200 mm

Ear & Nasal Dressing Forceps, Angular
 Pinzas auriculares y nasales, acodadas
 Pincas auriculaires et nasales, angulees



**Troeltsch
 SS-06-287**
 100 mm



**Troeltsch
 SS-06-288**
 115 mm



**Troeltsch
 SS-06-289**
 1 x 2 teeth
 115 mm



**Troeltsch
 SS-06-290**
 Cross action
 120 mm



**Troeltsch
 SS-06-291**
 140 mm



**Troeltsch
 SS-06-292**
 170 mm

Grasping Forceps
Pinzas de agarre
Pinces pour saisir les tissus



Tuttle
SS-06-293
Lung dissecting forceps
230 mm

Nelson
SS-06-294
Lung dissecting forceps
230 mm

Duval
SS-06-295
Intestinal forceps
140 mm

Denis-Browne
SS-06-296
Intestinal forceps
190 mm



SAPTESTAR
Manufacturer & Exporter Of Surgical, Dental & Veterinary Instruments

Splinter Forceps
Pinzas para escayolas
Pinces ecartantes a platre



SS-06-297
80 mm



Feilchenfeld

SS-06-298
80 mm



SS-06-299
90 mm



SS-06-300
115 mm



Hunter
SS-06-301
105 mm



Stieglitz
SS-06-302
140 mm



Stieglitz
SS-06-303
140 mm



Peet
SS-06-304
120 mm



Needle Holders 07

07 Needle Holders

Adson	94
Brown	94
Collier	93
Crile	98
Crile-Murray	94
Crile-Wood	94
Derf	93
Finochietto	96
Gillies	97
Hegar-Baumgartner	93
Halsey	93
Heaney	95
Jamison	95
Johnson	96
Lichtenberg	98
M.G. Hospital	94
Masson	95
Mathieu	98
Mayo-Hegar	95
Metzenbaum	94
Needle Holder	93-98
Neivert	93
Olsen-Hegar	97
Stratte	97
Toennis	98
Wangensteen	96
Webster	93

Needle Holders
Porta-agujas
Porte-aiguilles



SS-07-101
12 cm

one fenestrated jaw
un lado de la boca
fenestrada
uncote de mors fenetre



Derf



SS-07-102
13 cm

Serration
boca con estrias
longitudinales.
Mors avec rainures
Longitudinales



Collier



SS-07-103
12,5 cm
grooved jaw
bca acanalada
mors strie

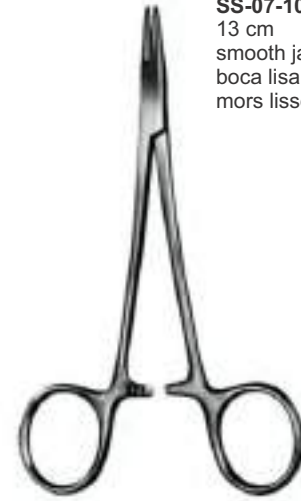

Webster



SS-07-104
13 cm
smooth jaw
boca lisa
mors lisse



SS-07-105
13,5 cm
smooth jaw
boca lisa
mors lisse



Halsey

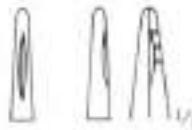

SS-07-106
12,5 cm
smooth jaw, special groove
boca lisa, especialmente acanalada
mors lisse, avce stries speciales



Neivert



SS-07-107
14,5 cm



Hegar-Baumgartner

Needle Holders
 Porta-agujas
 Porte-aiguilles



SS-07-108
 13 cm

Heavy pattern
 modelo fuerte
 modele fort

Diagonally serrated jaw
 boca estriada transversalmente
 mors strie transversalment

Brown



SS-07-109
 18 cm

SS-07-110
 15 cm
 slender pattern
 modelo delgado
 modele gracile

Crile-Murry



SS-07-111
 15 cm

Crile-Wood



SS-07-112
 18 cm
 one fenestrated jaw
 un lado de la boca fenestrada
 un cote de mors fenetre

Adson



SS-07-113
 18,5 cm
 one grooved and fenestrated jaw
 un lado de la boca acanalado y fenestrado
 un cote de mors strie et fenetre

Metzenbaum



SS-07-114
 17.5 cm
 heavy pattern
 modelo fuerte
 modele fort

M.G Hospital

Needle Holders
Porta-agujas
Porte-aiguilles

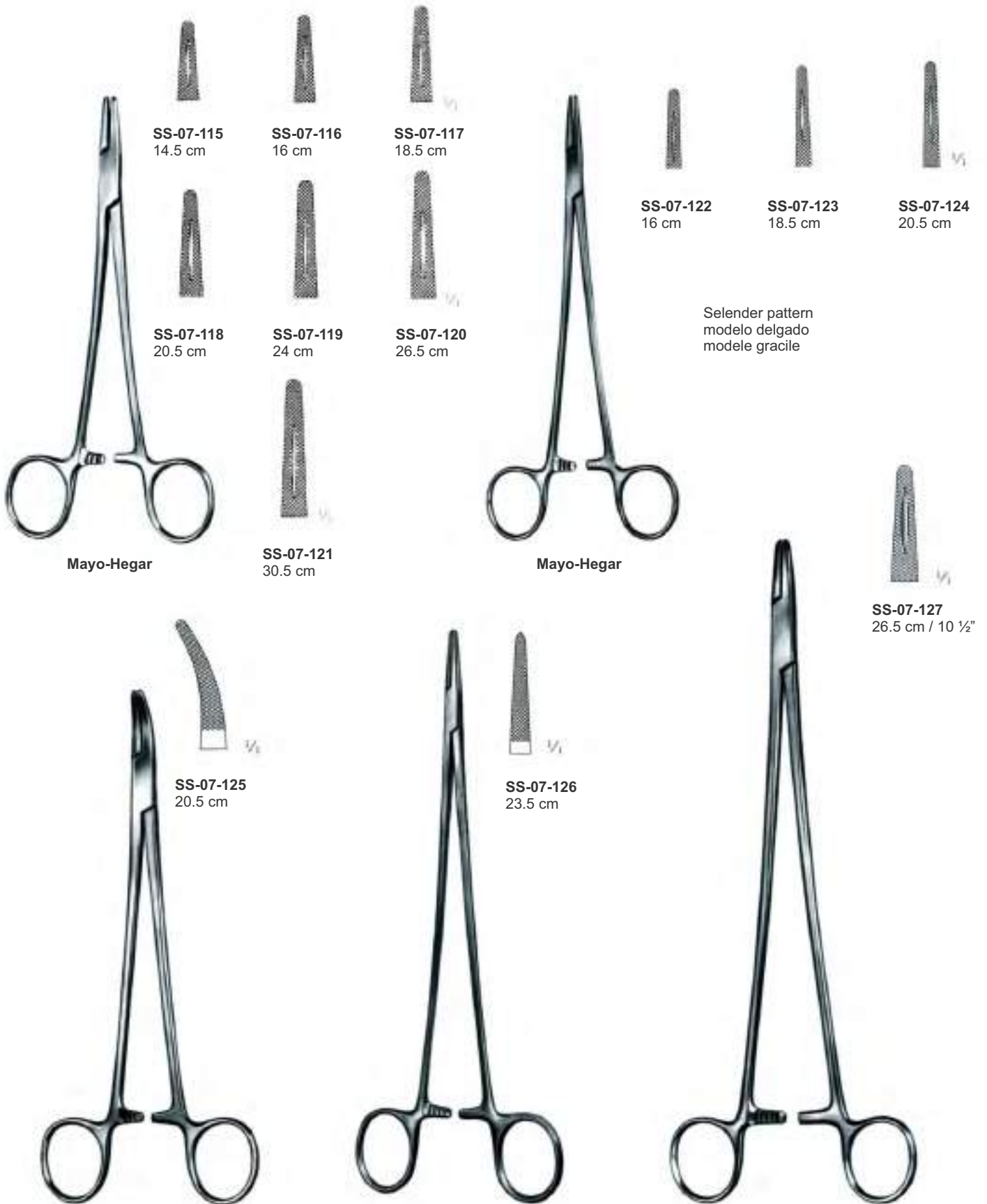



Needle Holders
 Porta-agujas
 Porte-aiguilles



SS-07-131
 23 cm

Stratte



SS-07-132
 14 cm / 5 1/2"

SS-07-133
 17 cm / 6 1/4"

Olsen-Hegar

Gillies

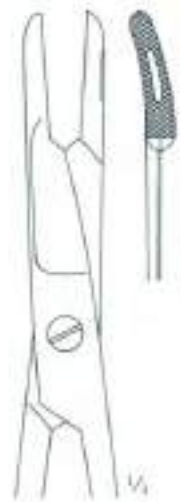

SS-07-134
 16 cm

Needle Holders
 Porta-agujas
 Porte-aiguilles



Crile



SS-07-135
 15 cm



Mathieu



SS-07-136
 14 cm



SS-07-137
 17 cm

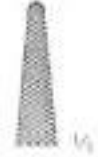

SS-07-138
 20 cm



Mathieu



SS-07-139
 14 cm



SS-07-140
 16.5 cm



Toennis



SS-07-141
 18.5 cm



Lichtenberg

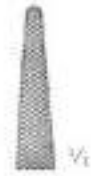

SS-07-142
 20 cm



Heamostatic Forceps 08

08 Hemostatics Forceps

Adson	111	Moynihan	137
Adson-Baby	118	Negus	133
Backhaus	139	Obwegeser	102
Bengolea	114	Organ Grasping Forceps	110
Bernhard	140	Orgen-Grasping	109
Bozemann	147,150	Overholt	122
Carfoord	119	Overholt-Baby	105
Chaput	109	Overholt-Fino	121
Cheron	147	Overholt-Geissendorfer	120
Collin	110,147	Overholt-Martin	117
Crile	104,105	Overholt-Mini	122
Crile-Rankin	101	Overholt-Mixer	118
Dandy	101	Peau	108,112
Dandy-Mosquito	101	Peau (Rochester)	115
Dasjardins	131	Peau-Nippon	113
Dissecting & Ligature Forceps	117,129,132	Peers-Bertram	141
Dressing Forceps	144-147	Peers-Bertram Modif	140
Faure	138	Pennington	110
Finochietto	128	Periosteal Elevators	102
Fletcher (Javerts)	150	Phaneuf	134
Foerster	148,149	Plaster Spreaders	130
Gemini	123	Pratt	110
Gross-Maier	146	Providence-Hospital	107
Guyon	130,131	Rampley	149
Halsted-Mosquito	103	Roberts	119
Hartmann	106	Rochester-Carmalt	111
Hemostatics Forceps	101,103-109,111-116	Roder	140
Heaney	134	Rogers	135
Heiss	118	Rowe	102
Hysterotomy Forceps	133-138	Rumel	121
Jones	139	Sarot	119
Jones-Martin	139	Schadel	139
Kelly	104,107,129	Schnidt	111
Kelly-Rankin	105	Spencer-Wells	108
Kidney Pedical Clamps	131	Spong Forceps	148-149
Kocher	112	Tiffier	109
Kicher- (Ochsner)	116	Tohoku	141
Kocher (Nippon)	113	Towel Clamp	139-141
Lahey	127	Tubing Clamp	142,143
Lane	141	Ulrich	144
Lawrence	132	Uro-Tangential	128
Leriche	107	Utrain Dressing Forceps	150
Lister	145	Wertheim	136,137
Lovelace	101	Wertheim-Cullen	133
Lower	127	Wickstrom	126
Martel-Rees	110	Zenker	124
Martin	145		
Martin-Fuchsig	111		
Mc Quigg-Mixer	127		
Meeker	132		
Mershon	102		
Mikro-Mosquito	103		
Mikulicz	136,138		
Mikulicz, Baby	136		
Mini-Gemini	123		
Mixer	125,126		
Mixer-Baby	106,118,124		
Mixer-o'Shaugnessy	125		

Haemostatic Forceps
Pinzas hemostáticas
Pincas hemostatiques

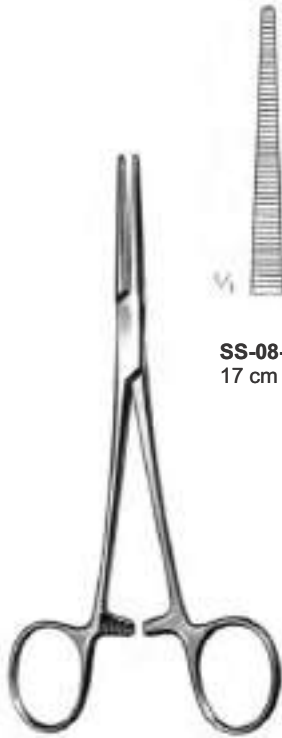

SS-08-101
17 cm / 6³/₄"



SS-08-102
17 cm / 6³/₄"



SS-08-103
17 cm / 6³/₄"



SS-08-104
17 cm / 6³/₄"

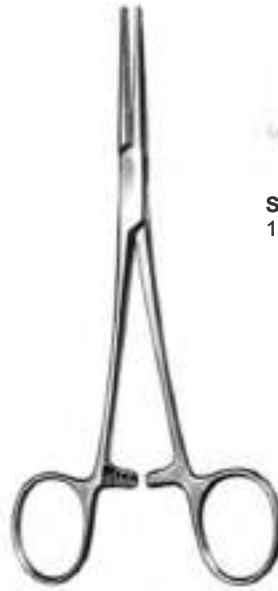

Lovelace



SS-08-105
12 cm / 4³/₄"
Laterally curved
curva lateralmente
courbe lateralment

Dandy-Mosquito



Dandy



SS-08-106
14.5 cm / 5³/₄"
Laterally curved
Curva lateralmente
courbe lateralement

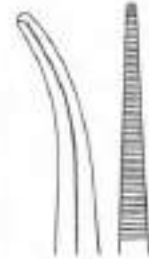













SS-08-107
14.5 cm / 5³/₄"
Laterally curved
Curva lateralmente
courbe lateralement











Haemostatic Forceps
 Pinzas hemostáticas
 Pincas hemostatiques



			
SS-08-108 12.5 cm / 5"	SS-08-109 14.5 cm / 5¾"	SS-08-110 12 cm / 4¾"	SS-08-111 14 cm / 5½"
			
SS-08-112 12.5 cm / 5"	SS-08-113 14.5 cm / 5¾"	SS-08-114 12 cm / 4¾"	SS-08-115 14 cm / 5½"
			

Halsted-Mosquito



			
SS-08-116 12.5 cm / 5"	SS-08-117 12 cm / 4¾"	SS-08-118 12 cm / 4¾"	SS-08-119 12 cm / 4¾"
			

Halsted-Mosquito

Haemostatic Forceps
Pinzas hemostáticas
Pincas hemostatiques



Halsted-Mosquito



SS-08-120
18.5 cm / 7¼"



SS-08-121
18 cm / 7"



SS-08-122
18.5 cm / 7¼"



SS-08-123
18 cm / 7"



1:2



1:2

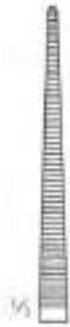

SS-08-124
21 cm / 8¼"



SS-08-125
20.5 cm / 8"



SS-08-126
21 cm / 8¼"



SS-08-127
20.5 cm / 8"



1:2



1:2



Mikro-Mosquito



SS-08-128
10 cm / 4"



SS-08-129
12 cm / 4¾"



SS-08-130
9.5 cm / 3¾"



SS-08-131
11.5 cm / 4½"



SS-08-132
10 cm / 4"



SS-08-133
12 cm / 4¾"



SS-08-134
10 cm / 4"



SS-08-135
12 cm / 4¾"



1:2



1:2



1:2



1:2



SAPTESTAR
Manufacturer & Exporter Of Surgical, Dental & Veterinary Instruments

Haemostatic Forceps
Pinzas hemostáticas
Pinces hemostatiques



Kelly

- SS-08-500 16 cm / 6 1/4"
- SS-08-501 18 cm / 7"
- SS-08-502 20 cm / 8"
- SS-08-503 23 cm / 9"
- SS-08-504 25 cm / 10"



- SS-08-510 16 cm / 6 1/4"
- SS-08-511 18 cm / 7"
- SS-08-512 20 cm / 8"
- SS-08-513 23 cm / 9"
- SS-08-514 25 cm / 10"

- SS-08-520 16 cm / 6 1/4"
- SS-08-521 18 cm / 7"
- SS-08-522 20 cm / 8"
- SS-08-523 23 cm / 9"
- SS-08-524 25 cm / 10"



Kelly

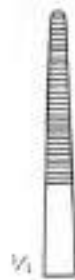

- SS-08-136
14.5 cm / 5 3/4"



- SS-08-137
14 cm / 5 1/2"



Crile



- SS-08-138
14.5 cm / 5 3/4"



- SS-08-139
14 cm / 5 1/2"

Haemostatic Forceps
Pinzas hemostáticas
Pinces hemostatiques



½ Kelly-Rankin



SS-08-140
16 cm / 6¼"



SS-08-141
15.5 cm / 6"



½ Overholt-Baby



SS-08-142
14 cm / 5½"



½ Crile

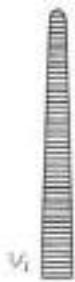

SS-08-143
14.5 cm / 5¾"



SS-08-144
14 cm / 5½"



SS-08-145
20.5 cm / 8"



SS-08-146
20.5 cm / 8"



1:2



1:2

Haemostatic Forceps
 Pinzas hemostáticas
 Pincers hemostatiques

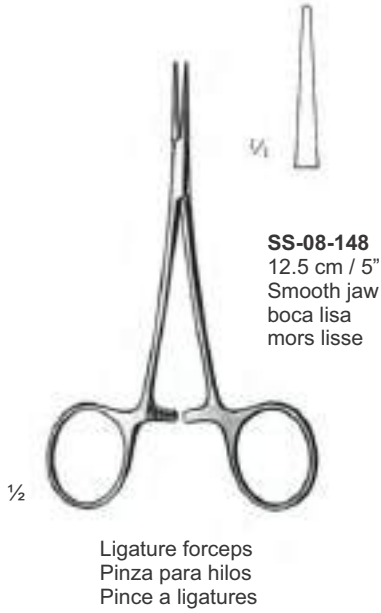

Haemostatic Forceps
Pinzas hemostáticas
Pincas hemostatiques



1/2

Providence-Hospital



SS-08-154
14 cm / 5 1/2"



SS-08-155
14 cm / 5 1/2"



1/2

Leriche



SS-08-156
15.5 cm / 6"



SS-08-157
15 cm / 6"



SS-08-158
15.5 cm / 6"



SS-08-159
15 cm / 6"

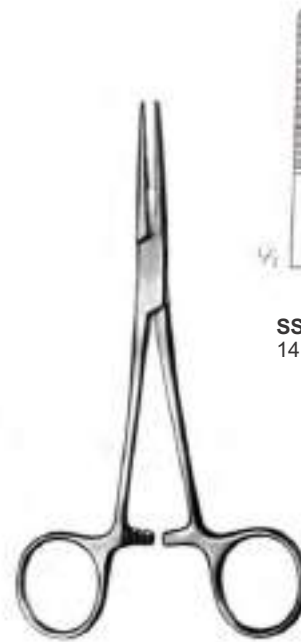

1/2

Kelly



SS-08-160
14.5 cm / 5 3/4"



SS-08-161
14 cm / 5 1/2"



SAPTESTAR
Manufacturer & Exporter Of Surgical, Dental & Veterinary Instruments

Haemostatic Forceps
Pinzas hemostaticas
Pinces hemostatiques



1/2

Pean



SS-08-162
14.5 cm / 5 3/4"



SS-08-163
16 cm / 6 1/4"

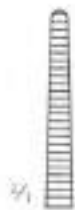

SS-08-164
13 cm / 5"



SS-08-165
14 cm / 5 1/2"



SS-08-166
15.5 cm / 6"



SS-08-167
18.5 cm / 7 1/4"

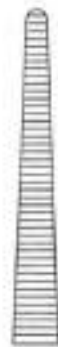

SS-08-168
20 cm / 8"



SS-08-169
13 cm / 5"



SS-08-170
14 cm / 5 1/2"



SS-08-171
15 cm / 6"



SS-08-172
18 cm / 7"



SS-08-173
20 cm / 8"



1/2

Spencer-Wells

Haemostatic Forceps
Pinzas hemostaticas
Pincers hemostatiques

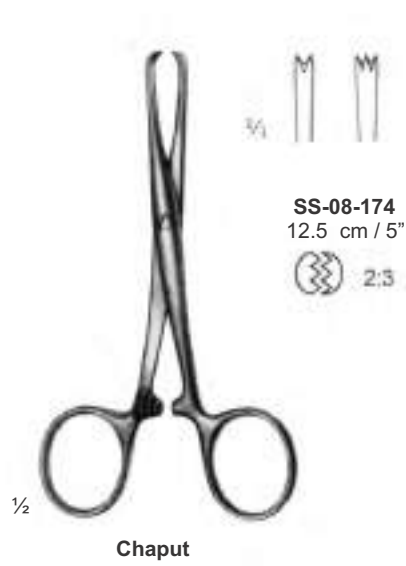

Atrauma



Organ-Grasping



SAPTESTAR
Manufacturer & Exporter Of Surgical, Dental & Veterinary Instruments

Organ Grasping Forceps
Pinzas para sacar organ
Pinces pour saisir des organes



SS-08-178
14 cm / 5½"

Collin



SS-08-179
17 cm / 6¾"

Collin

Tumor grasping forceps
Pinzas para sacar organ
Pinces a tumeurs avis



SS-08-180
15.5 cm / 6"

SS-08-181
21 cm / 8¼"

Bennington



SS-08-182
15 cm / 6"

Pratt



SS-08-183
13.5 cm / 5¼"

Martel-Rees

Face lift forceps
Pinza para Face-Lift
Pinces pour Face-lift

Haemostatic Forceps
Pinzas hemostaticas
Pinces hemostatiques



Schnidt

SS-08-184
18,5 cm / 7¼"



SS-08-185
19 cm / 7½"



Adson

SS-08-186
19 cm / 7½"



SS-08-187
18.5 cm / 7¼"

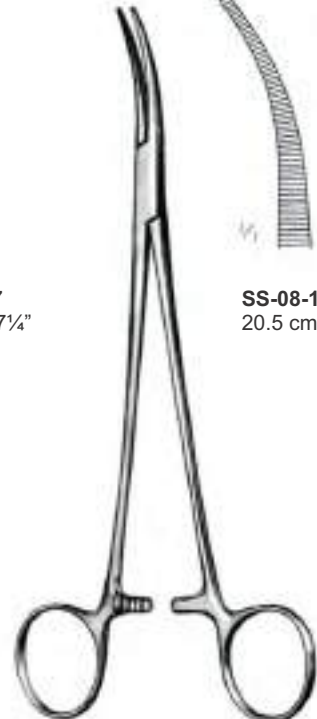

Martin-Fuchsig

SS-08-188
20.5 cm / 8"



Rochester-Carmalt



SS-08-189
17 cm / 6¾"



SS-08-190
20.5 cm / 8"



SS-08-191
16.5 cm / 6½"



SS-08-192
20 cm / 8"

Haemostatic Forceps
 Pinzas hemostaticas
 Pincas hemostatiques

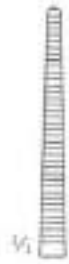

SS-08-193
 13.5 cm / 5¼"



SS-08-194
 14.5 cm / 5¾"



SS-08-195
 17 cm / 6¾"



SS-08-196
 13 cm / 5"



SS-08-197
 14 cm / 5½"



SS-08-198
 16.5 cm / 6½"

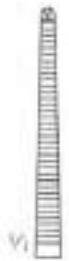

SS-08-199
 13 cm / 5"



SS-08-200
 14 cm / 5½"



SS-08-201
 16 cm / 6¼"



SS-08-202
 13 cm / 5"



SS-08-203
 14 cm / 5½"



SS-08-204
 16 cm / 6¼"



Haemostatic Forceps
Pinzas hemostaticas
Pincas hemostatiques



Pean-Nippon

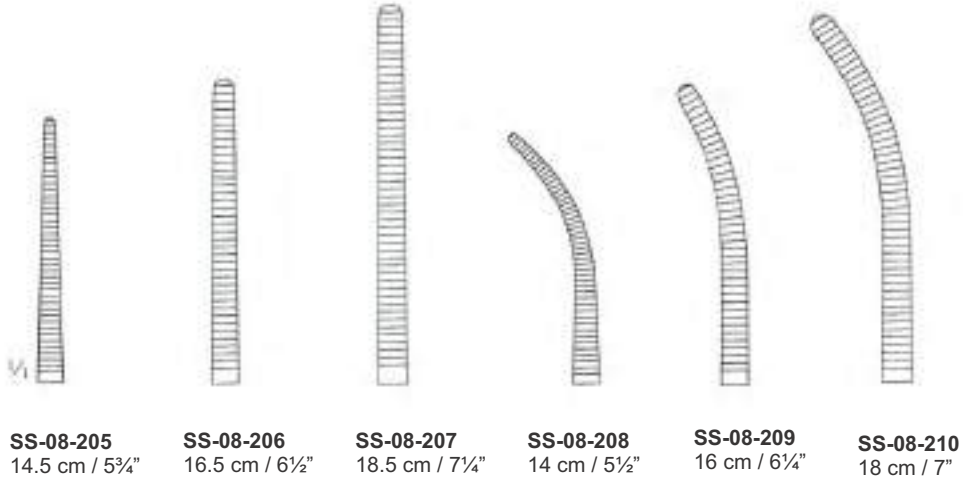

Kocher-Nippon

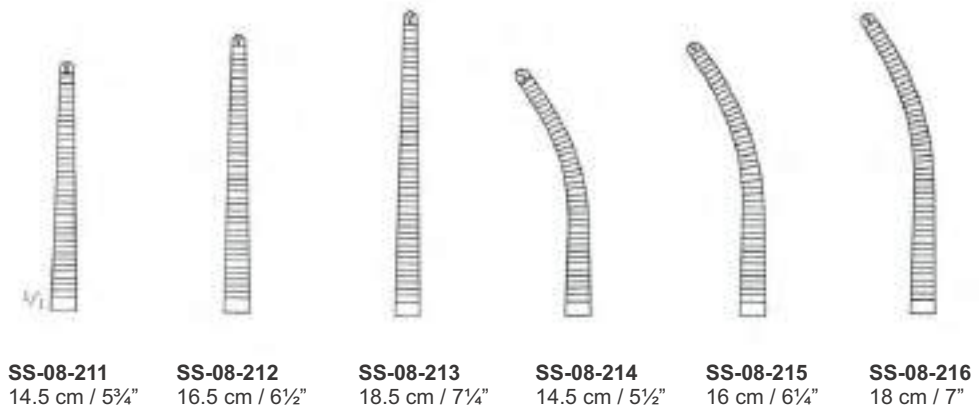

1/2



Haemostatic Forceps
 Pinzas hemostaticas
 Pincas hemostatiques



SS-08-217
 21.5 cm / 8½"



SS-08-218
 21 cm / 8¼"



SS-08-219
 21.5 cm / 8½"



SS-08-220
 21 cm / 8¼"



Bengolea



SS-08-221
 26 cm / 10¼"



SS-08-222
 25.5 cm / 10"



SS-08-223
 26 cm / 10¼"



SS-08-224
 25.5 cm / 10"



Haemostatic Forceps
Pinzas hemostaticas
Pincers hemostatiques

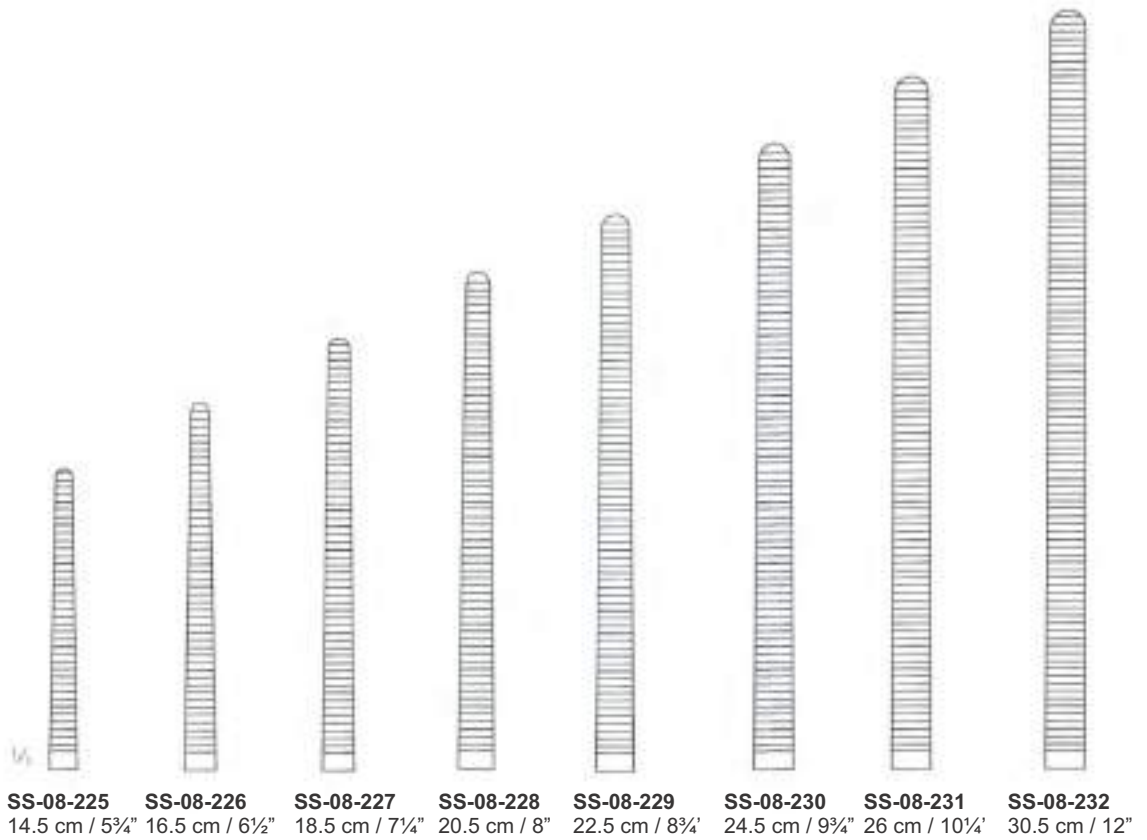

Pean (Rochester)

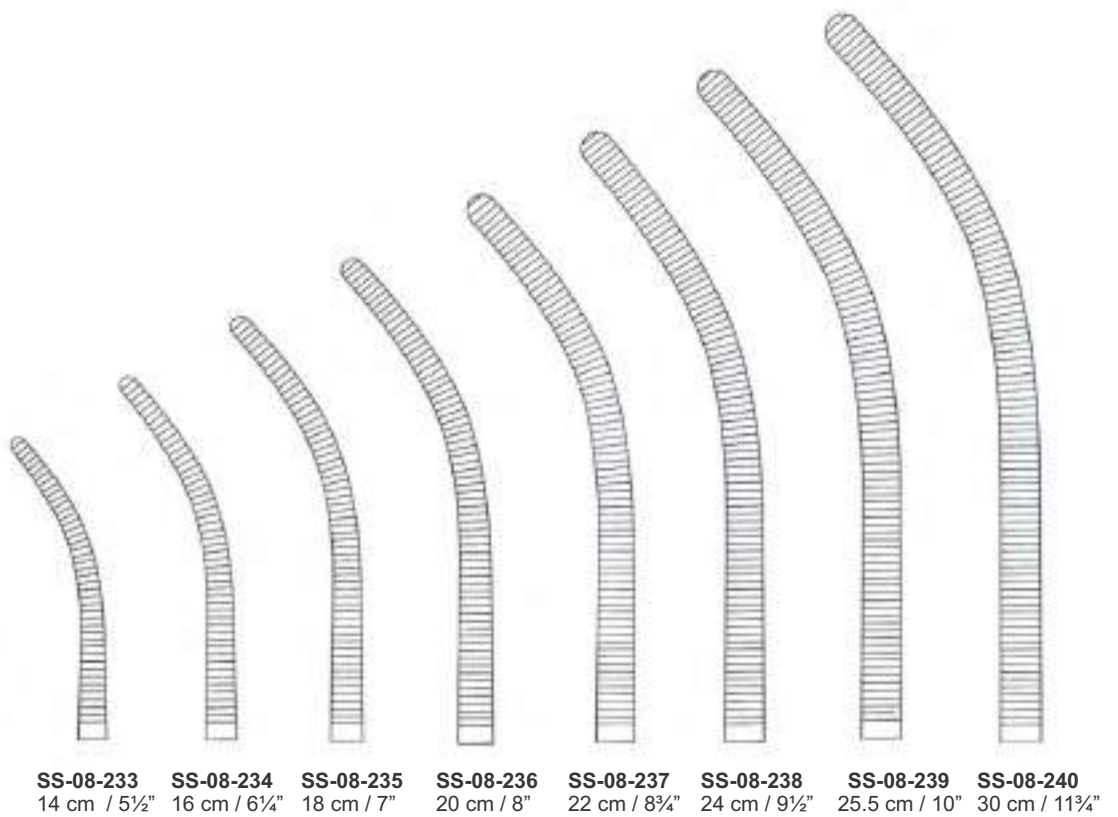



SAPTESTAR
Manufacturer & Exporter Of Surgical, Dental & Veterinary Instruments

Haemostatic Forceps
Pinzas hemostaticas
Pinces hemostatiques

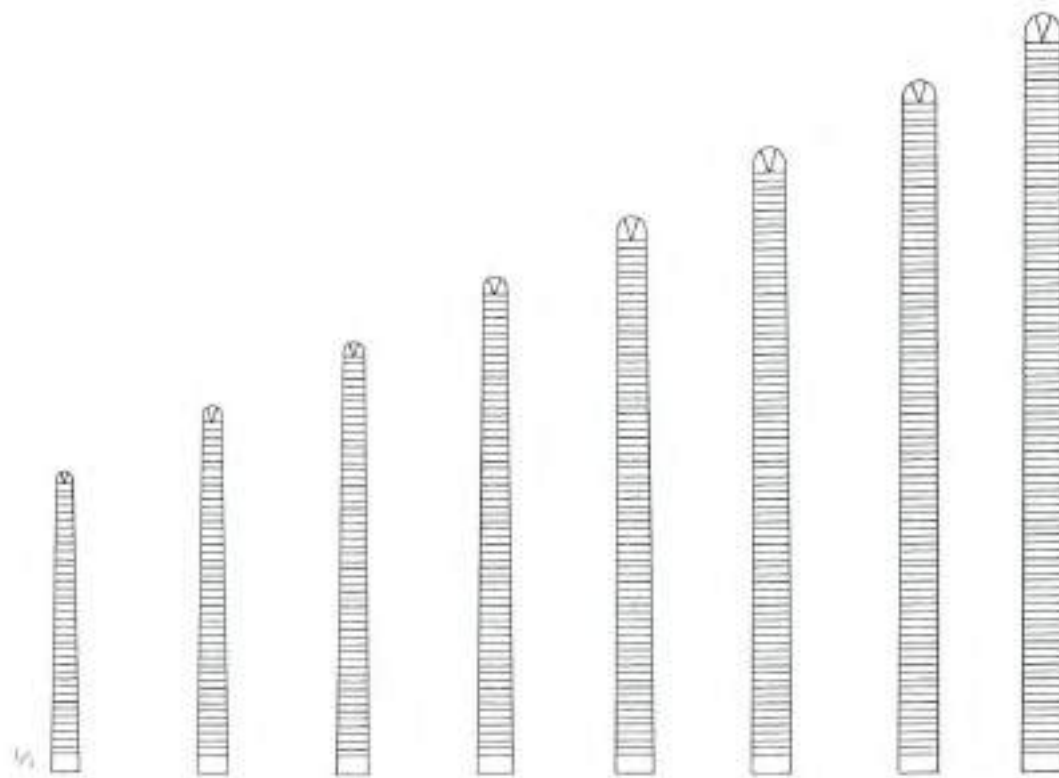

SS-08-241 14.5 cm / 5¾"	SS-08-242 16.5 cm / 6½"	SS-08-243 18.5 cm / 7¼"	SS-08-244 20.5 cm / 8"	SS-08-245 22.5 cm / 8¾"	SS-08-246 24.5 cm / 9¾"	SS-08-247 26 cm / 10¼"	SS-08-248 30.5 cm / 12"
-----------------------------------	-----------------------------------	-----------------------------------	----------------------------------	-----------------------------------	-----------------------------------	----------------------------------	-----------------------------------



Kocher (Ochsner)



1:2

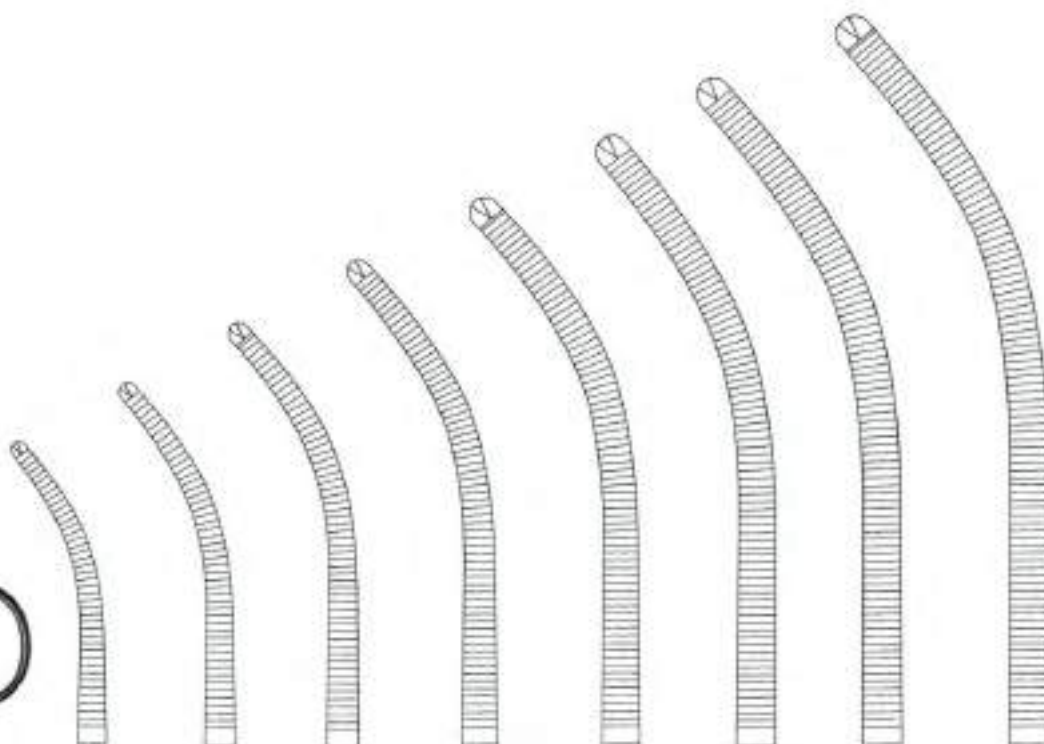

SS-08-249 14 cm / 5½"	SS-08-250 16 cm / 6¼"	SS-08-251 18 cm / 7"	SS-08-252 20 cm / 8"	SS-08-253 22 cm / 8¾"	SS-08-254 24 cm / 9½"	SS-08-255 25.5 cm / 10"	SS-08-256 30 cm / 11¾"
---------------------------------	---------------------------------	--------------------------------	--------------------------------	---------------------------------	---------------------------------	-----------------------------------	----------------------------------



Overholt-Martin

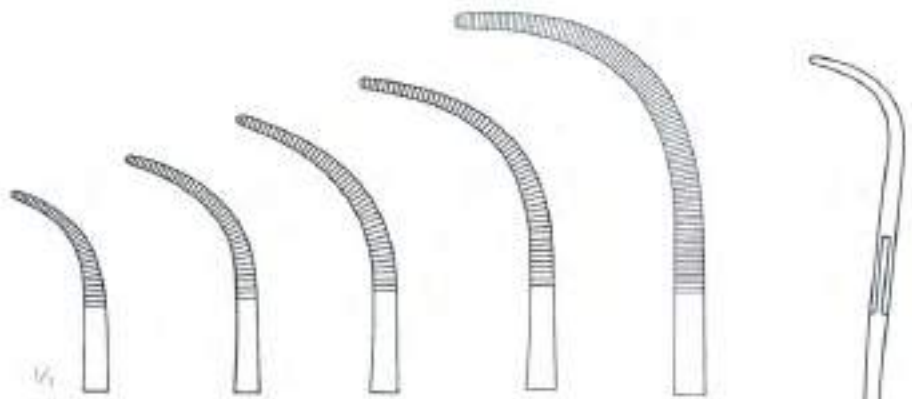

SS-08-257
18.5 cm / 7¼"
Fig. 1

SS-08-258
20.5 cm / 8"
Fig. 2

SS-08-259
21 cm / 8¼"
Fig. 3

SS-08-260
21.5 cm / 8½"
Fig. 4

SS-08-261
24.5 cm / 9¾"
Fig. 5

Dissecting and Ligature Forceps
 Pinzas para preparación y ligadura
 Pinces per preparazioni e legature



SS-08-262
 18.5 cm / 7 $\frac{1}{4}$ "

Mixer-Baby



SS-08-263
 14.5 cm / 5 $\frac{3}{4}$ "



SS-08-264
 18 cm / 7"

Adson-Baby



SS-08-265
 21 cm / 8 $\frac{1}{4}$ "

Heiss



SS-08-266
 20.5 cm / 8"



SS-08-267
 20 cm / 8"



SS-08-268
 21.5 cm / 8 $\frac{1}{2}$ "

Overholt-Mixer





SAPTESTAR
Manufacturer & Exporter Of Surgical, Dental & Veterinary Instruments

Dissecting and Ligature Forceps
Pinzas para preparación y ligadura
Pinces per preparazioni e legature

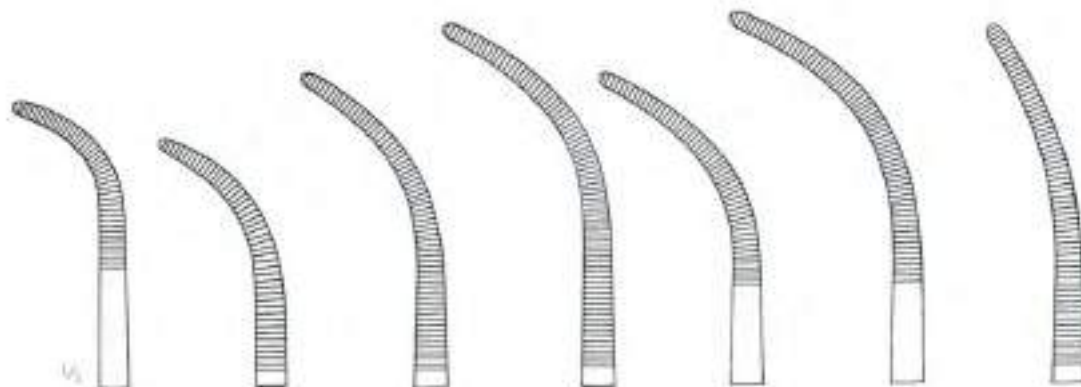

SS-08-275
20.5 cm / 8"
Fig. 1

SS-08-276
20 cm / 8"
Fig. 2

SS-08-277
21.5 cm / 8½"
Fig. 3

SS-08-278
22 cm / 8¾"
Fig. 4

SS-08-279
21.5 cm / 8½"
Fig.5

SS-08-280
22 cm / 8¾"
Fig. 6

SS-08-281
22 cm / 8¾"
Fig. 7



SS-08-282
27 cm / 10¾"
Fig. 1

SS-08-283
26.5 cm / 10½"
Fig. 2

SS-08-284
27.5 cm / 10¾"
Fig. 3

SS-08-285
28 cm / 11"
Fig. 4

SS-08-286
27.5 cm / 10¾"
Fig. 5

SS-08-287
28 cm / 11"
Fig. 6

SS-08-288
27.5 cm / 10¾"
Fig. 7



Overholt-Geissendorfer

Dissecting and Ligature Forceps
Pinzas para preparación y ligadura
Pinces per preparazioni e legature



Overholt-Fino



SS-08-289
21.5 cm / 8½"



SS-08-290
21 cm / 8½"



SS-08-291
22 cm / 8½"



SS-08-292
23 cm / 9"



SS-08-293
22.5 cm / 8¾"



Rumel



SS-08-294
24 cm / 9½"



SS-08-295
23.5 cm / 9¼"



SS-08-296
23 cm / 9"



SS-08-297
24 cm / 9½"



SS-08-298
23.5 cm / 9¼"

Dissecting and Ligature Forceps
 Pinzas para preparación y ligadura
 Pincas per preparazioni e legature

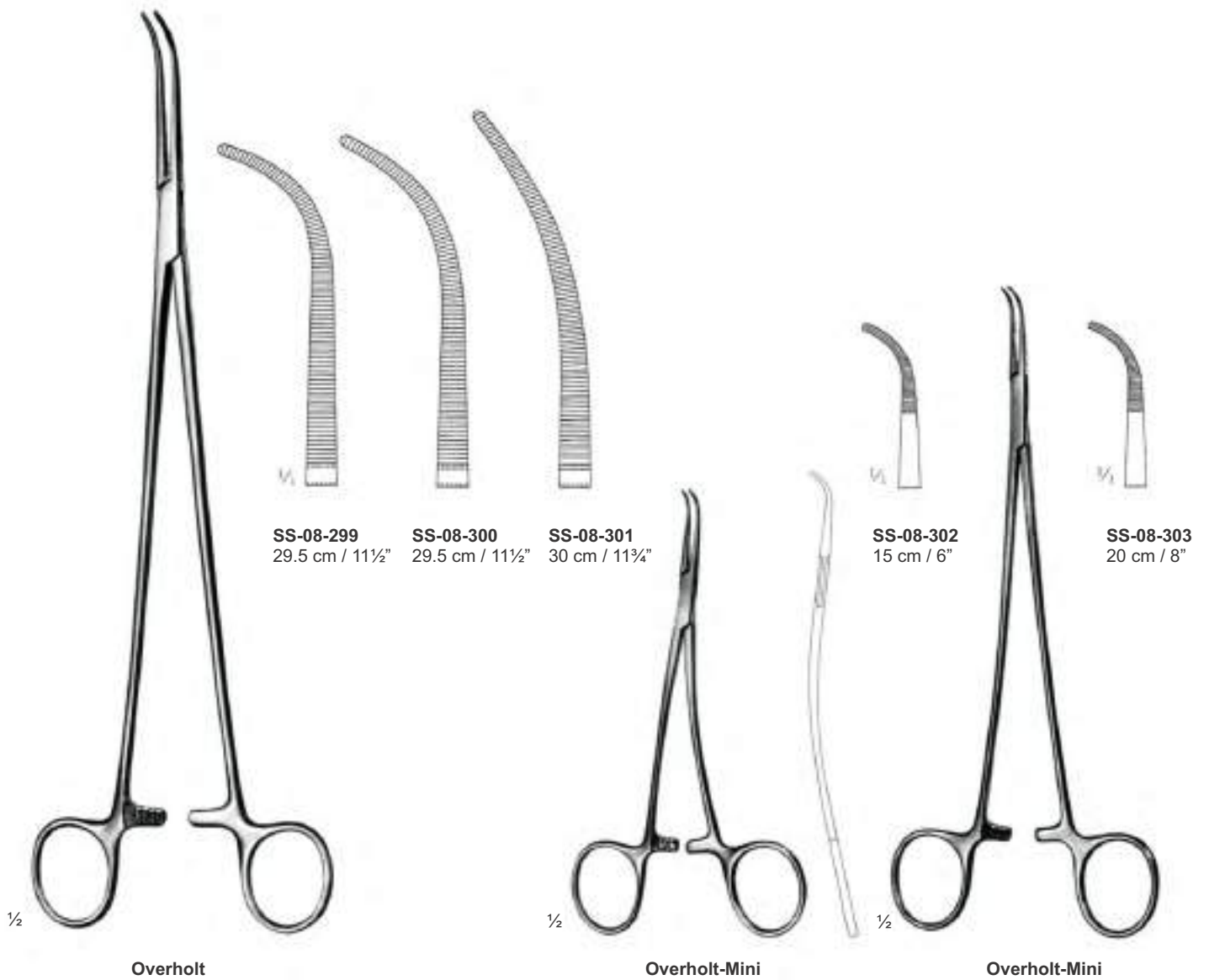

Dissecting and Ligature Forceps
Pinzas para preparación y ligadura
Pincers para preparazioni e legature



Mini-Gemini

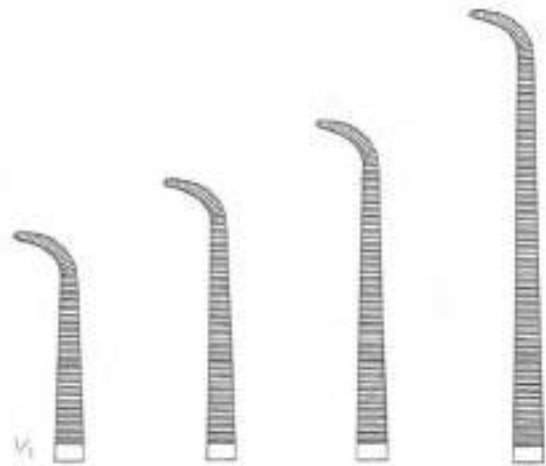

SS-08-304
18 cm / 7"

SS-08-305
22.5 cm / 8¾"

SS-08-306
25 cm / 9¾"

SS-08-307
28.5 cm / 11¼"



Gemini



SS-08-308
13 cm / 5"

SS-08-309
16 cm / 6¼"

SS-08-310
18 cm / 7"

SS-08-311
21 cm / 8¼"

SS-08-312
23cm / 9"

SS-08-313
25 cm / 9¾"

SS-08-314
28 cm / 11"

Dissecting and Ligature Forceps
Pinzas para preparación y ligadura
Pinces per preparazioni e legature



Zenker

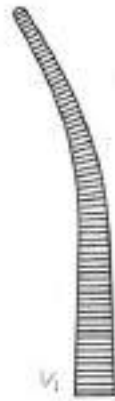

SS-08-315
29.5 cm / 11½"



SS-08-316
28.5 cm / 11¼"



Mixer-Baby



SS-08-317
13.5 cm / 5¼"

Dissecting and Ligature Forceps
Pinzas para preparación y ligadura
Pinces per preparazioni e legature



1/2

Mixer



SS-08-318
16 cm / 6 1/4"

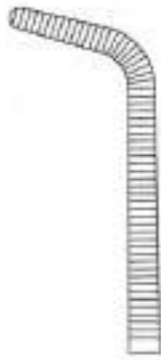

SS-08-319
18 cm / 7"



1/2

Mixer-O'Shaugnessy



SS-08-320
18 cm / 7"



1/2

Mixer

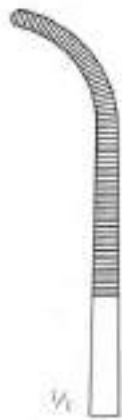

SS-08-321
22.5 cm / 8 3/4"



1/2

Mixer



SS-08-322
23 cm / 9"

Dissecting and Ligature Forceps
Pinzas para preparación y ligadura
Pinces per preparazioni e legature



Dissecting and Ligature Forceps
Pinzas para preparación y ligadura
Pinces per preparazioni e legature



SS-08-328
23.5 cm / 9¼"

Mc Quigg-Mixer



SS-08-329
18.5 cm / 7¼"

Lower



SS-08-330
19.5 cm / 7¾"

SS-08-331
22.5 cm / 8¾"

Lahey

Dissecting and Ligature Forceps
Pinzas para preparación y ligadura
Pinces per preparazioni e legature



SS-08-332
24 cm / 9½"

Finochietto



SS-08-333
25 cm / 9¾"
Fig. 1

SS-08-334
27 cm / 10¾"
Fig. 2

Uro-Tangential

Dissecting and Ligature Forceps
Pinzas para preparación y ligadura
Pince per preparazioni e legature

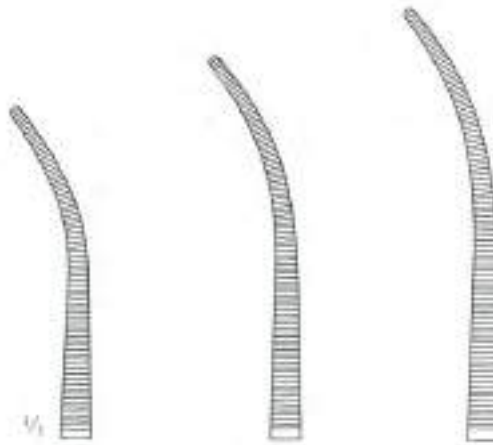

SS-08-335
19.5 cm / 7¾"
Fig. 1

SS-08-336
22.5 cm / 8¾"
Fig. 1

SS-08-337
24.5 cm / 9¾"
Fig. 1

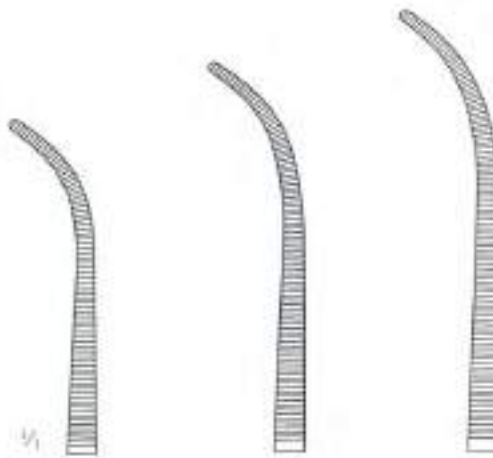

SS-08-338
19 cm / 7½"
Fig. 2

SS-08-339
22 cm / 8¾"
Fig. 2

SS-08-340
24cm / 9½"
Fig. 2



Kelly

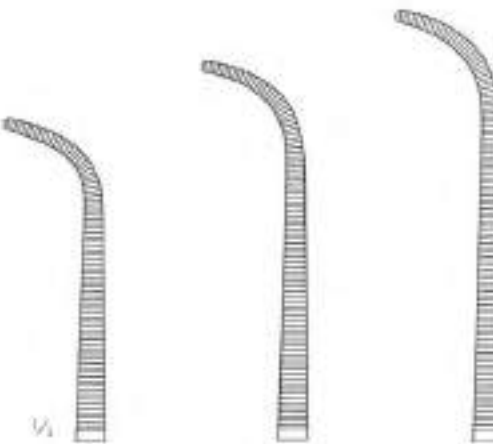

SS-08-341
18.5 cm / 7¼"
Fig.3

SS-08-342
21.5 cm / 8½"
Fig. 3

SS-08-343
23.5 cm / 9¼"
Fig. 3

Plaster Spreaders
Separadores para escayolas
Pinces ecartantes a platre



SS-08-344
23 cm / 9"



SS-08-345
24 cm / 9½"



SS-08-346
24 cm / 9½"

Guyon

Guyon

Kidney Pedicle Clamps
 Pinzas para pediculo renal
 Pinces-clamps pour pedicules renaux



½

Guyon



SS-08-347
 19.5 cm / 7¾"



SS-08-348
 21.5 cm / 8½"



SS-08-349
 24 cm / 9½"



½

Desjardins



SS-08-350
 21 cm / 8¼"

Dissecting and Ligature Forceps
Pinzas para preparación y ligadura
Pinces per preparazioni e legature



Haemostatic Forceps
Pinzas hemostaticas
Pinces hemostatiques



Wertheim-Cullen

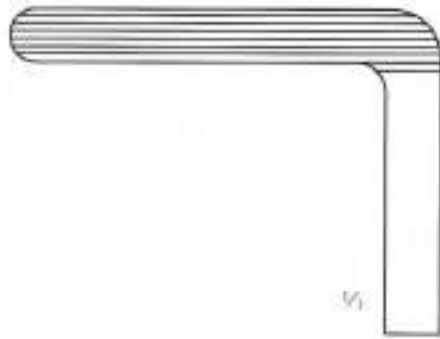

SS-08-353
21 cm / 8¼"



Negus



SS-08-354
19.5 cm / 7¾"
Fig. 1



SS-08-355
20 cm / 8"
Fig. 2



SAPTESTAR
Manufacturer & Exporter Of Surgical, Dental & Veterinary Instruments

Hysterectomy Forceps
Pinzas para histerectomía
Pincas a hysterectomie



Phaneuf



SS-08-356
20.5 cm / 8"



SS-08-357
20 cm / 8"

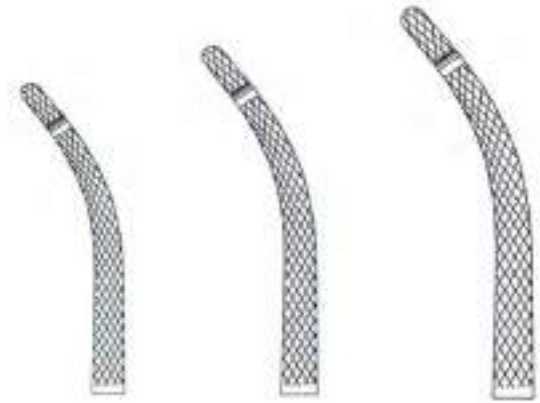

SS-08-358
19.5 cm / 7¾"
Fig.1

SS-08-359
21.5 cm / 8½"
Fig. 1

SS-08-360
24 cm / 9½"
Fig. 1



Heaney

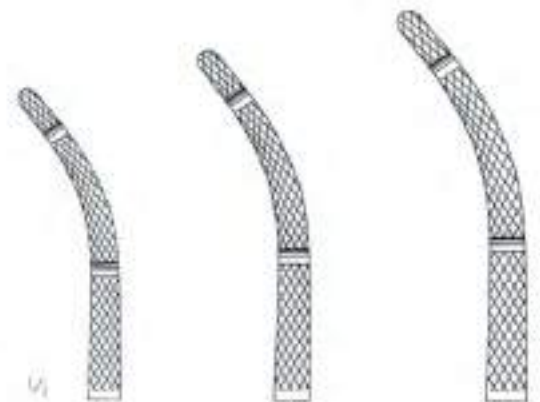

SS-08-361
19.5 cm / 7¾"
Fig. 2

SS-08-362
21.5 cm / 8½"
Fig. 2

SS-08-363
24 cm / 9½"
Fig. 2

Hysterectomy Forceps
Pinzas para histerectomía
Pincas a histerectomie



Rogers



SS-08-364
21.5 cm / 8½"
Fig. 1



SS-08-365
21 cm / 8¼"
Fig. 2



SS-08-366
20.5 cm / 8"
Fig. 3



SS-08-367
20 cm / 8"
Fig. 4



SS-08-368
25.5 cm / 10"
Fig. 1



SS-08-369
25 cm / 9¾"
Fig. 2



SS-08-370
24.5 cm / 9¾"
Fig. 3



SAPTESTAR
Manufacturer & Exporter Of Surgical, Dental & Veterinary Instruments

Hysterectomy Forceps
Pinzas para histerectomía
Pinces a hysterectomie



Wertheim



SS-08-371
22.5 cm / 8 3/4"



Slightly curved
curva ligera
courbe legere



SS-08-372
22.5 cm / 8 3/4"



More curved
curve fuerte
courbe forte



Mikulicz, Baby



SS-08-373
14.5 cm / 5 3/4"



Mikulicz



SS-08-374
18.5 cm / 7 1/4"



Mikulicz



SS-08-375
20 cm / 8"



Hysterectomy Forceps
 Pinzas para histerectomía
 Pincas a hysterectomie



SS-08-376
 23 cm / 9"

Moynihan



SS-08-377
 23.5 cm / 9 1/4"

Moynihan



SS-08-378
 26 cm / 10 1/4"

Wertheim

Hysterectomy Forceps
 Pinzas para histerectomía
 Pincas a hysterectomie



Towel Clamps
Pinzas de campo
Pinces a champs



Schädel
SS-08-383
9 cm / 3½"
sharp
aguda
aigue



Jones
sharp
aguda
aigue

SS-08-384
5.5 cm / 2¼"

SS-08-385
8.5 cm / 3¼"



Jones-Martin
SS-08-386
8.5 cm / 3¼"
sharp
aguda
aigue

With tube holder
con porta-tubo
avec clamp porte-tube



SS-08-390
9 cm / 3½"

SS-08-391
5.5 cm / 2¼"

SS-08-392
13 cm / 5"

SS-08-393
16 cm / 6¼"



SS-08-387
11.5 cm / 4½"

SS-08-388
13 cm / 5"

Backhaus
Delicate model
modelo delicado
modele gracile



With tube holder
con porta-tubo
avec clamp porte-tube

Backhaus
SS-08-389
11.5 cm / 4½"



Backhaus

Towel Clamps
 Pinzas de campo
 Pinces a champs

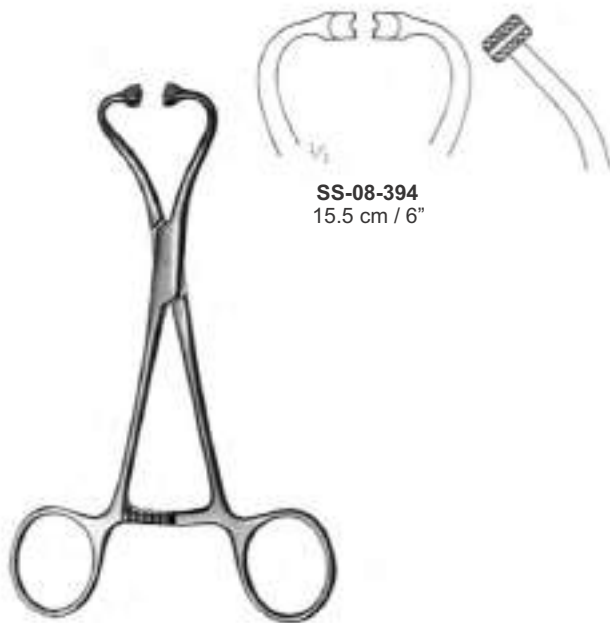

SS-08-394
 15.5 cm / 6"

½ **Peers-Bertram modif.**
 Wide jaw for tube fixation
 boca ancha para fijacion de tubos
 more large pour fixation de tube



½ **Röder**
SS-08-395
 13.5 cm / 5¼"

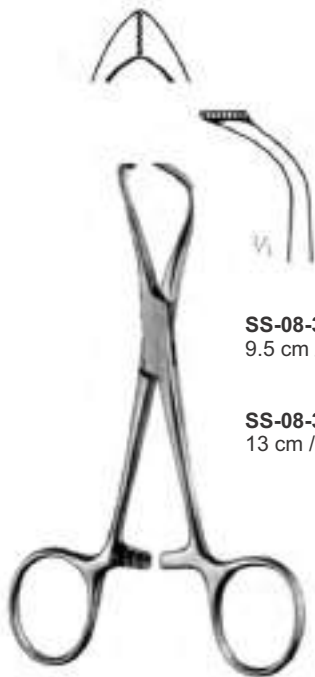

SS-08-396
 9.5 cm / 3¾"

SS-08-397
 13 cm / 5"

½ **Fine serrated wide jaw**
 boca ancha, delicadamente dentada
 mors large avec dents fins



½ **Bernhard**
SS-08-398
 16.5 cm / 6½"

Towel Clamps
 Pinzas de campo
 Pinces a champs



SS-08-399
 10.5 cm / 4"

SS-08-400
 13.5 cm / 5¼"

½

Tohoku
 Blunt
 roma
 moussee

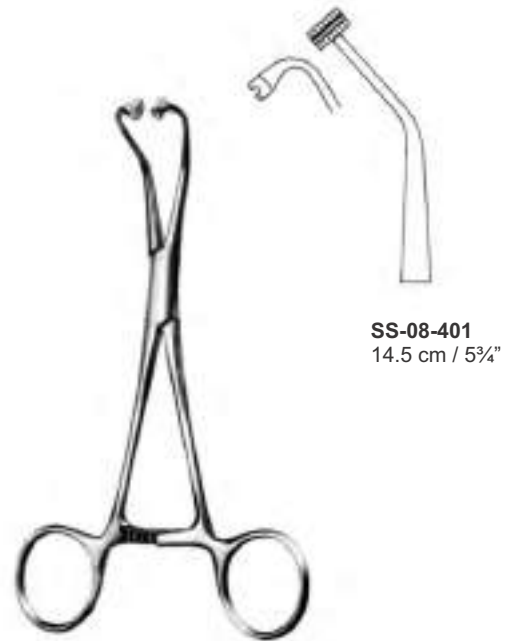

SS-08-401
 14.5 cm / 5¾"

Peers-Bertram

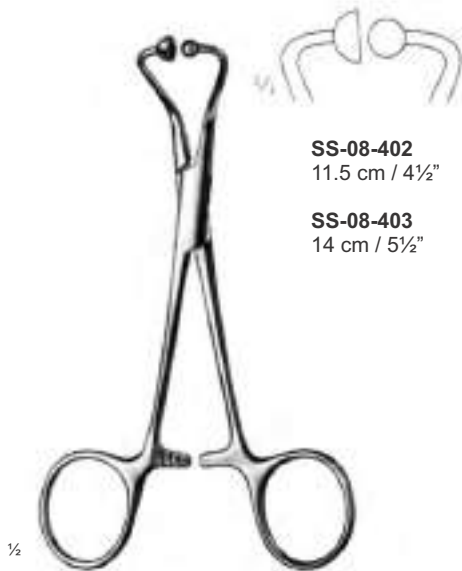

SS-08-402
 11.5 cm / 4½"

SS-08-403
 14 cm / 5½"

½

For paper clothes
 para panos de papel
 pour couverture en papier



SS-08-404
 19.5 cm / 7¾"

½

Lane

Tubing Clamps
Pinzas para tubos
Pinces presse-tubes

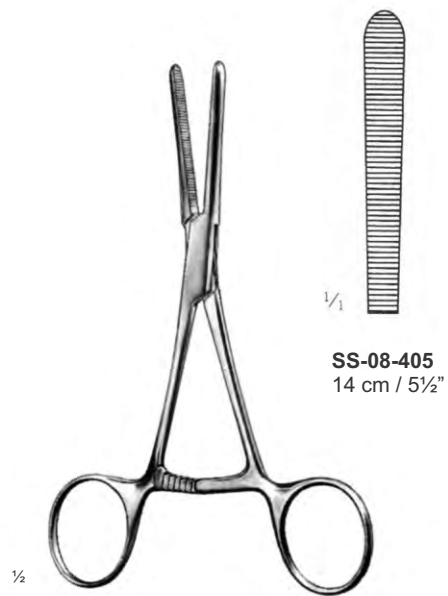

SS-08-405
14 cm / 5½"

Extra long ratchet
cremallera extra larga
cremaillere extremement longue



SS-08-406
16.5 cm / 6½"

Tubing Clamps
Pinzas para tubos
Pinces presse-tubes



1/2



SS-08-407
15.5 cm / 6"



SS-08-408
19 cm / 7 1/2"



SS-08-409
20.5 cm / 8"



1/2



SS-08-410
15.5 cm / 6"



SS-08-411
19 cm / 7 1/2"



SS-08-412
20.5 cm / 8"

With Safety guard
con estribo de proteccion
avec protection



SAPTESTAR
Manufacturer & Exporter Of Surgical, Dental & Veterinary Instruments

Dressing Forceps
Pinzas para tapones
Pinces a tampons



SS-08-413
22.5 cm / 8¾"

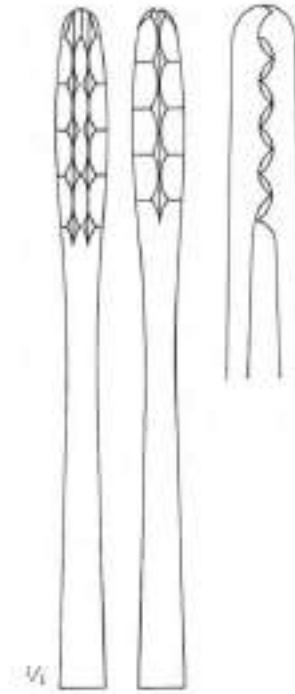

SS-08-414
26.5 cm / 10½"



Ulrich



SS-08-415
22.5 cm / 8¾"

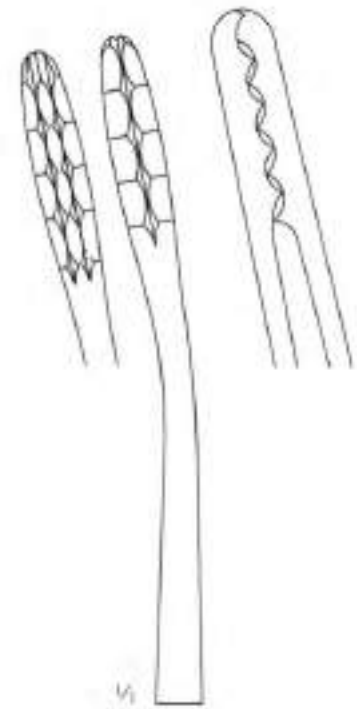

SS-08-416
26.5 cm / 10½"

Dressing Forceps
 Pinzas para tapones
 Pincas a tampons



1/2

Lister



1/2

SS-08-417
 13 cm / 5"



SS-08-418
 16 cm / 6 1/4"



SS-08-419
 18 cm / 7"



1/2

Martin



1/2

SS-08-420
 17.5 cm / 7"



SS-08-421
 17 cm / 6 3/4"

Dressing Forceps
Pinzas para tapones
Pincas a tampons



Gross-Maier



SS-08-422
20.5 cm / 8"

SS-08-424
22 cm / 8 3/4"

SS-08-426
26.5 cm / 10 1/2"



SS-08-423
20 cm / 8"

SS-08-425
21.5 cm / 8 1/2"

SS-08-427
25 cm / 10 1/4"

Dressing Forceps
 Pinzas para tapones
 Pincas a tampons

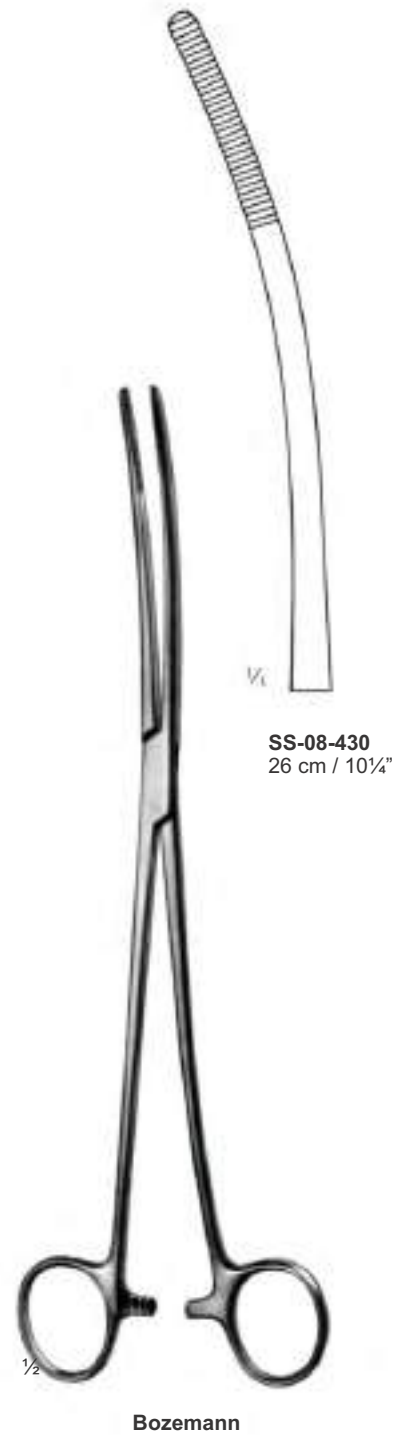

Sponge Forceps
 Pinzas para tapones
 Pincas a eponges



1/2

Foerster



3/4

SS-08-431
 25 cm / 9 3/4"
 Smooth jaw
 boca lisa
 mors lisse



SS-08-432
 18 cm / 7"

SS-08-433
 20.5 cm / 8"

SS-08-434
 25 cm / 9 3/4"

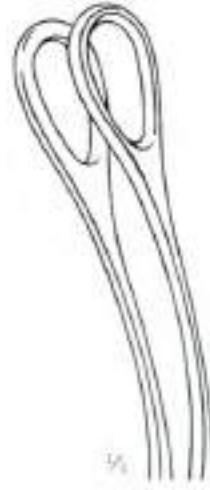

3/4

SS-08-435
 24.5 cm / 9 3/4"
 Smooth jaw
 boca lisa
 mors lisse



SS-08-436
 17.5 cm / 7"

SS-08-437
 20 cm / 8"

SS-08-438
 24.5 cm / 9 3/4"

Sponge Forceps
Pinzas para tapones
Pinces pour eponges

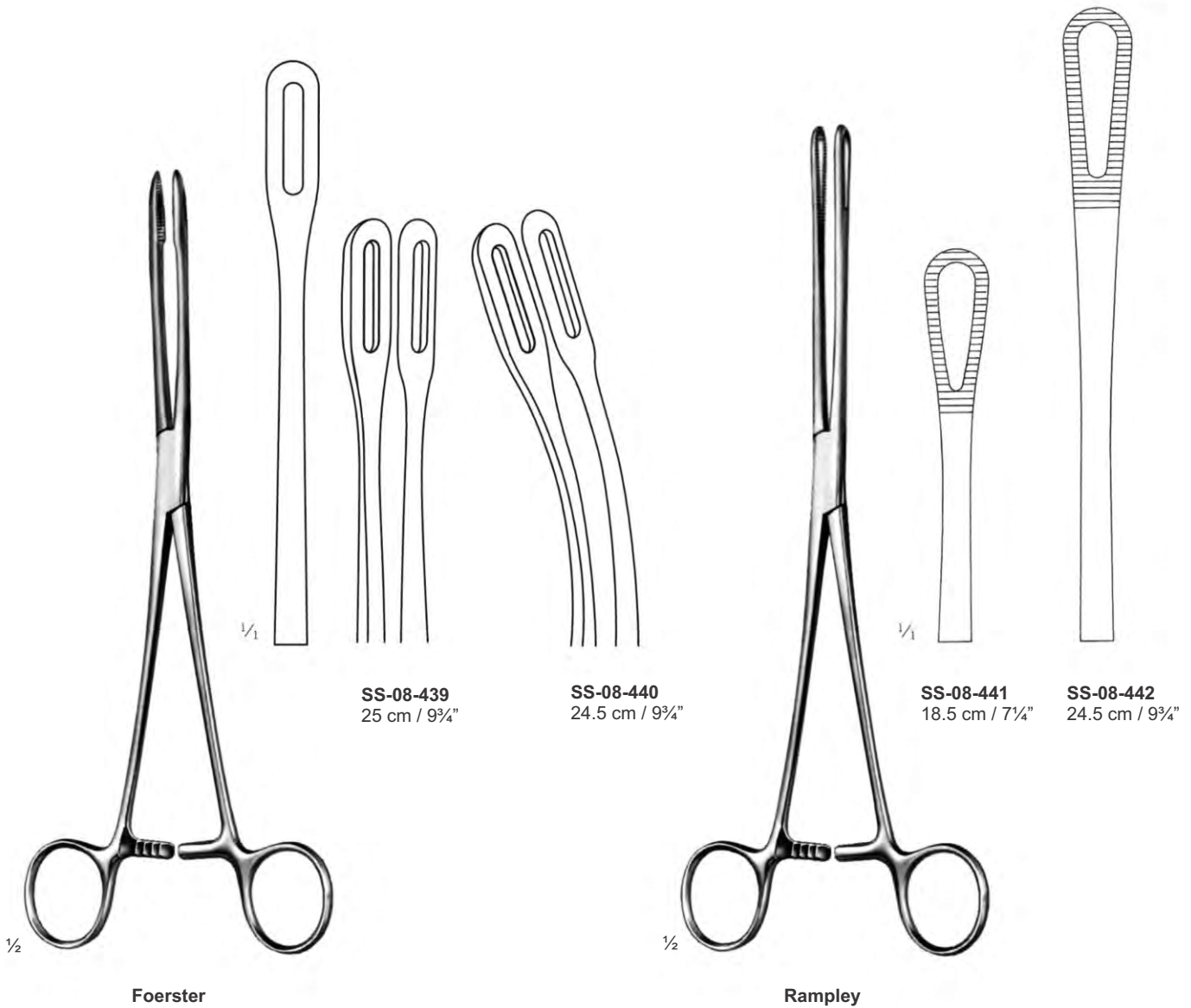

Utrine Dressing Forceps
Pinzas para tapones
Pinces pour eponges



Bozemann
SS-08-443
26 cm / 10 $\frac{1}{4}$ "



Bozemann
SS-08-444
26 cm / 10 $\frac{1}{4}$ "



Fletcher (Javerts)
SS-08-445
24 cm / 9 $\frac{1}{2}$ "



SAPTESTAR

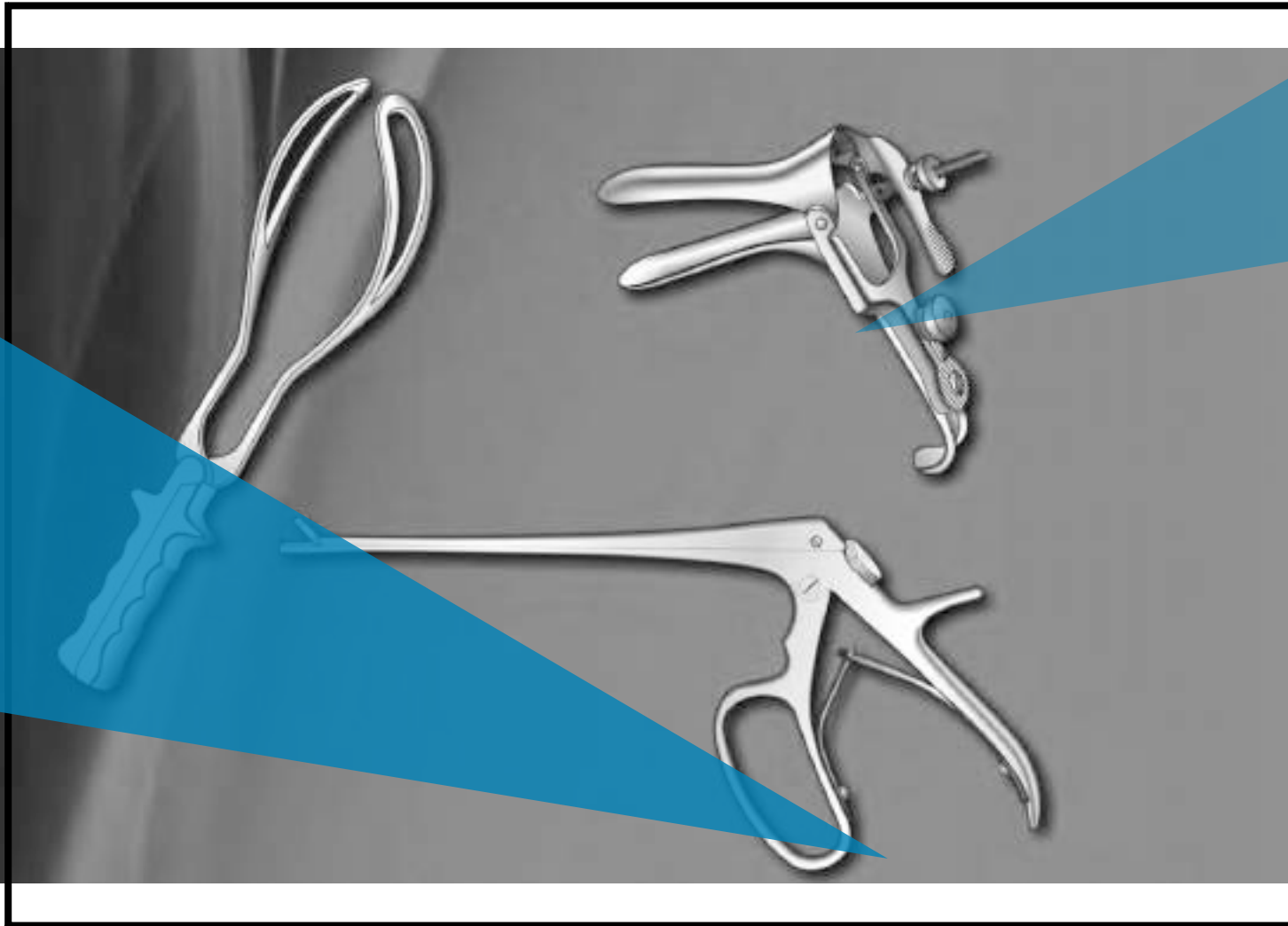

**Manufacturers & Exporters Of Quality Surgical Instruments
Gynecology Instruments Catalogue**

Group 9 & 10

Gynecology Obstractics

9 & 10



+92-340-4040061



exportsaptestar@gmail.com



info@saptestar.com



www.saptestar.com



Defence Road, Near Hotel Javson, 51310-Sialkot Pakistan

Company Profile



ABOUT US

Quality begins at **SapteStar** Instruments Company where master craftsmen forge and manufacture each instrument to its exact specifications and measurements. Instruments must undergo a series of quality control inspections in order to be worthy of **SapteStar** name and warranty. We offer a wide selection of medical instruments including Surgical and Dental instruments.

We have acquired a unique and unmatched understanding of manufacturing through a large experience, working since 1908. Years of experience & state of the art manufacturing facilities helped us to keep our prices low. Our Surgical & Dental instruments are created by expert craftsmen, providing unfaltering quality you can rely on.

We have launched a fully interactive website where you can get online and track your orders 24 hours a day, 7 days in a week, and 365 days a year. Ask for our free e-catalogue on CD-Rom to save time and enjoy hassle free ordering.

We provide our customers with most reliable customer service as your satisfaction is our top priority. Our customers always enjoy our wonderful customer service and quality tools at the best price.

Lastly we invite you to have a work experience with SapteStar Instruments Company and we will prove ourselves as one of the most valuable source you have.

You can find us at

SapteStar
CEO



Company Profile



History

SAPTESTAR INSTRUMENTS was founded in 1995. Our Great Grandfather **Mian Muhammad Fazal Elahi** was the founder of M/s M.F. Elahi & Company (E.P.) Pvt. Ltd, established in 1908. SapteStar is a sister concern of M.F. Elahi & Co. It is our pride to be a member of M.F. Elahi Family.

SapteStar Instruments Company is located in the heart of beautiful city, Sialkot, Pakistan. We are manufacturers and exporters of quality Surgical, Dental instruments and Scissors of all sorts in various categories. We are closely attached with highly skilled surgeons and other technicians of the surgical industry to make the new instruments development possible.

SapteStar is in a continues process of development and testing of new instruments for their precision and perfect functioning. We are also working at imported forging supply by foreign customers.

Certificates

Instruments Company has achieved the certificates for ISO-9001, ISO-13485, cGMP (FDA) and CE Marking.

Quality Control

All material use in the manufacturing of our instruments are tested from relevant laboratories. Our continuous quality control is our best warranty so that you built confidence in our products.

Deliveries

Deliveries are quick and in-time.

Mode Of Payment

Terms of Payment is ADVANCE or LETTER OF CREDIT (Irrevocable)



Gynecology 09

09 Gynecology

Adair	29	Simon	1
Alexander	41	Simpson	27, 1
Aspirating	6	Sims	2, 11, 27
Auvar	19	Somer	37
Auvar-Berlind	19	Staude-Moore	29
Baby-Tischler	42	Teale	34
Barrett	29	Thoms-Gaylor	38
Berger	40	Tischler	42
Blake	1	Tischler-Morgan	40
Braun	30, 31	Townsend	42
Breisky	18	Trelat	8
Bruenings	43	Utrine	4
Bumm	5	Valleix	27
Burke	42	Van Doren	39
Collin	8, 37	Wittner	40
Collin-Landau	8	Schubert	39, 38
Cusco	7, 8		
Czerny	33		
Doyen	16, 17, 35		
Duplay	28		
Emmet	26		
Gourdet	1		
Grave Modif	9		
Grave	9, 10		
Hank	23		
Hartmann	40		
Hegar	21, 22		
Heywood-Smith	35		
Huber Handle	43		
Hulka	28		
Hulka-Kenwick	28		
Jacobs	34		
Kallmorgen	15		
Kelly	35		
Kevourian-Pacific	42		
Kevourian-Young	36, 41, 44		
Kogan	24, 25		
Krause	41		
Kristeller	11-14		
Lahey	31		
Landau	18		
Laser Surgery Instruments	26		
Mathieu	17		
Matzenauer	18		
Mod. Munchen	36		
Museux	34		
Noto	35		
Novak	36		
Pederson	9, 10		
Pozzi	28		
Pratt	33		
Randall	36		
Recamier	03		
Scheinmann	41		
Scherback	20		
Schroder	1, 30, 31, 32		
Schumacher	41, 44		
Semm	9		



SAPTESTAR
 Manufacturer & Exporter Of Surgical, Dental & Veterinary Instruments

Utrine Scoops, Curette
 Cucharillas uterinas, cureta
 Curettes uterines



1
SS-09-101
 6.8 mm



2
SS-09-102
 8.5 mm



3
SS-09-103
 10.0 mm



4
SS-09-104
 11.5 mm



5
SS-09-105
 13.0 mm



6
SS-09-106
 14.5 mm



1
SS-09-107
 6.8 mm



2
SS-09-108
 8.5 mm



3
SS-09-109
 10.0 mm



4
SS-09-110
 11.5 mm



5
SS-09-111
 13.0 mm



6
SS-09-112
 14.5 mm



SS-09-113
 6.0 mm



SS-09-114
 8.0 mm



SS-09-115
 10.0 mm



SS-09-116
 12.0 mm



SS-09-117
 14.0 mm

13 mm



Blunt
 romas
 mousse

Sharp
 cortantes
 tranchantes



8 mm



Simon
 25 cm
 Uterine scoops, sharp / rigid
 Cucharillas uterinas, cortant / rigidas
 Curettes uterines, tranchantes / rigides



Schroder
 30 cm
 Uterine scoops, sharp / rigid
 Cucharillas uterinas, cortant / rigidas
 Curettes uterines, tranchantes, rigides



Gourdet
 28 cm
 Uterine scoops, blunt / rigid
 Cucharillas uterinas, romas / rigidas
 Curettes uterines, mousses, rigides



Blake
SS-09-118
 27.5 cm
 Uterine curette
 Cureta uterina
 Curette uterine

Utrine Curettes
Curetas uterinas
Curettes uterines

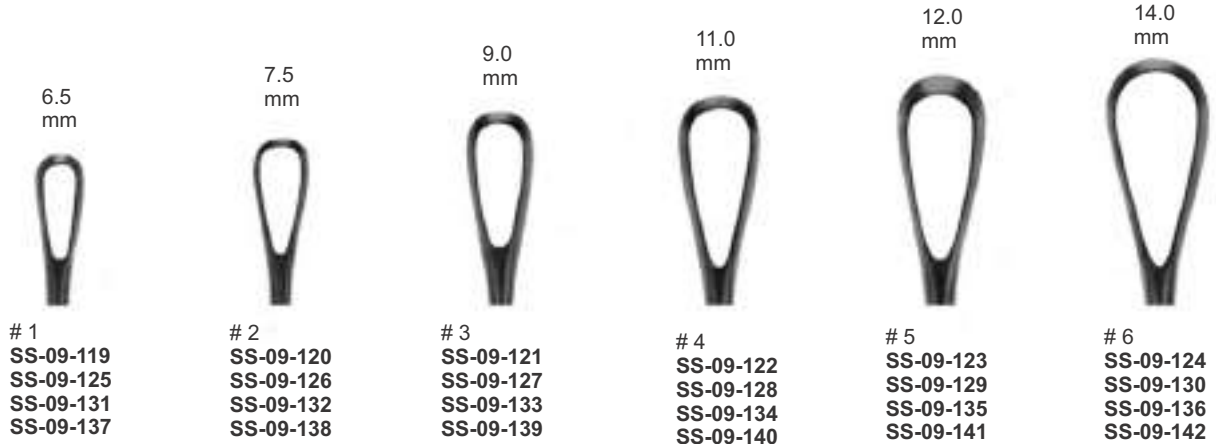

Sims

SS-09-119 Fig 1 6.5 mm
 SS-09-120 Fig 2 7.5 mm
 SS-09-121 Fig 3 9.0 mm
 SS-09-122 Fig 4 11.0 mm
 SS-09-123 Fig 5 12.0 mm
 SS-09-124 Fig 6 14.0 mm
 24.5 - 26.0 cm
 sharp,rigid
 cortantes, rigidas
 tranchantes, rigides

Sims

SS-09-125 Fig 1 6.5 mm
 SS-09-126 Fig 2 7.5 mm
 SS-09-127 Fig 3 9.0 mm
 SS-09-128 Fig 4 11.0 mm
 SS-09-129 Fig 5 12.0 mm
 SS-09-130 Fig 6 14.0 mm
 24.5 - 26.0 cm
 sharp,malleable
 cortantes, maleables
 tranchantes, malleables

Sims

SS-09-131 Fig 1 6.5 mm
 SS-09-132 Fig 2 7.5 mm
 SS-09-133 Fig 3 9.0 mm
 SS-09-134 Fig 4 11.0 mm
 SS-09-135 Fig 5 12.0 mm
 SS-09-136 Fig 6 14.0 mm
 24.5 - 26.0 cm
 blunt,rigid
 romas, rigidas
 mousses, rigides

Sims

SS-09-137 Fig 1 6.5 mm
 SS-09-138 Fig 2 7.5 mm
 SS-09-139 Fig 3 9.0 mm
 SS-09-140 Fig 4 11.0 mm
 SS-09-141 Fig 5 12.0 mm
 SS-09-142 Fig 6 14.0 mm
 24.5 - 26.0 cm
 blunt,malleable
 romas, maleables
 mousses, malleables

Utrine Curettes
Curetas uterinas
Curettes uterines



Recamier

SS-09-143 Fig 00 6.0 mm
SS-09-144 Fig 0 7.5 mm
SS-09-145 Fig 1 8.5 mm
SS-09-146 Fig 2 9.5 mm
SS-09-147 Fig 3 10.5 mm
SS-09-148 Fig 4 11.5 mm
SS-09-149 Fig 5 12.5 mm
SS-09-150 Fig 6 14.0 mm
SS-09-151 Fig 7 15.0 mm
SS-09-152 Fig 8 16.0 mm
SS-09-153 Fig 9 19.0 mm
SS-09-154 Fig 10 20.0 mm
 29.5 - 32.5 cm
 sharp, rigid
 cortantes, rigidas
 tranchantes, rigides

Recamier

SS-09-155 Fig 00 6.0 mm
SS-09-156 Fig 0 7.5 mm
SS-09-157 Fig 1 8.5 mm
SS-09-158 Fig 2 9.5 mm
SS-09-159 Fig 3 10.5 mm
SS-09-160 Fig 4 11.5 mm
SS-09-161 Fig 5 12.5 mm
SS-09-162 Fig 6 14.0 mm
SS-09-163 Fig 7 15.0 mm
SS-09-164 Fig 8 16.0 mm
SS-09-165 Fig 9 19.0 mm
SS-09-166 Fig 10 20.0 mm
 29.5 - 32.5 cm
 sharp, malleable
 cortantes, maleables
 tranchantes, malleables

Recamier

SS-09-167 Fig 00 6.0 mm
SS-09-168 Fig 0 7.5 mm
SS-09-169 Fig 1 8.5 mm
SS-09-170 Fig 2 9.5 mm
SS-09-171 Fig 3 10.5 mm
SS-09-172 Fig 4 11.5 mm
SS-09-173 Fig 5 12.5 mm
SS-09-174 Fig 6 14.0 mm
SS-09-175 Fig 7 15.0 mm
SS-09-176 Fig 8 16.0 mm
SS-09-177 Fig 9 19.0 mm
SS-09-178 Fig 10 20.0 mm
 29.5 - 32.5 cm
 blunt, rigid
 romas, rigidas
 mouses, rigides

Recamier

SS-09-179 Fig 00 6.0 mm
SS-09-180 Fig 0 7.5 mm
SS-09-181 Fig 1 8.5 mm
SS-09-182 Fig 2 9.5 mm
SS-09-183 Fig 3 10.5 mm
SS-09-184 Fig 4 11.5 mm
SS-09-185 Fig 5 12.5 mm
SS-09-186 Fig 6 14.0 mm
SS-09-187 Fig 7 15.0 mm
SS-09-188 Fig 8 16.0 mm
SS-09-189 Fig 9 19.0 mm
SS-09-190 Fig 10 20.0 mm
 29.5 - 32.5 cm
 blunt, malleable
 romas, maleables
 mouses, malleables

Utrine Curettes
 Curetas uterinas
 Curettes uterines

6.0
mm



00
 SS-09-143
 SS-09-155
 SS-09-167
 SS-09-179

7.5
mm



0
 SS-09-144
 SS-09-156
 SS-09-168
 SS-09-180

8.5
mm



1
 SS-09-145
 SS-09-157
 SS-09-169
 SS-09-181

9.5
mm



2
 SS-09-146
 SS-09-158
 SS-09-170
 SS-09-182

10.5
mm



3
 SS-09-147
 SS-09-159
 SS-09-171
 SS-09-183

11.5
mm



4
 SS-09-148
 SS-09-160
 SS-09-172
 SS-09-184

12.5
mm



5
 SS-09-149
 SS-09-161
 SS-09-173
 SS-09-185

14
mm



6
 SS-09-150
 SS-09-162
 SS-09-174
 SS-09-186

15
mm



7
 SS-09-151
 SS-09-163
 SS-09-175
 SS-09-187

16
mm



8
 SS-09-152
 SS-09-164
 SS-09-176
 SS-09-188

19
mm



9
 SS-09-153
 SS-09-165
 SS-09-177
 SS-09-189

20
mm



10
 SS-09-154
 SS-09-166
 SS-09-178
 SS-09-190

Utrine Curettes
Curetas uterinas
Curettes uterines

24 mm

22 mm

20 mm

18 mm

16 mm

14 mm

13 mm



0
SS-09-191
SS-09-198

1
SS-09-192
SS-09-199

2
SS-09-193
SS-09-200

3
SS-09-194
SS-09-201

4
SS-09-195
SS-09-202

5
SS-09-196
SS-09-203

6
SS-09-197
SS-09-204



Bumm
SS-09-191 Fig 0 13 mm
SS-09-192 Fig 1 14 mm
SS-09-193 Fig 2 16 mm
SS-09-194 Fig 3 18 mm
SS-09-195 Fig 4 20 mm
SS-09-196 Fig 5 22 mm
SS-09-197 Fig 6 24 mm
28 - 29 cm
sharp, malleable
cortantes, maleables
tranchantes, malleables



Bumm
SS-09-198 Fig 0 13 mm
SS-09-199 Fig 1 14 mm
SS-09-200 Fig 2 16 mm
SS-09-201 Fig 3 18 mm
SS-09-202 Fig 4 20 mm
SS-09-203 Fig 5 22 mm
SS-09-204 Fig 6 24 mm
28 - 29 cm
blunt, malleable
romas, maleables
mousses, malleables

Aspirating Currettes
Curetas de aspiracion
Currettes d' aspiration

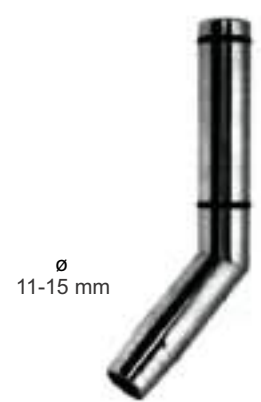
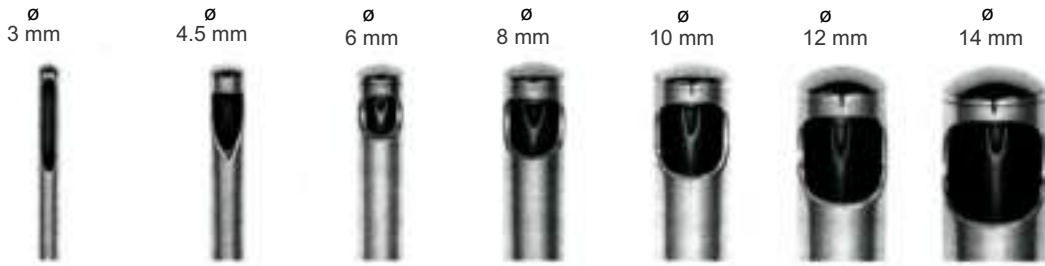

SS-09-212
Coupling piece for the connection of aspirating currettes SS-09-207 - SS-09-211 to flexible tube having an interior diameter of 11 mm

Adaptador de tubo para curetas de aspiracion SS-09-207 - SS-09-211 para tubos de aspiracion, \emptyset interior de 11 mm
Embout adaptable aux curettes SS-09-207 - SS-09-211 Pour tube d' aspiration, \emptyset intérieur á 11 mm

- SS-09-205**
28.5 cm
- SS-09-206**
28.5 cm
- SS-09-207**
28.5 cm
- SS-09-208**
28.5 cm
- SS-09-209**
28.5 cm
- SS-09-210**
28.5 cm
- SS-09-211**
28.5 cm

Specimen and aspirating currettes
Curetas de biopsia y de aspiracion
Currettes á biopsie et d'aspiration

Aspirating currettes
Curetas de aspiracion
Currettes d' aspiration

Vaginal Specula
Especulos vaginales
Speculums vaginalux



Cusco

SS-09-213

75 x 17 mm (AxB)

Vaginal speculum for virgins with lateral fixation screw,
tilt-down handle

Espécule vaginal para vírgenes, con tornillo de
sujeto lateral, mango plegable

Spéculum vaginal pour vierges, avec fixation latérale á vis



Cusco

SS-09-214 75 x 32 mm (AXB)

SS-09-215 85 x 32 mm (AXB)

SS-09-216 100 x 35 mm (AXB)

Vaginal speculum for virgins with lateral fixation screw,
tilt-down handle

Espécule vaginal para vírgenes, con tornillo de
sujeto lateral, mango plegable

Spéculum vaginal pour vierges, avec fixation latérale á vis



Cusco

SS-09-217

75 x 17 mm (AxB)

Vaginal speculum for virgins with central fixation screw,
tilt-down handle

Espécule vaginal para vírgenes, con tornillo de
sujeto central, mango plegable

Spéculum vaginal pour vierges, avec fixation centrale á vis



Cusco

SS-09-218 75 x 32 mm (AXB)

SS-09-219 85 x 35 mm (AXB)

SS-09-220 100 x 35 mm (AXB)

Vaginal speculum for virgins with central fixation screw,
tilt-down handle

Espécule vaginal para vírgenes, con tornillo de
sujeto central, mango plegable

Spéculum vaginal pour vierges, avec fixation centrale á vis

Vaginal Specula
Especulos vaginales
Speculum vaginalux



Cusco

SS-09-221 90 x 22-25 mm (AxB)

SS-09-222 100 x 25-27 mm (AxB)

SS-09-223 105 x 27-30 mm (AxB)

Vaginal specula, Swiss pattern, cone shaped, with lateral fixation screw, tilt-down handle

Especulos vaginales, modelo suizo (cónico), con tornillo de sujeto lateral, mango plegable

Spéculum vaginalux, modèle suisse (conique), avec fixation latéral a vis



Trelat

SS-09-224 85 x 33 mm (AXB)

SS-09-225 95 x 35 mm (AXB)

SS-09-226 115 x 43 mm (AXB)

Vaginal specula, parallel opening, tilt-down handle

Especulos vaginales, apertura paralela, mango plegable

Spéculum vaginalux, á valves parallèles



Collin

SS-09-227 90 x 28 mm (AxB)

SS-09-228 100 x 35 mm (AxB)

SS-09-229 110 x 40 mm (AxB)

Vaginal specula

Especulos vaginales

Spéculum vaginalux



Collin-Landau

SS-09-230 90 x 28 mm (AXB)

SS-09-231 100 x 35 mm (AXB)

SS-09-232 110 x 40 mm (AXB)

Vaginal specula, upper blade of specula shortened

Especulos vaginales, valvas superior más corta

Spéculum vaginalux, valve supérieure plus courte

Vaginal Specula
Especulos vaginales
Speculums vaginalux



Semm

SS-09-233 90 x 14-18 mm (AXB)

SS-09-234 100 x 17-20 mm (AXB)

SS-09-235 100 x 25-30 mm (AXB)

Vaginal specula with double lock,
one-hand operated
Espéculos vaginales con cierre doble,
para el uso con una mano
Spéculums vaginaux, double ouverture
utilisé à la main



Pederson

SS-09-236 75 x 13 mm (AXB)

SS-09-237 100 x 16 mm (AXB)

SS-09-238 100 x 22 mm (AXB)

SS-09-239 120 x 25 mm (AXB)

Vaginal specula
Espéculos vaginales
Spéculums vaginaux



Grave

SS-09-240 75 x 20 mm (AXB)

SS-09-241 95 x 35 mm (AXB)

SS-09-242 115 x 35 mm (AXB)

Vaginal specula
Espéculos vaginales
Spéculums vaginaux



Grave modif.

SS-09-243

100 x 35 mm (AXB)

Vaginal speculum, right side open
Espéculo vaginal, parte derecha abierta
Spéculum vaginaux, ouverts à droite

Vaginal Specula
Especulos vaginales
Speculum vaginalux

Surface black-finish
Superficie negra
Surface noire

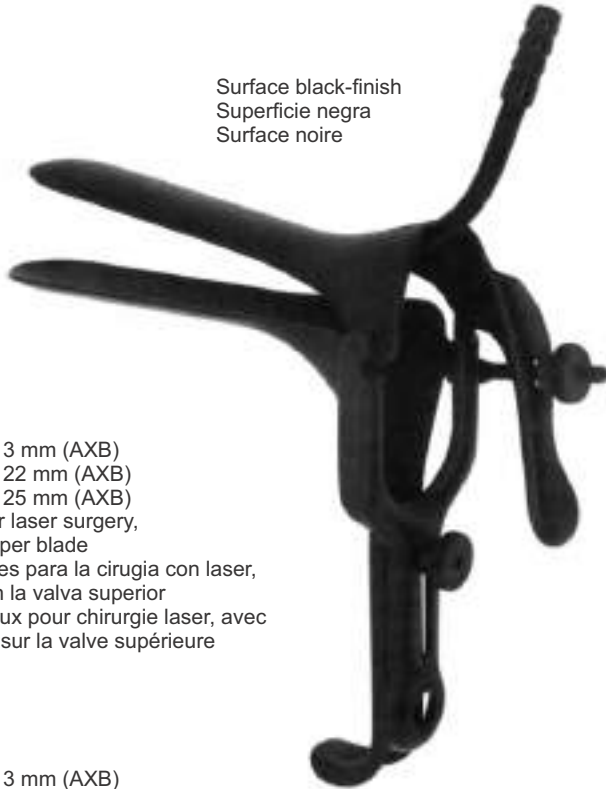

Pederson

SS-09-244 75 x 13 mm (AXB)

SS-09-245 100 x 22 mm (AXB)

SS-09-246 120 x 25 mm (AXB)

Vaginal specula for laser surgery,
suctioning from upper blade

Especulos vaginales para la cirugía con laser,
tubo de succión en la valva superior

Spéculum vaginalux pour chirurgie laser, avec
embout aspiration sur la valve supérieure

Pederson

SS-09-247 75 x 13 mm (AXB)

SS-09-248 100 x 22 mm (AXB)

SS-09-249 120 x 25 mm (AXB)

Vaginal specula for laser surgery,
suctioning for lower blade

Especulos vaginales para la cirugía con laser,
tubo de succión en la valva inferior

Spéculum vaginalux pour chirurgie laser, avec
embout aspiration sur la valve inférieure

Surface black-finish
Superficie negra
Surface noire



Grave

SS-09-250 75 x 20 mm (AXB)

SS-09-251 95 x 35 mm (AXB)

SS-09-252 115 x 35 mm (AXB)

Vaginal specula for laser surgery,
suctioning for lower blade

Especulos vaginales para la cirugía con laser,
tubo de succión en la valva superior

Spéculum vaginalux pour chirurgie laser, avec
embout aspiration sur la valve supérieure

Grave

SS-09-253 75 x 20 mm (AXB)

SS-09-254 95 x 35 mm (AXB)

SS-09-255 115 x 35 mm (AXB)

Vaginal specula for laser surgery,
suctioning for lower blade

Especulos vaginales para la cirugía con laser,
tubo de succión en la valva inferior

Spéculum vaginalux pour chirurgie laser, avec
embout aspiration sur la valve inférieure

Vaginal Specula & Retractors
 Especulos y valvas vaginales
 Speculums et valves vaginalux



1/2

Sims

- SS-09-256** 65 x 25 mm / 70 x 30 mm
- SS-09-257** 70 x 30 mm / 70 x 35 mm
- SS-09-258** 85 x 35 mm / 90 x 40 mm



Kristeller

- SS-09-259** Fig. 1 70 x 27 mm
- SS-09-260** Fig. 2 80 x 30 mm
- SS-09-261** Fig. 3 90 x 36 mm

Kristeller

- SS-09-262** Fig. 1 75 x 23 mm
- SS-09-263** Fig. 2 85 x 26 mm
- SS-09-264** Fig. 3 100 x 32 mm

Kristeller

- SS-09-265** =
 - SS-09-266** =
 - SS-09-267** =
- Sets

Consisting of
 Consiste de
 Se composant de
SS-09-259 + SS-09-262
SS-09-260 + SS-09-263
SS-09-261 + SS-09-264

Slender pattern
modelo delgado
modèle gracile



Kristeller
SS-09-268 Fig. 1 105 x 18 mm
SS-09-269 Fig. 2 105 x 21 mm

Kristeller
SS-09-270 Fig. 1 110 x 14 mm
SS-09-271 Fig. 2 110 x 17 mm

Kristeller
SS-09-272 = Consisting of
SS-09-273 = Consiste de
Sets = Se composant de
SS-09-261 + SS-09-269

Vaginal Specula & Retractors
 Especulos y valvas vaginales
 Speculum et valves vaginalux



Flat speculum
 espéculo plano
 spéculum plat



Kristeller
SS-09-274 Fig. 1 105 x 26 mm
SS-09-275 Fig. 2 105 x 28 mm
SS-09-276 Fig. 3 105 x 33 mm



Kristeller
SS-09-277 Fig. 1 115 x 22 mm
SS-09-278 Fig. 2 115 x 24 mm
SS-09-279 Fig. 3 115 x 29 mm



Kristeller
SS-09-280 = Consisting of
SS-09-281 = Consiste de
SS-09-282 = Se composant de
 Sets **SS-09-274 + SS-09-277**
SS-09-275 + SS-09-278
SS-09-276 + SS-09-279



Deep speculum
espéculo profundo
spéculum profond



Kristeller
SS-09-283 Fig. 1 110 x 27 mm
SS-09-284 Fig. 2 110 x 30 mm
SS-09-285 Fig. 3 110 x 36 mm



Kristeller
SS-09-286 Fig. 1 115 x 22 mm
SS-09-287 Fig. 2 115 x 24 mm
SS-09-288 Fig. 3 115 x 29 mm



Kristeller
SS-09-289 = Consisting of
SS-09-290 = Consiste de
SS-09-291 = Se composant de
Sets = **SS-09-283 + SS-09-286**
= **SS-09-284 + SS-09-287**
= **SS-09-285 + SS-09-288**

Vaginal Specula & Retractors
Especulos y valvas vaginales
Speculum et valves vaginalux



Kallmorgen
SS-09-292 Fig. 1 70 x 40 mm
SS-09-293 Fig. 2 90 x 40 mm



Kallmorgen
SS-09-294 Fig. 1 70 x 33 mm
SS-09-295 Fig. 2 90 x 33 mm



Kallmorgen
SS-09-296 = Consisting of
SS-09-297 = Consiste de
Sets = Se composant de
SS-09-292 + SS-09-294
SS-09-293 + SS-09-295



Slightly concave
 ligeramente concave
 légèrement concave

- | | | |
|------------------|--------|-------------|
| SS-09-298 | Fig. 1 | 63 x 35 mm |
| SS-09-299 | Fig. 2 | 94 x 35 mm |
| SS-09-300 | Fig. 3 | 124 x 35 mm |
| SS-09-301 | Fig. 1 | 66 x 47 mm |
| SS-09-302 | Fig. 2 | 95 x 47 mm |
| SS-09-303 | Fig. 3 | 126 x 47 mm |
| SS-09-304 | Fig. 4 | 160 x 47 mm |
| SS-09-305 | Fig. 1 | 55 x 60 mm |
| SS-09-306 | Fig. 2 | 95 x 60 mm |
| SS-09-307 | Fig. 3 | 130 x 60 mm |
| SS-09-308 | Fig. 4 | 175 x 60 mm |

Doyen

Vaginal Specula & Retractors
Especulos y valvas vaginales
Speculums et valves vaginalux



Mathieu
SS-09-309 95 x 13-23 mm (AXB)
SS-09-310 95 x 16-30 mm (AXB)
Specula only
Especulos sueltos
Spéculums seuls



Mathieu
SS-09-311 100 x 11-21 mm (AXB)
SS-09-312 100 x 14-27 mm (AXB)
Retractors only
Valvas sueltas
Valves seules



Doyen
SS-09-313 60 x 30 mm (AXB)
SS-09-314 70 x 30 mm (AXB)
SS-09-315 80 x 30 mm (AXB)

Vaginal Specula
Especulos vaginales
Speculum vaginalux



Matzenauer

- SS-09-316** 125 x 15 mm (AXB)
- SS-09-317** 125 x 20 mm (AXB)
- SS-09-318** 125 x 25 mm (AXB)
- SS-09-319** 125 x 30 mm (AXB)
- SS-09-320** 125 x 35 mm (AXB)
- SS-09-321** 125 x 40 mm (AXB)



Landau

- SS-09-322** 100 x 28 mm (AXB)
- SS-09-323** 110 x 38 mm (AXB)



Breisky

- SS-09-324** 100 x 15 mm (AXB)
- SS-09-325** 100 x 20 mm (AXB)
- SS-09-326** 100 x 25 mm (AXB)
- SS-09-327** 100 x 30 mm (AXB)
- SS-09-328** 100 x 35 mm (AXB)
- SS-09-329** 100 x 40 mm (AXB)
- SS-09-330** 130 x 15 mm (AXB)
- SS-09-331** 130 x 20 mm (AXB)
- SS-09-332** 130 x 25 mm (AXB)
- SS-09-333** 130 x 30 mm (AXB)
- SS-09-334** 130 x 35 mm (AXB)
- SS-09-335** 130 x 40 mm (AXB)
- SS-09-336** 160 x 40 mm (AXB)
- SS-09-337** 180 x 40 mm (AXB)

Vaginal Specula
Especulos vaginales
Speculum vaginalux



Auvard-Berlind
SS-09-338
102 x 45 mm (AXB)
1.14 kg
Vaginal speculum with fixed
weight and holes in blade
Espéculo vaginal con peso
fijo y valva perforada
Spéculum vaginal avec poids
fixe et valve á trous



Auvard
SS-09-339
83 x 38 mm (AXB)
0.91 kg
SS-09-340
83 x 38 mm (AXB)
1.14 kg
SS-09-341
83 x 38 mm (AXB)
1.36 kg
Vaginal speculum with fixed weight
Especulo vaginal con peso fijo
Speculum vaginal avec poids fixe



Auvard
SS-09-342
102 x 45 mm (AXB)
1.14 kg
Vaginal speculum with detachable weight
Espéculo vaginal con peso desmontable
Spéculum vaginal avec poids démontable



**Scherback
SS-09-343**

Set, consisting of:

- SS-09-344** 1 Handle
- SS-09-345** 1 Weight 0.4 kg
- SS-09-347** 1 Blade 80 x 30 mm
- SS-09-348** 1 Blade 85 x 35 mm
- SS-09-349** 1 Blade 85 x 40 mm
- SS-09-350** 1 Blade 55 x 40-60 mm
- SS-09-351** 1 Blade 70 x 45-70 mm

Jeu, composé de:

- SS-09-344** 1 Manche
- SS-09-345** 1 Poids 0.4 kg
- SS-09-347** 1 Valve 80 x 30 mm
- SS-09-348** 1 Valve 85 x 35 mm
- SS-09-349** 1 Valve 85 x 40 mm
- SS-09-350** 1 Valve 55 x 40-60 mm
- SS-09-351** 1 Valve 70 x 45-70 mm

Juego, compuesto de:

- SS-09-344** 1 Mango
- SS-09-345** 1 Peso 0.4 kg
- SS-09-347** 1 Valva 80 x 30 mm
- SS-09-348** 1 Valva 85 x 35 mm
- SS-09-349** 1 Valva 85 x 40 mm
- SS-09-350** 1 Valva 55 x 40-60 mm
- SS-09-351** 1 Valva 70 x 45-70 mm

Utrine Dilator
 Dilatador uterino
 Dilatateurs du col de l' uterus



Hegar

SS-09-352	∅	1.0 mm
SS-09-353	∅	2.0 mm
SS-09-354	∅	3.0 mm
SS-09-355	∅	4.0 mm
SS-09-356	∅	5.0 mm
SS-09-357	∅	6.0 mm
SS-09-358	∅	7.0 mm
SS-09-359	∅	8.0 mm
SS-09-360	∅	9.0 mm
SS-09-361	∅	10.0 mm
SS-09-362	∅	11.0 mm
SS-09-363	∅	12.0 mm
SS-09-364	∅	13.0 mm
SS-09-365	∅	14.0 mm
SS-09-366	∅	15.0 mm
SS-09-367	∅	16.0 mm
SS-09-368	∅	17.0 mm
SS-09-369	∅	18.0 mm
SS-09-370	∅	19.0 mm
SS-09-371	∅	20.0 mm
SS-09-372	∅	21.0 mm
SS-09-373	∅	22.0 mm
SS-09-374	∅	23.0 mm
SS-09-375	∅	24.0 mm
SS-09-376	∅	25.0 mm
SS-09-377	∅	26.0 mm

18.5 cm

with sloped handle
 con mango aplanado
 á manche aplati



Hegar

SS-09-378	∅	1.5 mm
SS-09-379	∅	2.5 mm
SS-09-380	∅	3.5 mm
SS-09-381	∅	4.5 mm
SS-09-382	∅	5.5 mm
SS-09-383	∅	6.5 mm
SS-09-384	∅	7.5 mm
SS-09-385	∅	8.5 mm
SS-09-386	∅	9.5 mm
SS-09-387	∅	10.5 mm
SS-09-388	∅	11.5 mm
SS-09-389	∅	12.5 mm
SS-09-390	∅	13.5 mm
SS-09-391	∅	14.5 mm
SS-09-392	∅	15.5 mm
SS-09-393	∅	16.5 mm
SS-09-394	∅	17.5 mm

18.5 cm

with sloped handle
 con mango aplanado
 á manche aplati



Hegar

SS-09-395	∅	2.0 / 3.0 mm
SS-09-396	∅	3.0 / 4.0 mm
SS-09-397	∅	5.0 / 6.0 mm
SS-09-398	∅	7.0 / 8.0 mm
SS-09-399	∅	9.0 / 10.0 mm
SS-09-400	∅	11.0 / 12.0 mm
SS-09-401	∅	13.0 / 14.0 mm
SS-09-402	∅	15.0 / 16.0 mm
SS-09-403	∅	17.0 / 18.0 mm
SS-09-404	∅	19.0 / 20.0 mm
SS-09-405	∅	21.0 / 22.0 mm
SS-09-406	∅	23.0 / 24.0 mm
SS-09-407	∅	25.0 / 26.0 mm

20 cm

Utrine Dilator
Dilatador uterino
Dilatateurs du col de l' uterus



With sloped handle
con mango aplanado
á manche aplati

Hegar

- SS-09-408**
- SS-09-409** 1 Rack for dilators \varnothing 4-12 mm
- SS-09-410** 1 Rack for dilators \varnothing 13-17 mm
- SS-09-411** 1 Metal case with hinged lid 205 x 105 x 45 mm (wxdxh)

- SS-09-409** 1 Soporte para dilatadores \varnothing 4-12 mm
- SS-09-410** 1 Soporte para dilatadores de \varnothing 13-17 mm
- SS-09-411** 1 Estuche de metal con tapa de bisagra 205 x 105 x 45 mm

- SS-09-409** 1 Chevalet pour dilateurs \varnothing 4-12 mm
- SS-09-410** 1 Chevalet pour dilateurs \varnothing 13-17 mm
- SS-09-411** 1 Boîte métal avec couvercle á charnière 205 x 105 x 45 mm



Hegar

- SS-09-412**
- SS-09-413** 1 Rack for dilators \varnothing 1-17 mm
- SS-09-414** 1 Rack for dilators \varnothing 18-26 mm
- SS-09-415** 1 Metal case with hinged lid 310 x 210 x 55 mm (wxdxh)

- SS-09-413** 1 Soporte para dilatadores de \varnothing 1-17 mm
- SS-09-414** 1 Soporte para dilatadores de \varnothing 18-26 mm
- SS-09-415** 1 Estuche de metal con tapa de bisagra 310 x 210 x 55 mm

- SS-09-413** 1 chevalet pour dilateurs de \varnothing 1-17 mm
- SS-09-414** 1 chevalet pour dilateurs de \varnothing 18-26 mm
- SS-09-415** 1 Boîte métal avec couvercle á charnière 310 x 210 x 55 mm



Hegar

- SS-09-416**
- SS-09-417** 1 Boilable canvas roll
- SS-09-417** 1 Bolsa de tela esterilizable por ebullición
- SS-09-417** 1 Trousse stérilisable par ébullition

Utrine Dilator
Dilatador uterino
Dilatateurs du col de l'uterus



Hank
SS-09-418
set of 6 piezas
in boilable canvas roll
juego de 6 piezas
en bolsa de tela esterilizable por ebullición
jeu de 6 pièces en pochette en treillis stériliable par ébullition

Hank
SS-09-419 4.5 / 5.0 mm \emptyset
SS-09-420 5.5 / 6.0 mm \emptyset
SS-09-421 6.5 / 7.0 mm \emptyset
SS-09-422 7.5 / 8.0 mm \emptyset
SS-09-423 8.5 / 9.0 mm \emptyset
SS-09-424 9.5 / 10.0 mm \emptyset

American scale
escala americana
échelle américaine

Endospecula, Utrine Dilator
Endoespeculos, Dilatador uterino
Endospeculums, Dilatateurs du col de l'uterus

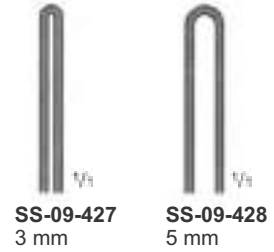

Kogan
SS-09-425
24 cm
Endospeculum for cervix and urethra, without catch
Endoespéculo para uretra y cerviz, sin cierre
Endospeculum pour urètre et col utérin, sans verrou



Kogan
SS-09-426
24 cm
Endospeculum for cervix and urethra, with
scale-ratchet and fixing screws
Endoespéculo para uretra y cerviz, con cierre
graduado tornillo fijador
Endospeculum pour uretre et col utérin
crémaillere á vis



Kogan
SS-09-427
SS-09-428
27 cm
Endospecula for cervix and
urethra, with catch
Endoespéculos para uretra
y cerviz, sin cierre
Endospeculums pour uretre
et col utérin avec crémaillère,
avec verrou

Instruments for Laser Surgery, Surface Black Finish
Instrumentos para la cirugía laser, superficie negra
Instrumens pour la chirurgie laser, surface noire



SS-09-430
3 mm



SS-09-431
5 mm



SS-09-429
25 cm
Lateral speculum
Espéculo lateral
Speculum latéral



KOGAN
SS-09-430
SS-09-431
27 cm
Endospecula for cervix and urethra
Endoespéculos para cerviz y uretra
Speculums pour urètre et col utérin



SS-09-432
24,5 cm
Hook
Gancho
Crochet

EMMET
SS-09-433
24,5 cm
Hook
Gancho
Crochet

SS-09-434
24,5 cm
Hook
Gancho
Crochet

SS-09-435
23,5 cm
Hook
Gancho
Crochet

SS-09-436
26 cm
Hook
Gancho
Crochet

Utrine Probes
Histerometros
Hystermetres

Ø 4.0 mm



**Sims
SS-09-437**
34 cm
graduated in inch,
malleable, silve-plated

graduado en pulgadas,
maleable, plateado

gradu , en pouces,
mall able, argent

Ø 4.0 mm



**Sims
SS-09-438**
34 cm
graduated in centimeters,
malleable, silver-plated

graduado en centimetros,
maleable, plateado

gradu , en cm,
mall able, argent

Ø 4.0 mm



**Sims
SS-09-439**
34 cm
graduated in centimeters,
malleable, 18/8 steel

graduado en centimetros,
maleable, acero 18/8

gradu , en cm,
mall able, acier inox

Ø 4.0 mm



**Simpson
SS-09-440**
34 cm
graduated in centimeters,
malleable, silver-plated

graduado en centimetros,
maleable, plateado

gradu , en cm,
mall able, argent

Ø 4.0 mm



**Valleix
SS-09-441**
29 cm
graduated in centimeters, with silder,
malleable, chromium plated

graduado en centimetros, con un cursor,
maleable, cromado

gradu , en cm avec curseur,
mall able, chrom 

Utrine Tenaculum Forceps
Pinzas para conger el cuello del utero
Pinces pour abaissement du col de l'uterus

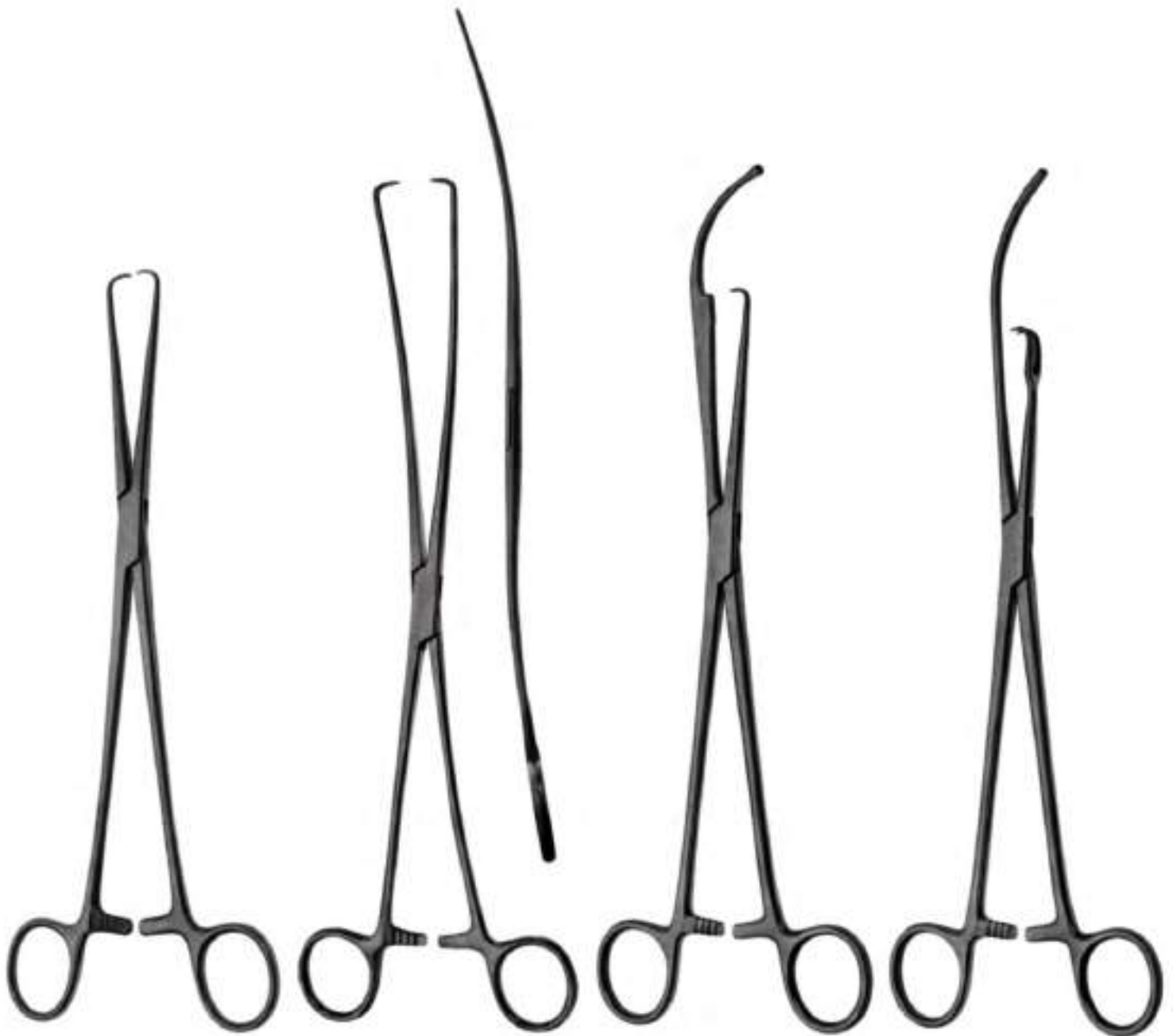

Pozzi
SS-09-442
25.5 cm
heavy pattern
modelo fuerte
modèle fort

Duplay
SS-09-443
28.5 cm

Hulka
SS-09-444
29 cm

Hulka-Kenwick
SS-09-445
29 cm

Utrine Tenaculum Forceps
Pinzas para conger el cuello del utero
Pinces pour abaissement du col de l'uterus



Staude-Moore
SS-09-446
17 cm



Barrett
SS-09-447
18 cm



Adair
SS-09-448
18.5 cm

Utrine Tenaculum Forceps
Pinzas para conger el cuello del utero
Pinces pour abaissement du col de l'uterus



Schröder
SS-09-449
25.5 cm



Schröder
SS-09-450
25 cm



Braun
SS-09-451
25 cm

Utrine Tenaculum Forceps
Pinzas para conger el cuello del utero
Pincés pour abaissement du col de l'uterus



Lahey
SS-09-452
15.5 cm



Braun
SS-09-453
15.5 cm

Utrine Tenaculum Forceps
 Pinzas para conger el cuello del utero
 Pinces pour abaissement du col de l'uterus



Schröder
SS-09-454
 25 cm
 Straight
 recta
 droits



Schröder
SS-09-455
 25 cm
 curved on flat
 curva sobre el plano
 courbe sur le plat



Schröder
SS-09-456
 25 cm
 curved sideways
 curva lateral
 courbe sur le côté

Utrine Tenaculum Forceps
Pinzas para conger el cuello del utero
Pinces pour abaissement du col de l'uterus



Czerny
SS-09-457
21 cm



Pratt
SS-09-458
26 cm



Pratt
SS-09-459
27.5 cm

Utrine Tenaculum Forceps
Pinzas para conger el cuello del utero
Pinces pour abaissement du col de l'uterus



Jacobs
SS-09-460
21 cm
Straight
recta
droit



Teale
SS-09-461
SS-09-462
Curved side ways
curva lateral
courbe sur le côté



Museux
SS-09-463
SS-09-464
Straight
rectas
droits



Museux
SS-09-465
SS-09-466
curved sideways
curva lateral
courbe sur le côté



Polypus & Ovum Forceps
Pinzas para polipos uterinos y ovarios
Pinces a polypes et ovaires

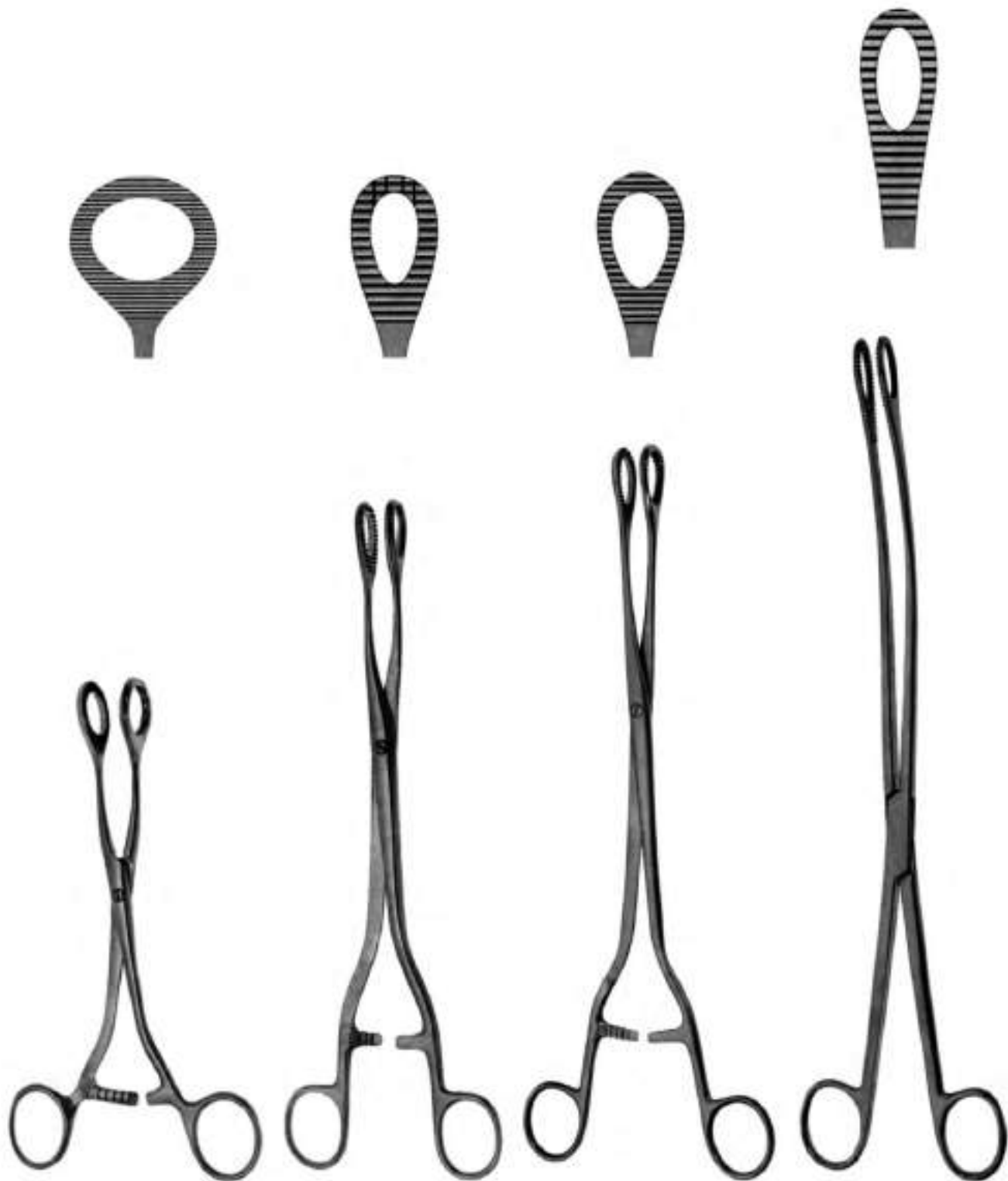

Doyen
SS-09-467
18.5 cm

Heywood-Smith
SS-09-468
25 cm

Noto
SS-09-469
27 cm

Kelly
SS-09-470
31 cm

Biopsy Curettes
Curetas para biopsia
Curettes pour biopsie

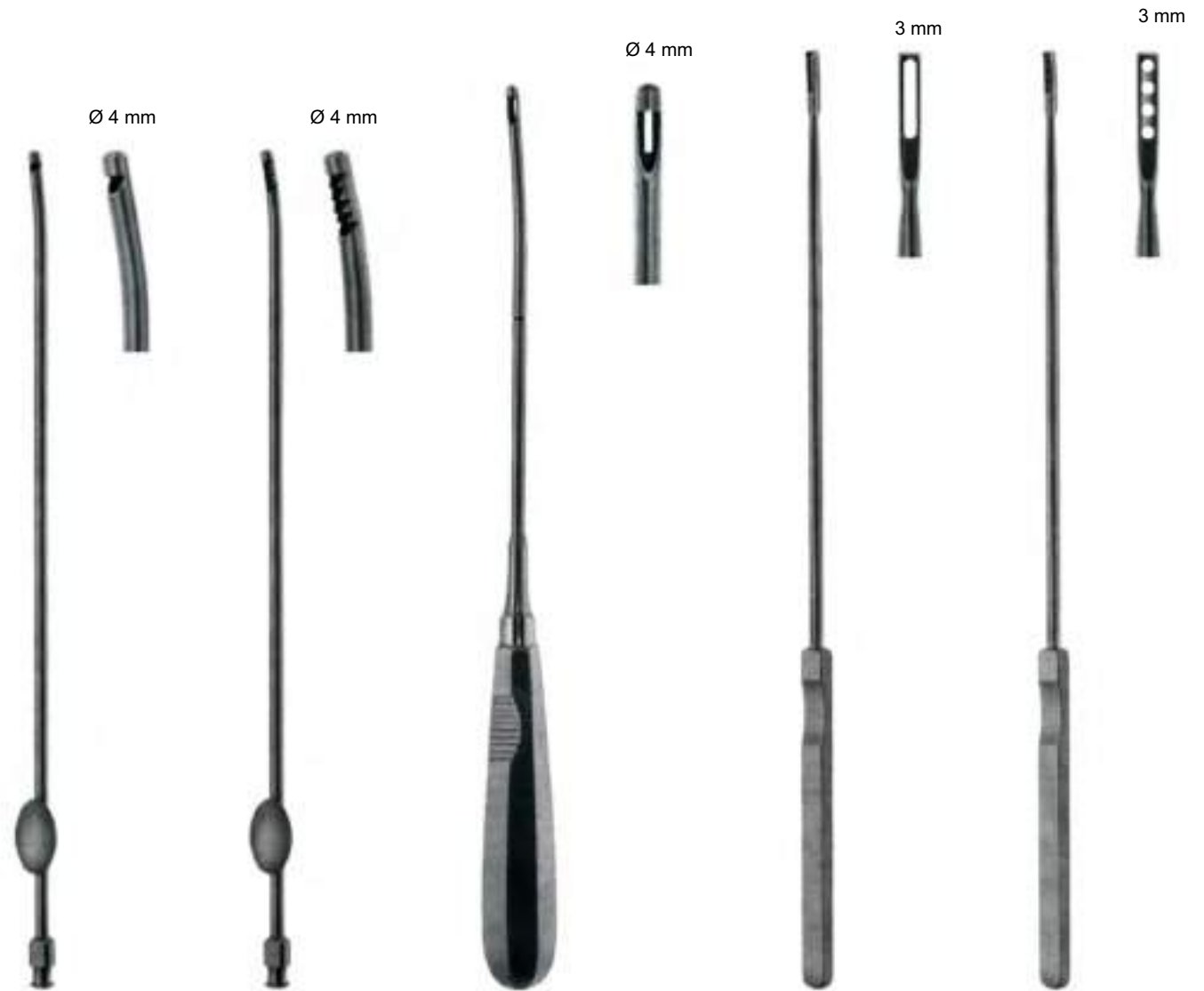

Randall
SS-09-471
25 cm
Endometrical suction
biopsy curette

Cureta aspiradora para
biopsia endo-uterina

Curette aspiratrice pour
biopsie de l'endomètre

Novak
SS-09-472
25 cm
Endometrical suction
biopsy curette

Cureta aspiradora para
biopsia endo-uterina

Curette aspiratrice pour
biopsie de l'endomètre

Mod.München
SS-09-473
27 cm
Endometrical biopsy curette

Cureta para biopsia endo-uterina

Curette biopsie de l'endomètre

Kevourkian-Young
SS-09-474
28cm
Endocervical biopsy
curette

Cureta para biopsia
endo-cerviz

Curette á biopsie
endo-cervicale

Kevourkian-Young
SS-09-475
28cm
Endocervical biopsy
curette

Cureta para biopsia
endo-cerviz

Curette á biopsie
endo-cervicale

Utrine Elevating Forceps
Pinzas para el utero
Pinces hysterolabes



With movable jaws
con mandibula movable
avec mors mobiles



Somer
SS-09-476
23 cm
Uterine elevating forceps
Pinza para el útero
Pince hystérolabe



Collin
SS-09-477
26.5 cm
Utrine elevating forceps
Pinza para el útero
Pince hystérolabe

Cervical Biopsy & Specimen Forceps
Pinzas saca-bocados para biopsia
Pinces emporte-pieces a biopsie



Thoms-Gaylor
SS-09-478
24 cm
Cervical biopsy and specimen forceps
Pinza saca-bocados para biopsia
Pince emporte-pièces à biopsie



Schubert
SS-09-479
28.5 cm
Uterine Biopsy Forceps

Cervical Biopsy & Specimen Forceps
Pinzas saca-bocados para biopsia
Pinces emporte-pieces a biopsie



Schubert
SS-09-480
26 cm
Uterine Biopsy Forceps
Handle Angled To Side



Van Doren
SS-09-481
25 cm
Uterine Biopsy Forceps
S-Shaped

Cervical Biopsy & Specimen Forceps
 Pinzas saca-bocados para biopsia
 Pincas emporte-pieces a biopsie

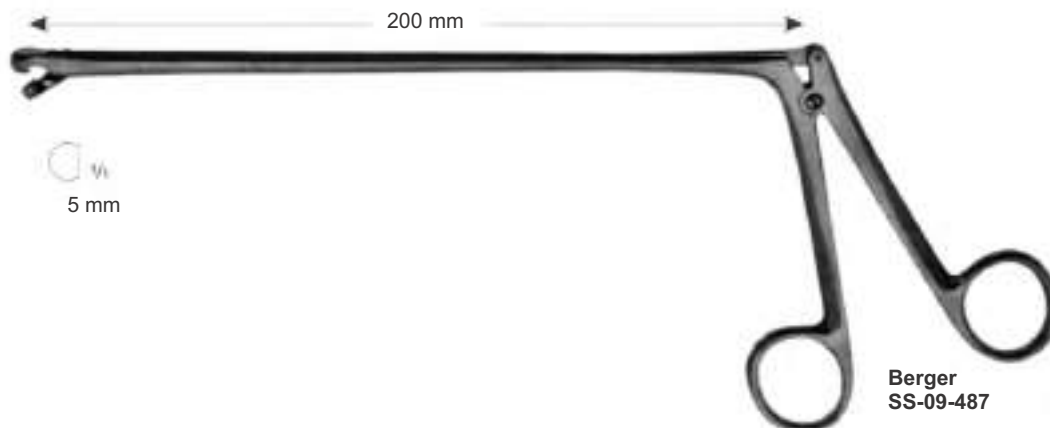
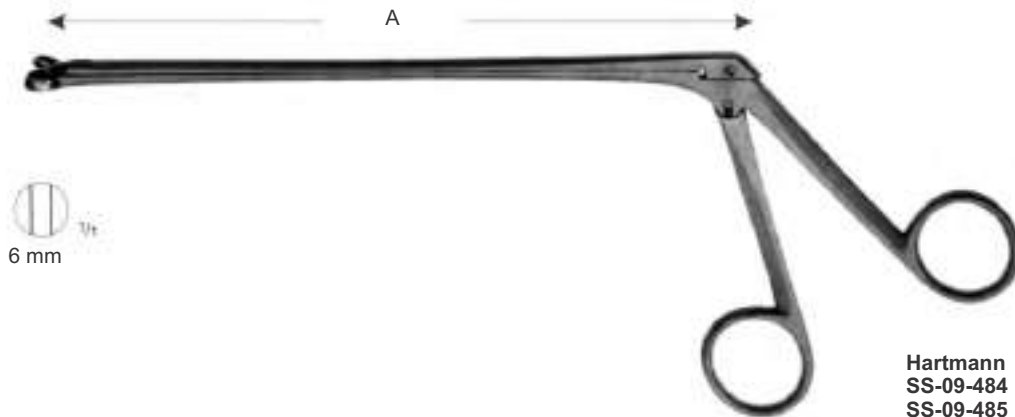



SAPTESTAR
Manufacturer & Exporter Of Surgical, Dental & Veterinary Instruments

Cervical Biopsy & Specimen Forceps
Pinzas saca-bocados para biopsia
Pincas emporte-pieces a biopsie

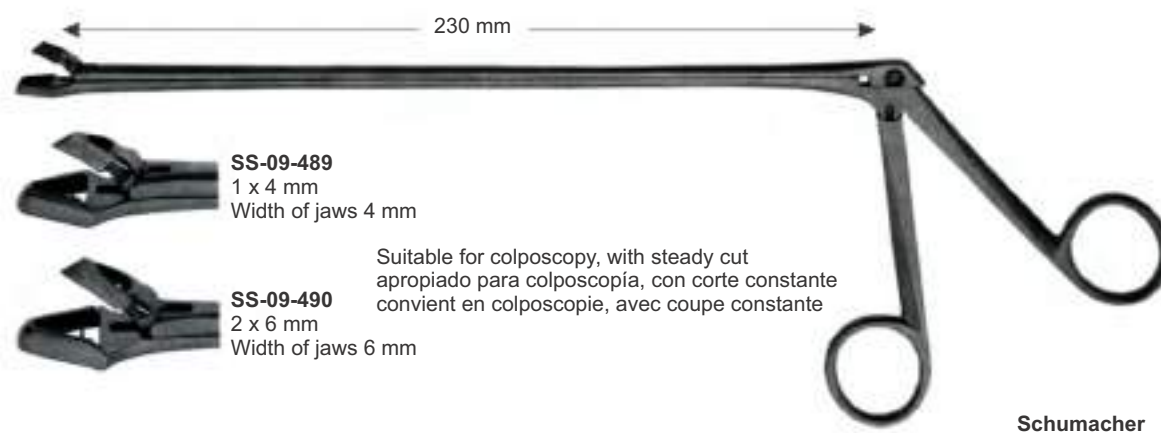
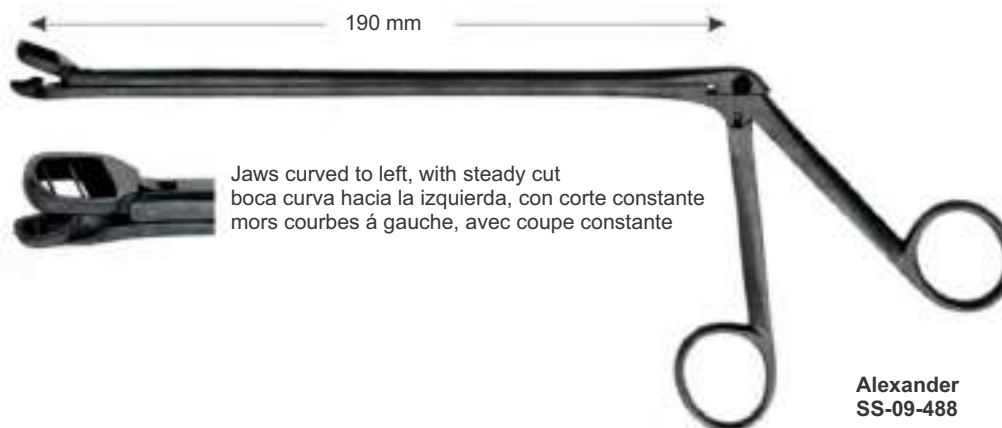

Cervical Biopsy & Specimen Forceps
Pinzas saca-bocados para biopsia
Pinces emporte-pieces a biopsie



Burke
SS-09-492 Shaft size 18 cm
SS-09-492A Shaft size 20 cm
SS-09-492B Shaft size 25 cm





SAPTESTAR
Manufacturer & Exporter Of Surgical, Dental & Veterinary Instruments

Cervical Biopsy & Specimen Forceps
Pinzas saca-bocados para biopsia
Pinces emporte-pieces a biopsie



SS-09-496
140 mm
Universal Handle
With complete



Huber
SS-09-497
140 mm
Universal Handle
With complete



Bruenings
SS-09-498 200 mm
SS-09-499 250 mm

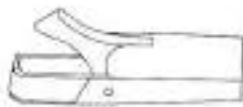

Townsendmini
SS-09-500

2.3 x 4.2 mm
straight

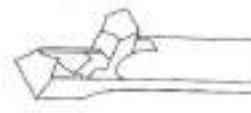

Tischler kevorkian
SS-09-501

3 x 9.5 mm
straight

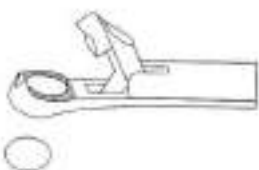

Baggish
SS-09-502

4 x 6.5 mm
straight

Cervical Biopsy & Specimen Forceps
Pinzas saca-bocados para biopsia
Pinces emporte-pieces a biopsie



4.6 mm / A
5.4 mm / B

SS-09-503

25 cm
complete
completo
complet

Tip only
Punta suelta
Embout, seul

Handle
mango
manche

Schumacher

A



3.7 x 5 mm

Townsend

SS-09-504

Straight
recta
droit



3.7 x 5 mm

Townsend

SS-09-505

angled upward
angulada hacia arriba
angulé au dessus



3.7 x 5 mm

Townsend

SS-09-505

angled downward
angulada hacia abajo
angulé au dessous



3 x 7 mm

Tischler

SS-09-507

Straight
recta
droit



3 x 7 mm

Tischler

SS-09-508

angled upward
angulada hacia arriba
angulé au dessus

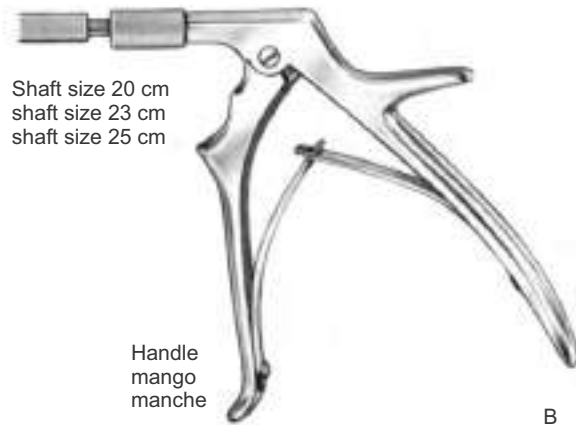

Shaft size 20 cm
shaft size 23 cm
shaft size 25 cm

Handle
mango
manche

B



3 x 7 mm

Tischler

SS-09-509

angled downward
angulada hacia abajo
angulé en dessous



3 x 8 mm / A
3 x 9 mm / B

Kevourkian-Younger

SS-09-510

straight
recta
droit

Obstetrical Forceps
Forceps obstetricos
Forceps obstetriques



Simpson-Braun
SS-10-101
31 cm



Simpson-Braun
SS-10-102
36 cm



Naegele
SS-10-103
35.5 cm



Naegele
SS-10-104
40 cm



Kieland
SS-10-105
41 cm



Kieland-Luikart
SS-10-106
41 cm



Bill
SS-10-107
Traction handle to be used with all forceps with standard type handle
Tractor adecuado para todas las fórceps con mango standard
Tracteurs pour tous les forceps avec manches ordinaires



Wrigley
SS-10-108
28 cm
Forceps for caesarean section
Fórceps para operación cesárea
Forceps pour césarienne



Piper
SS-10-109
44.5 cm
For delivery of the after coming head
in breech presentation
especialmente para partos en
presentación de nalgas
Spatules pour dégager la tête



Tarnier
SS-10-110
40 cm
Forceps with traction rod
Fórceps con dispositivo de tracción
Forceps avec dispositif de traction

Obstetrical Forceps
Forceps obstetricos
Forceps obstetriques



Sellheim
SS-10-111
32 cm
Obstetric lever
Separador para la salida de cabeza
Levier obstétrique



Green-Armytage
SS-10-112
20.5 cm
Caesarean section haemostatic forceps
Pinza-clamp uterina para hemostasis
Pince-clamp utérine pour hémostase



Willett
SS-10-113
19 cm
Scalp flap forceps
Pinza para pericráneo
Pince pour le cuir chevelu



Murless
SS-10-114
30 cm
Head extractor for use in lower segment in caesarean operation
Elevador para cabeza usándose en el segmento inferior del útero en casos de operaciones cesáreas
Levier á tête utilisé en cas de césarienne



SAPTESTAR
Manufacturer & Exporter Of Surgical, Dental & Veterinary Instruments

Placenta & Ovum Forceps
Pinzas para aborto y placenta
Pinces placentaires et pour poste-abortum



Winter

Without ratchet
sin cremallera
sans crémaillère



SS-10-116
28.5 cm



SS-10-117
28.5 cm



SS-10-118
28.5 cm



SS-10-119
28.5 cm



SS-10-120
28.5 cm



SS-10-121
28.5 cm



Winter

Without ratchet
sin cremallera
sans crémaillère

Placenta & Ovum Forceps
Pinzas para aborto y placenta
Pinces placentaires et pour poste-abortum



Without ratchet
sin cremallera
sans crémaillère



Saenger
SS-10-122
29 cm



With ratchet
con cremallera
avec crémaillère



Saenger
SS-10-123
27.5 cm



With ratchet
con cremallera
avec crémaillère



Saenger
SS-10-124
27.5 cm

Placenta & Ovum Forceps
Pinzas para aborto y placenta
Pinces placentaires et pour poste-abortum



14 mm



SS-10-125
14 mm

18 mm



SS-10-126
18 mm

21 mm



SS-10-127
21 mm

Cuzzi
SS-10-125 14 mm
SS-10-126 18 mm
SS-10-127 21 mm
30 cm

Placenta & ovum scoops
Cucharillas para aborto y placenta
Curettes à avortement et placenta

Placenta & Ovum Forceps
Pinzas para aborto y placenta
Pinces placentaires et pour poste-abortum



Bumm
SS-10-128 24 mm
SS-10-129 26 mm
SS-10-130 28 mm
 31 cm
 sharp, malleable
 cortantes, maleable
 trachentes, malléables

Bumm
SS-10-131 24 mm
SS-10-132 26 mm
SS-10-133 28 mm
 31 cm
 blunt, malleable
 romas, maleable
 mousses, malléables

Recamir
SS-10-134 35 mm
SS-10-135 40 mm
 33.5 cm
 Placenta and ovum curettes, blunts / rigid
 Curetas para aborto y placenta, romas / rigidas
 Curettes á avortement et placenta, mousse / rigide



SAPTESTAR

Manufacturer & Exporter Of Surgical, Dental & Veterinary Instruments



+92-340-4040061



exportsaptestar@gmail.com



info@saptestar.com



www.saptestar.com



Defence Road, Near Hotel Javson, 51310-Sialkot Pakistan





SAPTESTAR

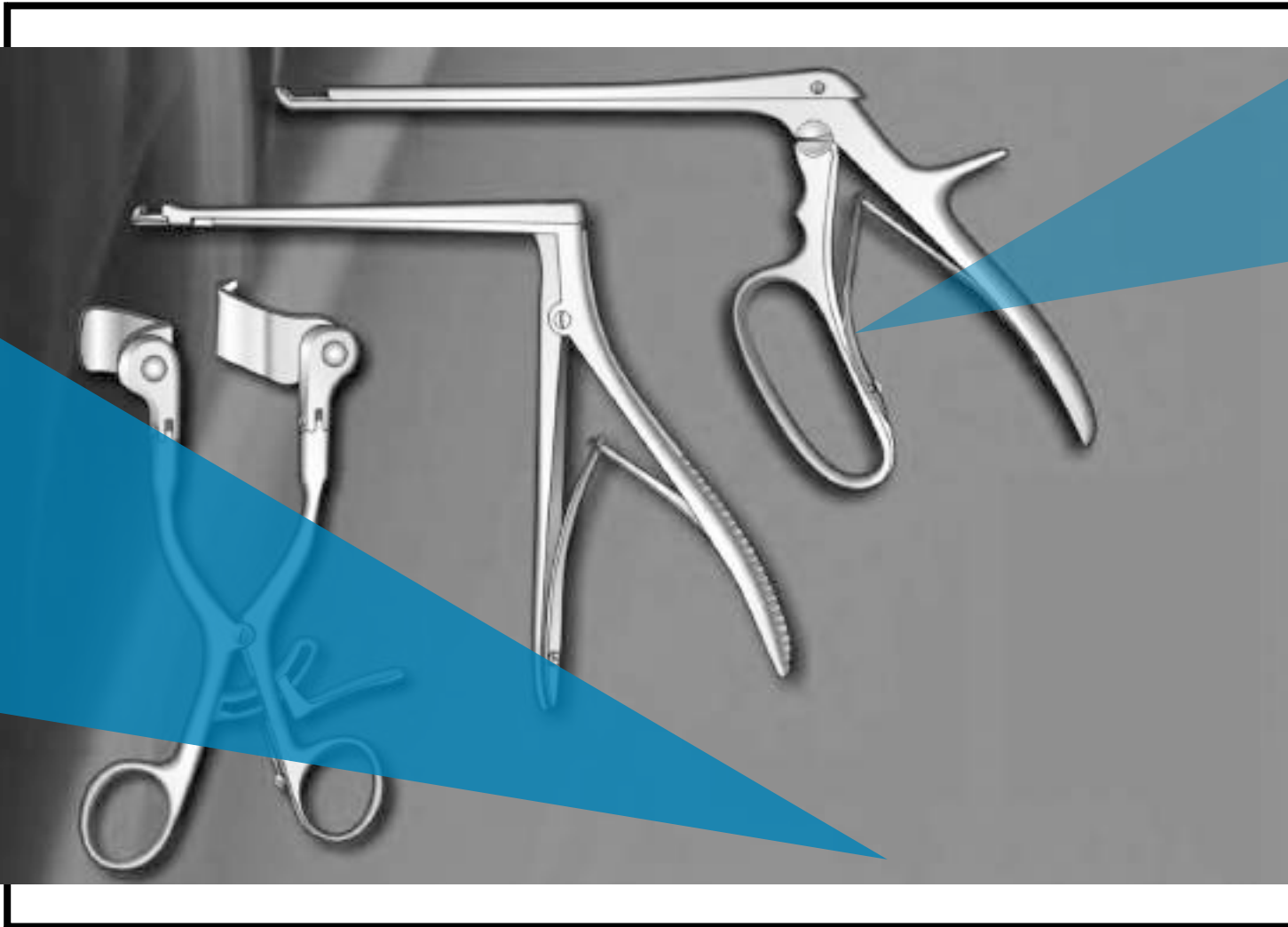

**Manufacturers & Exporters Of Quality Surgical Instruments
Neurosurgery Catalogue**

Group 11

Neurosurgery & Laminectomy 11

-  +92-340-4040061
-  exportsaptestar@gmail.com
-  info@saptestar.com
-  www.saptestar.com
-  Defence Road, Near Hotel Javson, 51310-Sialkot Pakistan

Company Profile



ABOUT US

Quality begins at **SapteStar** Instruments Company where master craftsmen forge and manufacture each instrument to its exact specifications and measurements. Instruments must undergo a series of quality control inspections in order to be worthy of **SapteStar** name and warranty. We offer a wide selection of medical instruments including Surgical and Dental instruments.

We have acquired a unique and unmatched understanding of manufacturing through a large experience, working since 1908. Years of experience & state of the art manufacturing facilities helped us to keep our prices low. Our Surgical & Dental instruments are created by expert craftsmen, providing unfaltering quality you can rely on.

We have launched a fully interactive website where you can get online and track your orders 24 hours a day, 7 days in a week, and 365 days a year. Ask for our free e-catalogue on CD-Rom to save time and enjoy hassle free ordering.

We provide our customers with most reliable customer service as your satisfaction is our top priority. Our customers always enjoy our wonderful customer service and quality tools at the best price.

Lastly we invite you to have a work experience with SapteStar Instruments Company and we will prove ourselves as one of the most valuable source you have.

You can find us at

SapteStar
CEO



Company Profile



History

SAPTESTAR INSTRUMENTS was founded in 1995. Our Great Grandfather **Mian Muhammad Fazal Elahi** was the founder of M/s M.F. Elahi & Company (E.P.) Pvt. Ltd, established in 1908. SapteStar is a sister concern of M.F. Elahi & Co. It is our pride to be a member of M.F. Elahi Family.

SapteStar Instruments Company is located in the heart of beautiful city, Sialkot, Pakistan. We are manufacturers and exporters of quality Surgical, Dental instruments and Scissors of all sorts in various categories. We are closely attached with highly skilled surgeons and other technicians of the surgical industry to make the new instruments development possible.

SapteStar is in a continues process of development and testing of new instruments for their precision and perfect functioning. We are also working at imported forging supply by foreign customers.

Certificates

Instruments Company has achieved the certificates for ISO-9001, ISO-13485, cGMP (FDA) and CE Marking.

Quality Control

All material use in the manufacturing of our instruments are tested from relevant laboratories. Our continuous quality control is our best warranty so that you built confidence in our products.

Deliveries

Deliveries are quick and in-time.

Mode Of Payment

Terms of Payment is ADVANCE or LETTER OF CREDIT (Irrevocable)

Company Profile



Quality Policy

SapteStar Instruments Company aims to produce quality Surgical, Dental instruments and Scissors of all sorts at reasonable prices to become an exemplary manufacturer. Our total emphasize is to achieve customer's satisfaction by clearly understanding their requirements and following a quality management system which is a primary concern of all our work force. We do our best to produce instruments of finest quality.

<p><i>Certificate of Registration</i></p>  <p>The Governing Board of Q.A. International Certification Limited hereby grants to:</p> <p>SPTSTAR INSTRUMENTS CO. Registration No. QAIC / PK / 1224 - B</p> <p><i>(Whereafter called the Registered Company) the right to be listed in the Directory of Registered Companies in respect of the services listed below. These services shall be offered by the Registered Company at or from only the address given below in accordance with the quality management system in compliance with the Requirements of ISO 13485:2016.</i></p> <p>Address to which this Certificate refers: Defence Road, Near Wapda Grid Station, Sialkot - Pakistan</p> <p>Approved Scope to which this Certificate refers: Manufacture of Non-Active Surgical and Dental Instruments <i>(Please note that the above scope represents the certified activity of the named organisation and as such, the organisation may undertake additional activities that are not covered under this certification).</i></p> <p>Signed for and on behalf of the Board</p>  <p>CHIEF EXECUTIVE SCHEME MANAGER</p> <p>Certificate Issue Date : 16th July 2018 - Certificate Renewal Before : 16th July 2019 Date of Initial Registration : 16th July 2018 - Re-Certification Before : 15th July 2020</p> <p>This Certificate of Registration is granted subject to the Regulations approved by the Board.</p> 	<p><i>Certificate of Registration</i></p>  <p>The Governing Board of Q.A. International Certification Limited hereby grants to:</p> <p>SPTSTAR INSTRUMENTS CO. Registration No. QAIC / PK / 1224 - A</p> <p><i>(Whereafter called the Registered Company) the right to be listed in the Directory of Registered Companies in respect of the services listed below. These services shall be offered by the Registered Company at or from only the address given below in accordance with the quality management system in compliance with ISO 9001:2015.</i></p> <p>Address to which this Certificate refers: Defence Road, Near Wapda Grid Station, Sialkot - Pakistan</p> <p>Approved Scope to which this Certificate refers: Manufacture of Surgical and Dental Instruments <i>(Please note that the above scope represents the certified activity of the named organisation and as such, the organisation may undertake additional activities that are not covered under this certification).</i></p> <p>Signed for and on behalf of the Board</p>  <p>CHIEF EXECUTIVE SCHEME MANAGER</p> <p>Certificate Issue Date : 16th July 2018 - Certificate Renewal Before : 16th July 2019 Date of Initial Registration : 16th July 2018 - Re-Certification Before : 15th July 2020</p> <p>This Certificate of Registration is granted subject to the Regulations approved by the Board.</p> 	<p>CERTIFICATE</p>  <p>Application of Council Directive 93/42/EEC as updated directive 2007/47/EC for Class I Medical Devices This is certifying that the products submitted are:</p> <p>CLASS I MEDICAL DEVICES (Re-Useable, Non-Powered Surgical and Dental Instruments)</p> <p>Registration No. DCS/9904155</p> <p>Manufactured By: SPTSTAR INSTRUMENTS CO. Defence Road, Near Wapda Grid Station, Sialkot-Pakistan</p> <p>Comply with the applicable requirements of the Directive 93/42/EEC as updated directive 2007/47/EC for Class I Medical Devices</p> <p>The Technical file of the products have been assessed according to the procedure of Conformity Assessment described in the Annex -I, Annex VII.</p> <p>Limitations: The manufacturer must inform DCS of any substantial changes occurred in the Product or process in order to examine whether this certificate remains valid. Conformance to all the regulatory requirements is the sole responsibility of the manufacturer including the appointment of EU Authorized Representative and registration with concerned competent authority.</p> <p>CHAIRMAN SCHEME MANAGER</p>  <p>Certificate Issue Date: June 20, 2018 Certificate Expiry Date: June 29, 2019</p>  <p>www.dcsincertification.org</p>
---	--	--

Warranty

All SapteStar Instruments are produced from finest stainless steel available to be free from any defect in material or workmanship. Any product that proves to be defective in material or workmanship will either be repaired or replaced without any charge. This warranty is void if the instrument is abused, altered, modified or is not used in the manner for which it is intended.



Neurosurgery & Laminectomy

11 neurosurgery & laminectomy

Beyer Laminectomy Punch	15	Micro Scissor Saw Edge	35
Caspar Blade	43	Micro Scissor Vannas Blade	35
Caspar Different Blade Size	42	Micro Scoop	06
Caspar For Cervical Retractor	41-40	Milligan	10
Caspar Retractor	40	Nicola	28
Caspar Rongeur	26	Oldberg Rongeur	27
Caspar Rongeur	27-26	Olivecrona (gigli)	01
Cervical Traction Tongs	Tongs03	Olivecrona Conves Spatule	14
Citelli Laminectomy Punch	15	Olivecrona Dissector	11
Cone Cranial Punch	02	Penfield Dissector	12
Crutchfield Cervical Traction	03	Ray Curette	04
Crutchfield Drill Point	03	Ray Pituitary Instruments	28
Cushing Decompression Hook	13	Sachs	10
Cushing Laminectomy Rongeur	23	Scoville Different Blade	43
Cushing Spatule	14	Scoville Haverfield Retractor	42
Dahlgren Cranial Rongeur	02	Scoville Nerve Root Retractor	13
Davis Brain Malleable Spatule	14	Scoville Only Frame	43
De Martel (Bailey)	01	Spurling Laminectomy Rongeur	24
De Vilbiss With Hook	02	Takahashi Rongeur	22
Fahlbusch	29-28	Taylor Blade	43
Ferris-Smith Cushing Rongeur	21	Toennis Dure Dissector	11
Ferris-Smith-Kerrison	16,17,20	Weil-blakesley	22
For Cervical Vertebra Column	40	Yasargil Ligature Guides	09
Frazier Dure Separator	10	Yasargil Pituitary Rongeur	27
Gigli Handle	01	Yasargil Raspatory	07,08
Hajek-kofler	19	Yasargil Scoop	07
Hardy Curette	04	Yasargil Vessel Knife	07
Hardy Fahlbusch	28		
Hardy	04,05,28-30		
Hardy-Fahlbusch	05		
Heifetz Spatule	14		
Holsher Root Retractor	13		
Horsley	10		
Jacobson Buttoned Probe	08		
Jacobson Suture Pusher	08		
Jacobson Twin Probe	08		
Jacobson Vessel Knife	08		
Kerrison Punch	15		
Koos Vessel Knife	07		
Kraus	07		
Landolt Reulen	29		
Landolt-Cushing Specula	04		
Love Nerve Root Retractor	13		
Love-gruenwald Rongeur	25		
Love-Kerrison (Colclough)	17		
Love-Kerrison(Colclough)	18-17		
Loyo Pituitary Instrument	31		
Loyo	31-34		
Mico Dissector	06		
Mico Raspatory	06		
Micro Forcep	38-37		
Micro Tumor Grasping Forcep	37		
Micro Dissector	09		
Micro Forcep Angled	37		
Micro Instrument Hook	06		
Micro Needle Holder	39		
Micro Raspatory	09		
Micro Scissor Angled Blade	36-35		

Instruments for Cranial Opening
Instrumentos para apertura craneana
Instruments pour l'ouverture du crane



Olivecrona (Gigli)

- SS-11-101** 25 cm
- SS-11-102** 30 cm
- SS-11-103** 40 cm
- SS-11-104** 50 cm
- SS-11-105** 60 cm
- SS-11-106** 70 cm

Wire saws
Sierras de hilo
Fils-scies



GIGLI
SS-11-107
7 cm

Hook handles for wire saws, 1 pair
Mango con gancho, para sierras de hilo, 1 par
Poignees pour scies, 1 paire



DE MARTEL (BAILEY)
SS-11-108
33 cm

Conductor for wire saws
Conductor para sierras de hilo
Conducteur pour scies

Cranial Rongeur Forceps
Pinzas saca-bocado craneal
Rongeurs craniens



SS-11-112



SS-11-110



SS-11-113



Dahlgren
SS-11-109
20 cm
Cranial rongeur with 2 hooks (SS-11-110)
Pinza saca-bocado craneal con
2 ganchos (SS-11-110)
Rongeur craniens avec 2 crochets
(SS-11-110)



DE Vilbiss
SS-11-111
20.5 cm
Cranial rongeur with 1 hook each small
(SS-11-112) & large (SS-11-113)
Pinza saca-bocado craneal con 1 gancho
pequeno (SS-11-112) y grande (SS-11-113)
Rongeur craniens avec 1 crochets petit
(SS-11-112) et grand (SS-11-113)



Cone
SS-11-114
22.5 cm
Cranial punch rongeur for
maximum of 12 mm of bone
Pinza saca-bocados craneal
para craneo hasta 12 mm
Pince cranienne jusqu'a 12 mm
epaissens du crane

Traction Tongs
 Pinzas de traccion craneal
 Pinces de traction cranienne



**Crutchfield
 SS-11-115**
 ø 3.5 mm
 Drill point for crutchfield
 cervical traction tongs

Perforador inicial para pinzas de
 traccion craneal Crutchfield

Alesoir pour etrier traction cranienne
 de Crutchfield



**Crutchfield
 SS-11-116**
 ø 5 mm
 Drill point for crutchfield
 cervical traction tongs

Perforador inicial para pinzas de
 traccion craneal Crutchfield

Alesoir pour etrier traction cranienne
 de Crutchfield



150 mm

**Crutchfield
 SS-11-117**
 Cervical Traction Tongs, small size
 Pinzas de traccion craneal, tamaño pequeno
 Etrier traction cranienne, petit modele



155 mm

**Crutchfield
 SS-11-118**
 Cervical Traction Tongs, medium size
 Pinzas de traccion craneal, tamaño mediano
 Etrier traction cranienns, modele moyen



Spare pin
 punta de repuesto
 pointe de rechange seule

175 mm

SS-11-119
 Cervical Traction Tongs, for extension of the neck vertebrae,
 large size, pins adjustable hence no initial drilling

Pinza de traccion craneal para la extension de las vertebrae de cuello,
 tamaño grande, puntas ajustables suprimiendo perforaciones iniciales

Etrier traction cranienne, pour l'extension des vertebrae cervicales, grand
 modele, mandrins reglabes supprimant la perforation initiale

Pituitary Instruments
Instrumentos para la hipofisectomia
Instruments pour la hypophysectomie



Landolt-Cushing
SS-11-120 Ø 15 mm x 70 mm
SS-11-121 Ø 15 mm x 90 mm

Specula for trans-sphenoidal hypophysectomy

Especulos para la hipofisectomia trans-sfenoidal

Specula pour la hypophysectomie transsphenoidale



4 mm Ø

6 mm Ø

4 mm Ø

4 mm Ø

4 mm Ø

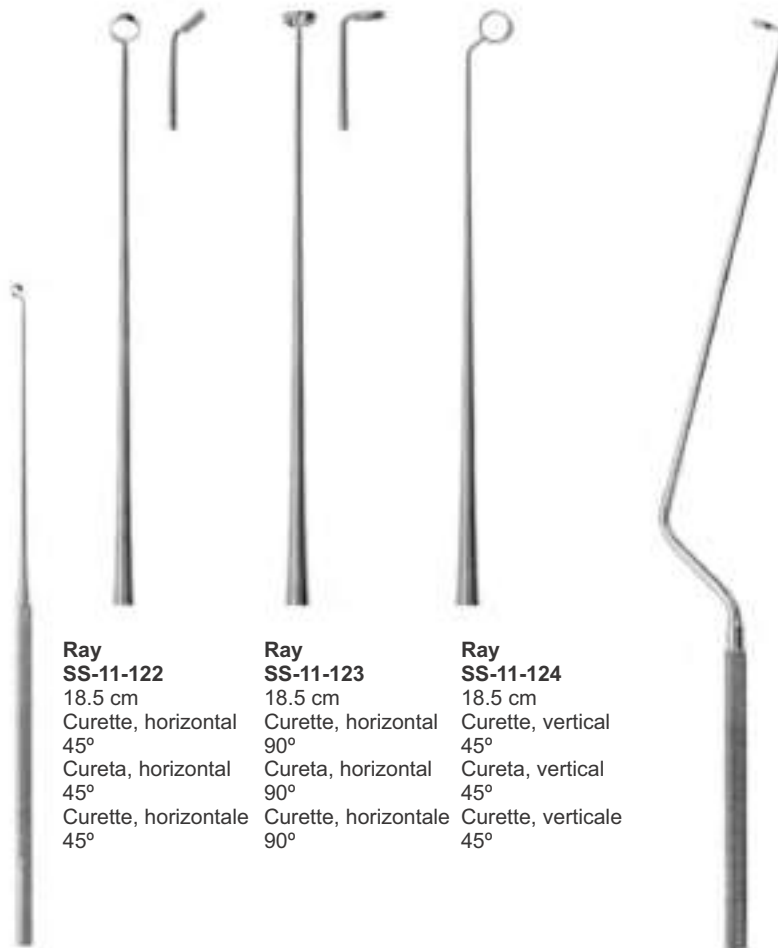

Ray
SS-11-122
18.5 cm
Curette, horizontal 45°
Cureta, horizontal 45°
Curette, horizontale 45°

Ray
SS-11-123
18.5 cm
Curette, horizontal 90°
Cureta, horizontal 90°
Curette, horizontale 90°

Ray
SS-11-124
18.5 cm
Curette, vertical 45°
Cureta, vertical 45°
Curette, verticale 45°



Hardy
SS-11-125
26 cm
Curette, horizontal 90°, malleable
Cureta, horizontal 90°, maleable
Curette, horizontale 90°, malleable

Hardy
SS-11-126
26 cm
Curette, horizontal 90°, malleable
Cureta, horizontal 90°, maleable
Curette, horizontale 90°, malleable

Pituitary Instruments
Instrumentos para la hipofisectomia
Instruments pour la hypophysectomie



**Hardy
SS-11-127**
24.5 cm
Enucleators,
blunt

Enucleadores
romos,
Enucleateurs,
moux

**Hardy
SS-11-128**
24.5 cm
Enucleators,
blunt

Enucleadores
romos,
Enucleateurs,
moux

**Hardy-
Fahlbusch
SS-11-129**
24.5 cm
Dissectors,
sharpened
inner edge

Disecadorea,
agudos
en el interior
Dissecteur,
pointus a
l' intereur

**Hardy-
Fahlbusch
SS-11-130**
24.5 cm
Dissectors,
sharpened
inner edge

Disecadorea,
agudos
en el interior
Dissecteur,
pointus a
l' intereur

**Hardy
SS-11-131**
24.5 cm
Dissectors,
sharpened
inner edge

Disecadorea,
agudos
en el interior
Dissecteur,
pointus a
l' intereur

**Hardy
SS-11-132**
24.5 cm
Dissectors,
sharpened
inner edge

Disecadorea,
agudos
en el interior
Dissecteur,
pointus a
l' intereur

**Hardy
SS-11-133**
24.5 cm
Implant fork

Horquilla para
implantar
Fourchette pour
implants

Micro Instruments
 Instrumentos para microcirugia
 Instruments pour microchirurgie



SS-11-134
 23 cm
 Hook
 Gancho
 Crochet



SS-11-135
 23 cm
 Hook
 Gancho
 Crochet



SS-11-136
 23 cm
 Dissector
 Disecador
 Dissecteur



SS-11-137
 23 cm
 Dissector
 Disecador
 Dissecteur



SS-11-138
 23 cm
 Raspatory
 Legra
 Rugine-raspatoire



SS-11-139
 23 cm
 Raspatory
 Legra
 Rugine-raspatoire



SS-11-140
 23 cm
 Scoop
 Cucharilla cortante
 Curette tranchante



SS-11-141
 23 cm
 Scoop
 Cucharilla cortante
 Curette tranchante



**Yasargil
 SS-11-142**
 18.5 cm
 Raspatory
 Legra
 Rugine-raspatoire

**Yasargil
 SS-11-143**
 18.5 cm
 Raspatory
 Legra
 Rugine-raspatoire

**Yasargil
 SS-11-144**
 18.5 cm
 Raspatory
 Legra
 Rugine-raspatoire

**Yasargil
 SS-11-145**
 18.5 cm
 Scoop
 Cucharilla cortante
 Curette tranchante

**Yasargil
 SS-11-146**
 18.5 cm
 Vessel Knife
 Cuchillo para vasos
 Couteau pour vaisseaux

**Yasargil
 SS-11-147**
 18.5 cm
 Vessel Knife
 Cuchillo para vasos
 Couteau pour vaisseaux



**Koos
 SS-11-148**
 18.5 cm
 Vessel Knife
 Cuchillo para vasos
 Couteau pour vaisseaux

**Koos
 SS-11-149**
 18.5 cm
 Vessel Knife
 Cuchillo para vasos
 Couteau pour vaisseaux

**Koos
 SS-11-150**
 18.5 cm
 Vessel Knife
 Cuchillo para vasos
 Couteau pour vaisseaux

**Koos
 SS-11-151**
 18.5 cm
 Vessel Knife
 Cuchillo para vasos
 Couteau pour vaisseaux

**Kraus
 SS-11-152**
 18.5 cm
 Vessel Knife
 Cuchillo para vasos
 Couteau pour vaisseaux

Lateral cutting edge
 filo de corte lateral
 tranchant lateral

Micro Instruments
Instrumentos para microcirugia
Instruments pour microchirurgie



**Jacobson
SS-11-153**
18.5 cm
Buttoned probe
Sonda abotonada
Sonde boutonnee



**Jacobson
SS-11-154**
18.5 cm
Twin probe
Sonda doble
Sonde double



**Jacobson
SS-11-155**
18.5 cm
Suture pusher
Empujador de sutura
Fourche a fill



**Yasargil
SS-11-156**
18.5 cm
Raspatory
Legra
Rugine-raspatoire



**Yasargil
SS-11-157**
18.5 cm
Dissector
Dissecteur



**Yasargil
SS-11-158**
18.5 cm
Raspatory
Legra
Rugine-raspatoire



**Yasargil
SS-11-159**
18.5 cm
Raspatory
Legra
Rugine-raspatoire



**Yasargil
SS-11-160**
18.5 cm
Raspatory
Legra
Rugine-raspatoire



**Jacobson
SS-11-161**
18.5 cm
Vessel Knife
Cuchillo para vasos
Couteau pour vaisseaux



SS-11-162
 23 cm
 Dissector
 Disecador
 Dissecteur

SS-11-163
 23 cm
 Dissector
 Disecador
 Dissecteur

SS-11-164
 23 cm
 Raspatory
 Legra
 Rugine-raspatoire

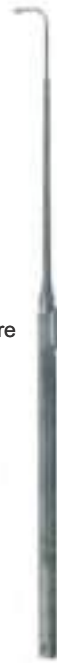

Yasargil



SS-11-165
 18.5 cm

SS-11-166
 18.5 cm

SS-11-167
 18.5 cm

SS-11-168
 18.5 cm

Ligature guides & carriers, probe pointed
 Guia-ligadura, abotonada
 passe-fils, boutonnes

Dura Separators
 Disecadores de dura-madre
 Dissecteurs pour la dure-mere

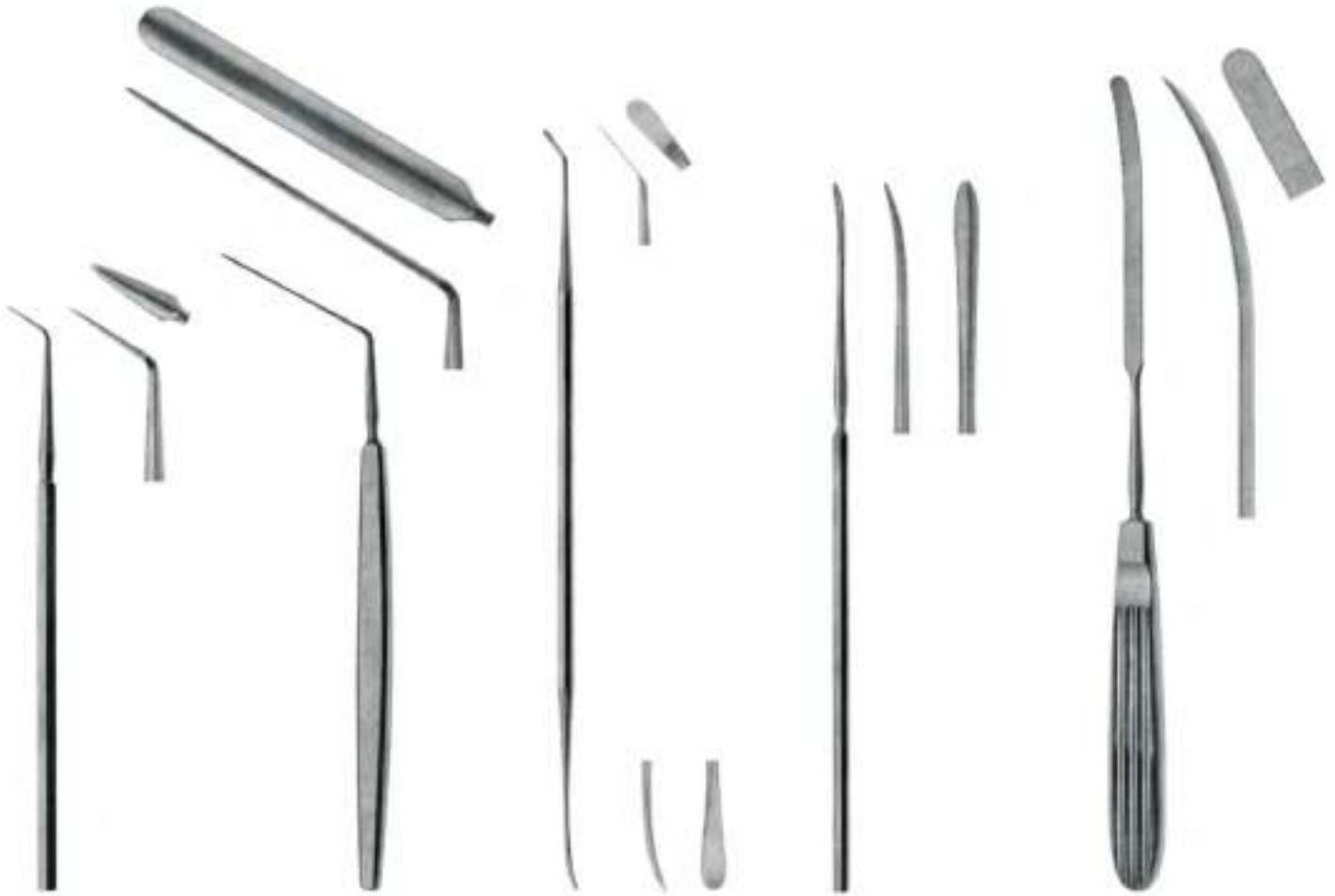

Frazier
SS-11-169
 16.5 cm

Horsley
SS-11-170
 18.5 cm

Milligan
SS-11-171
 21 cm

Sachs
SS-11-172
 20 cm

Sachs
SS-11-173
 23 cm

Dura Dissectors
Disecadores para dura-madre
Dissecteurs a dure-mere



Toennis
SS-11-174
24 cm



Toennis
SS-11-175
24 cm



Olivecrona
SS-11-176 18 cm
SS-11-177 24 cm



Olivecrona
SS-11-178 19.5 cm
SS-11-179 24.0 cm

Dura Dissectors
 Disecadores para dura-madre
 Dissecteurs a dure-mere

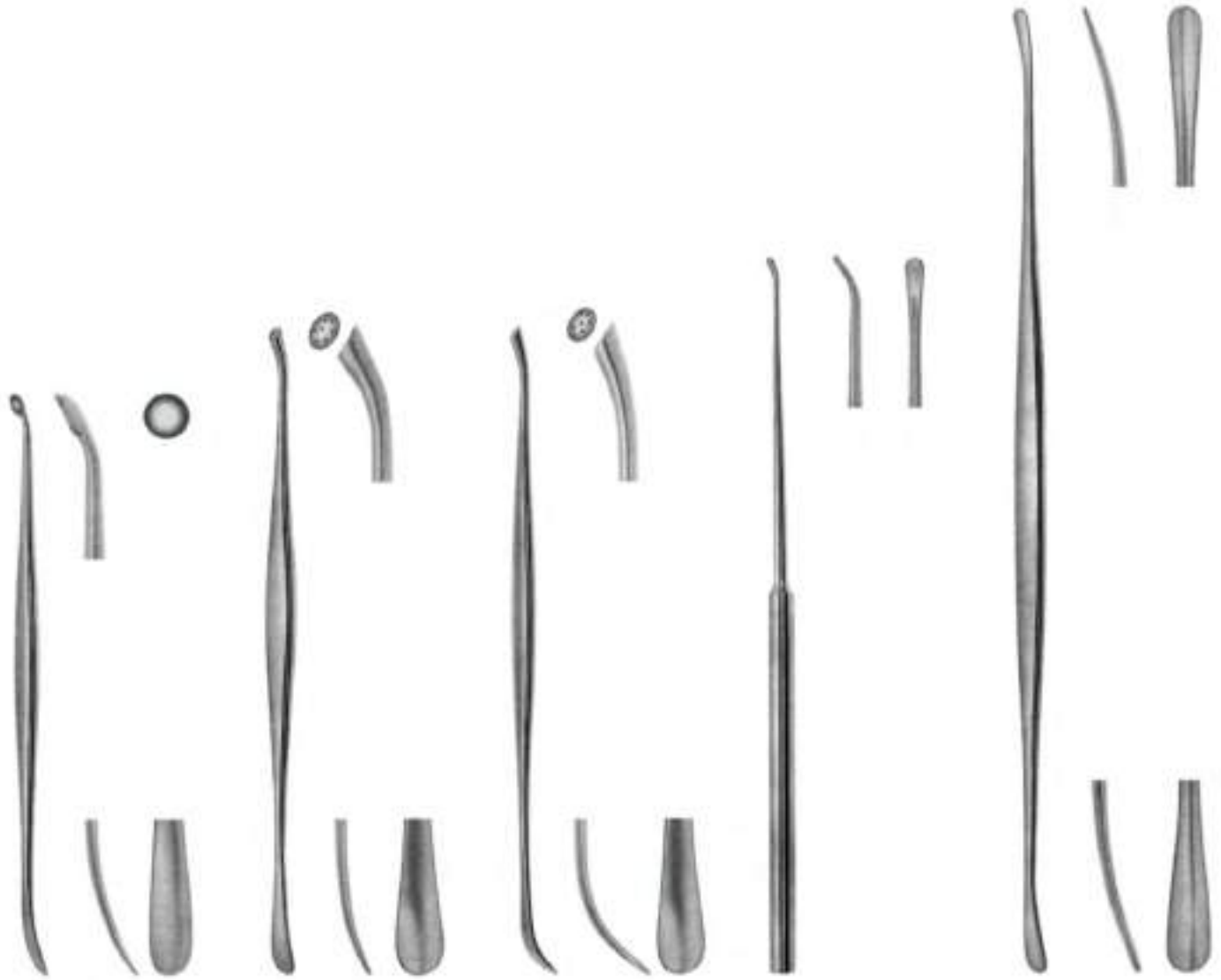

Penfield
SS-11-180
 17.5 cm

Penfield
SS-11-181
 19.5 cm

Penfield
SS-11-182
 19.5 cm

Penfield
SS-11-183
 21.5 cm

Penfield
SS-11-184
 29 cm



SAPTESTAR
Manufacturer & Exporter Of Surgical, Dental & Veterinary Instruments

Retractors
Separadores
Retracteurs

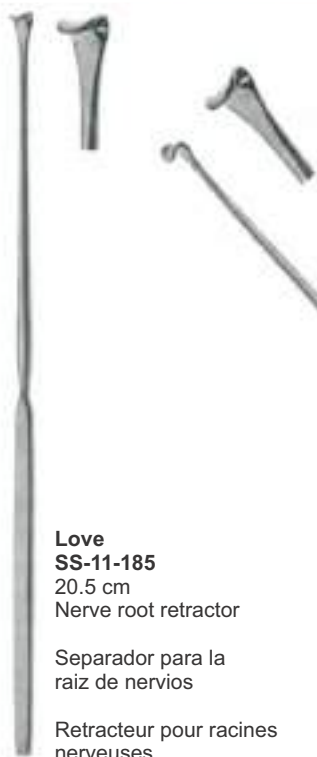

Love
SS-11-185
20.5 cm
Nerve root retractor

Separador para la
raiz de nervios

Retracteur pour racines
nerveuses



Love
SS-11-186
18 cm
Nerve root retractor

Separador para la
raiz de nervios

Retracteur pour racines
nerveuses

Love
SS-11-187
14 cm
Nerve root retractor

Separador para la
raiz de nervios

Retracteur pour
racines nerveuses

Love
SS-11-188
22.5 cm
Nerve root retractor

Separador para la
raiz de nervios

Retracteur pour racines
nerveuses



Scoville
SS-11-189
23 cm
Nerve root retractor

Separador para la
raiz de nervios

Retracteur pour racines



Holsher
SS-11-190
24 cm
Nerve root retractor

Separador para la
raiz de nervios

Retracteur pour racines



Scoville
SS-11-191
20 cm
Nerve root retractor

Separador para la
raiz de nervios

Retracteur pour racines



Cushing
SS-11-192
21 cm
Decompression hook
Gancho para decompression
Crochet pour decompression

Brain Spatulas
Espatulas cerebrales
Spatules cerebrales



Davis
SS-11-193 13 mm x 190 mm
SS-11-194 16 mm x 190 mm
malleable
maleables
malleables



Cushing
SS-11-195
10 + 12 mm x 195 mm



Heifetz
SS-11-196 8 mm x 155 mm
SS-11-197 11 mm x 155 mm
SS-11-198 14 mm x 155 mm
SS-11-199 17 mm x 155 mm
malleable
maleables
malleables



Heifetz
SS-11-200 14 mm x 200 mm
SS-11-201 17 mm x 200 mm
SS-11-202 20 mm x 200 mm
malleable
maleables
malleables

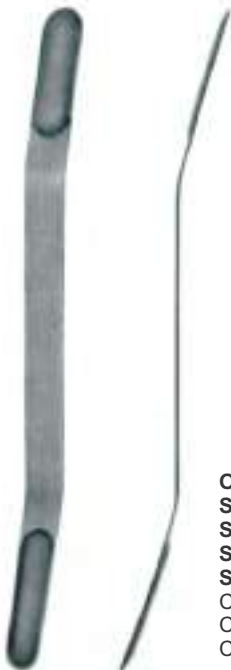

Olivecrona
SS-11-203 7 + 9 mm x 180 mm
SS-11-204 11 + 13 mm x 180 mm
SS-11-205 15 + 18 mm x 180 mm
SS-11-216 19 + 21 mm x 180 mm
Convex
Convexas
Convexes

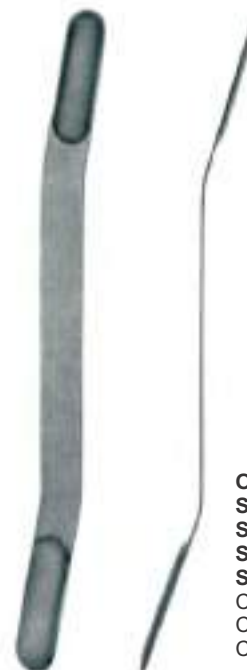

Olivecrona
SS-11-207 7 + 9 mm x 180 mm
SS-11-208 11 + 13 mm x 180 mm
SS-11-209 15 + 18 mm x 180 mm
SS-11-210 19 + 21 mm x 180 mm
Concave
Concavas
Concaves



SAPTESTAR
 Manufacturer & Exporter Of Surgical, Dental & Veterinary Instruments

Laminectomy Punches
 Pinzas cortantes para laminectomia
 Pinces emporte-piece a laminectomie



SS-11-211
2 mm

SS-11-212
3 mm

Citelli
 upwards cutting 90°
 cortante hacia arriba 90°
 coupant vers le haut 90°



SS-11-213
2 mm

Beyer
SS-11-213
 upwards cutting 90°
 cortante hacia arriba 90°
 coupant vers le haut 90°



SS-11-214	3 mm	90 mm
SS-11-215	4 mm	90 mm
SS-11-216	5 mm	90 mm
SS-11-217	6 mm	90 mm

width of bite Length of shaft
 Anchura de la boca Longitud del vastago
 Largeur des mors Longueur de la tige



Kerrison
 upwards cutting 90°
 cortante hacia arriba 90°
 coupant vers le haut 90°

Laminectomy Punches
Pinzas cortantes para laminectomia
Pinces emporte-pièce a laminectomie

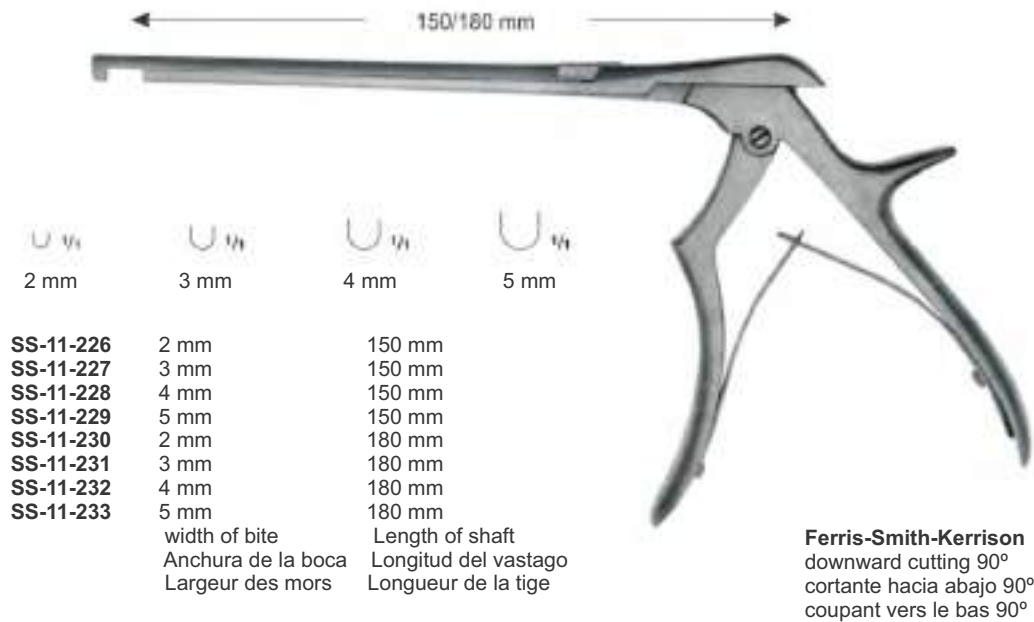
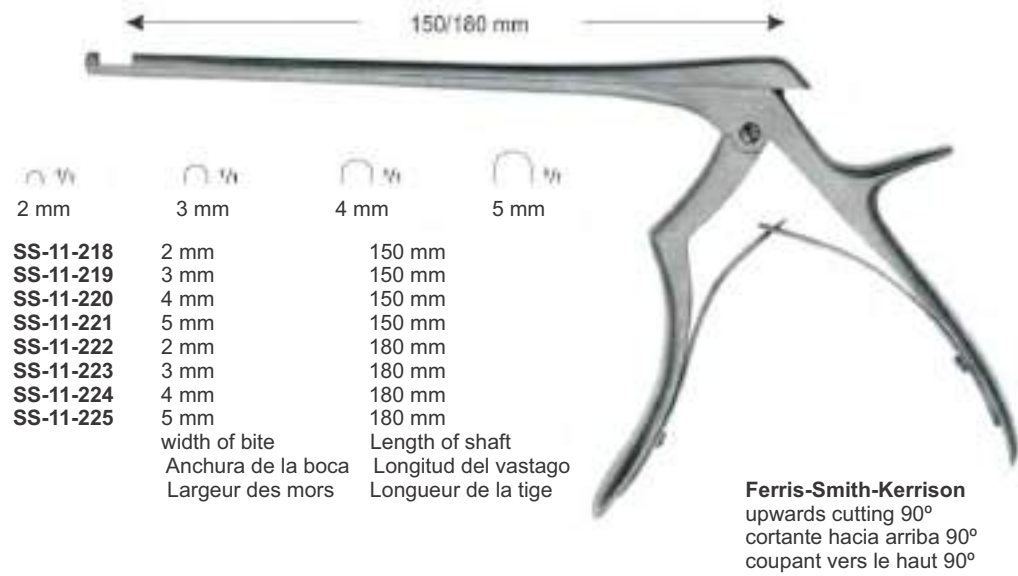



SAPTESTAR
 Manufacturer & Exporter Of Surgical, Dental & Veterinary Instruments

Laminectomy Punches
 Pinzas cortantes para laminectomia
 Pincas emporte-piece a laminectomie

150/180/200 mm

2 mm 3 mm 4 mm 5 mm

SS-11-234	2 mm	150 mm
SS-11-235	3 mm	150 mm
SS-11-236	4 mm	150 mm
SS-11-237	5 mm	150 mm
SS-11-238	2 mm	180 mm
SS-11-239	3 mm	180 mm
SS-11-240	4 mm	180 mm
SS-11-241	5 mm	180 mm
SS-11-242	2 mm	200 mm
SS-11-243	3 mm	200 mm
SS-11-244	4 mm	200 mm
SS-11-245	5 mm	200 mm

width of bite Length of shaft
 Anchura de la boca Longitud del vastago
 Largeur des mors Longueur de la tige

Ferris-Smith-Kerrison
 upwards cutting 130°
 cortante hacia arriba 130°
 coupant vers le haut 130°

150/200 mm

3 mm 5 mm

SS-11-246	3 mm	150 mm
SS-11-247	5 mm	150 mm
SS-11-248	3 mm	200 mm
SS-11-249	5 mm	200 mm

width of bite Length of shaft
 Anchura de la boca Longitud del vastago
 Largeur des mors Longueur de la tige

Love-Kerrison (Colclough)
 upwards cutting 90°
 cortante hacia arriba 90°
 coupant vers le haut 90°

Laminectomy Punches
Pinzas cortantes para laminectomia
Pinces emporte-piece a laminectomie

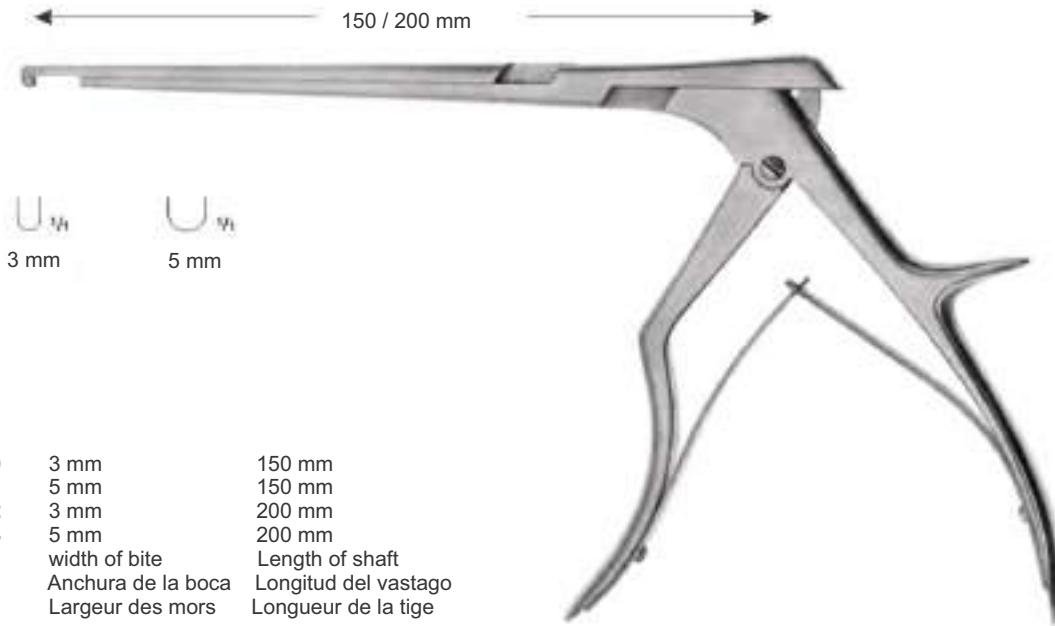

SS-11-250	3 mm	150 mm
SS-11-251	5 mm	150 mm
SS-11-252	3 mm	200 mm
SS-11-253	5 mm	200 mm
	width of bite	Length of shaft
	Anchura de la boca	Longitud del vastago
	Largeur des mors	Longueur de la tige

Love-Kerrison (Colclough)
downwards cutting 90°
cortante hacia abajo 90°
coupant vers le bas 90°

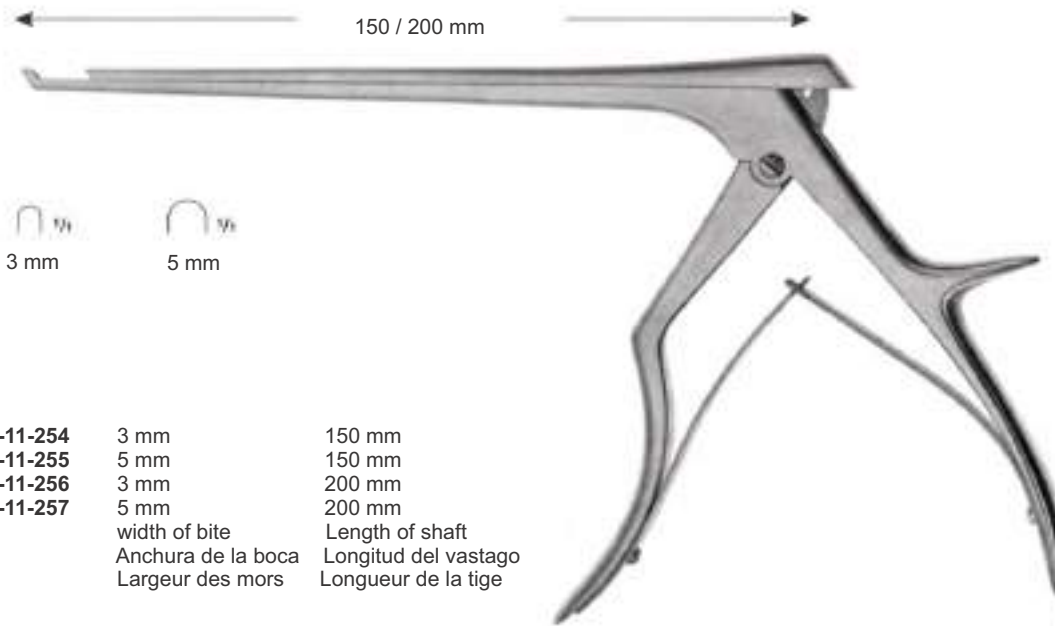

SS-11-254	3 mm	150 mm
SS-11-255	5 mm	150 mm
SS-11-256	3 mm	200 mm
SS-11-257	5 mm	200 mm
	width of bite	Length of shaft
	Anchura de la boca	Longitud del vastago
	Largeur des mors	Longueur de la tige

Love-Kerrison (Colclough)
upwards cutting 130°
cortante hacia arriba 130°
coupant vers le haut 130°

Laminectomy Punches
 Pinzas cortantes para laminectomia
 Pinces emporte-pièce a laminectomie

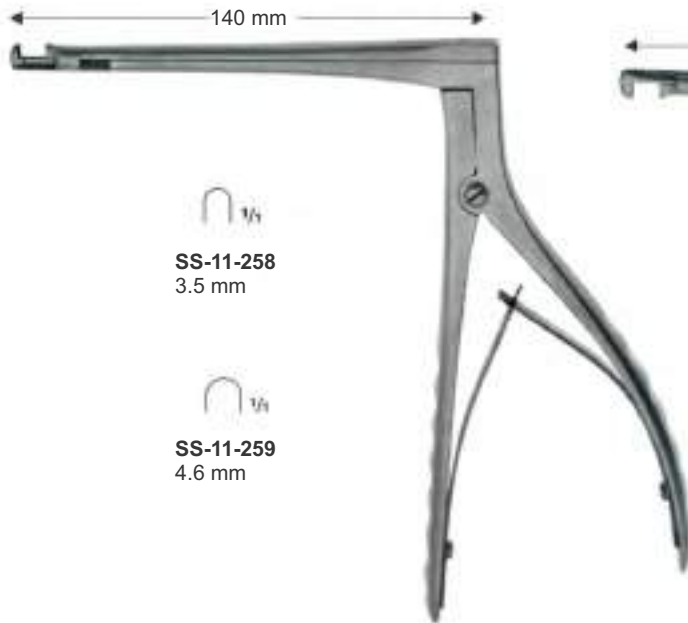

SS-11-258
 3.5 mm

SS-11-259
 4.6 mm

Hajek-Kofler
 upwards cutting 90°
 cortante hacia arriba 90°
 coupant vers le haut 90°



SS-11-260
 3.5 mm

SS-11-261
 4.6 mm

Hajek-Kofler
 upwards cutting 90°
 cortante hacia arriba 90°
 coupant vers le haut 90°

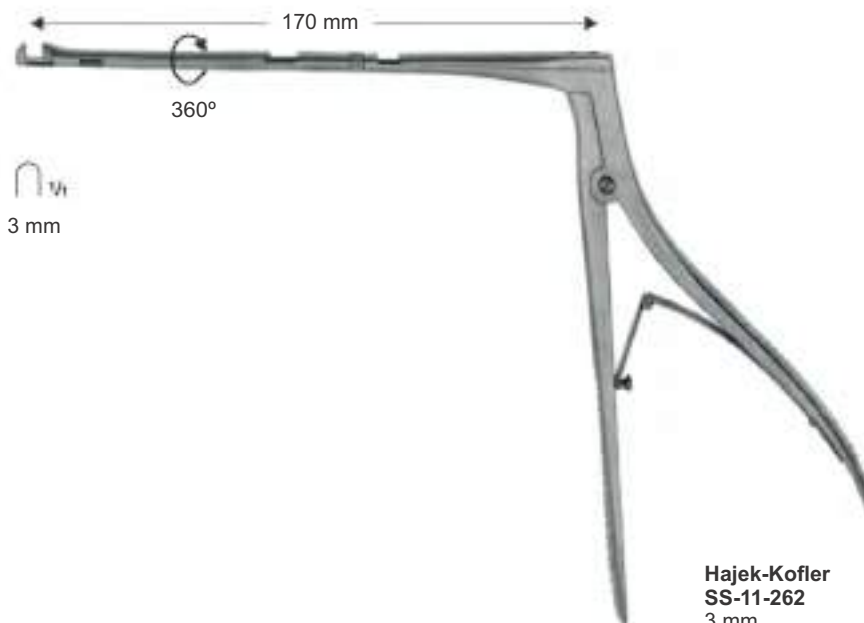

3 mm

Hajek-Kofler
SS-11-262
 3 mm
 90° cutting, shaft rotates 360°
 corte 90°, vastago girable 360°
 coupant a 90°, tige tournant 360°

Laminectomy Punches
Pinzas cortantes para laminectomia
Pinces emporte-piece a laminectomie

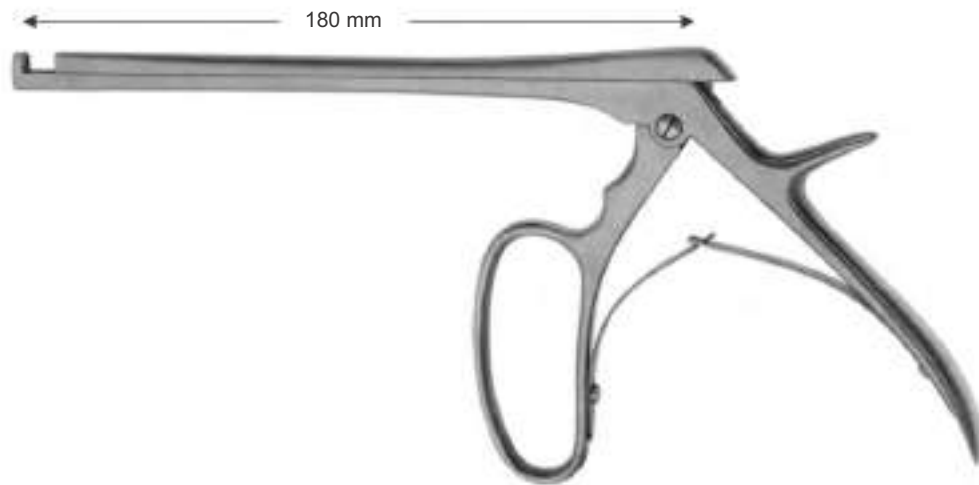

SS-11-263
3 mm



SS-11-264
5 mm

Ferris-Smith-Kerrison
upwards cutting 90°
cortante hacia arriba 90°
coupant vers le haut 90°



SS-11-265
3 mm



SS-11-266
5 mm

Ferris-Smith-Kerrison
downwards cutting 90°
cortante hacia abajo 90°
coupant vers le bas 90°



SS-11-267
3 mm



SS-11-268
5 mm

Ferris-Smith-Kerrison
upwards cutting 130°
cortante hacia arriba 130°
coupant vers le haut 130°

Laminectomy Rongeurs
 Pinzas cortantes para laminectomia
 Pincas emporte-pièce a laminectomie

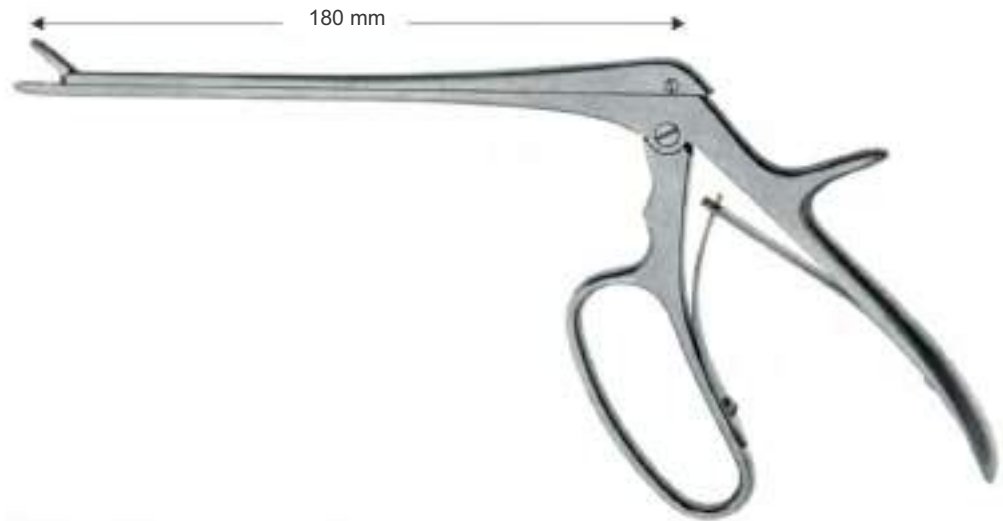

SS-11-269
 2 x 10 mm



SS-11-270
 3 x 10 mm



SS-11-271
 4 x 10 mm

Ferris-Smith-Cushing
 straight
 recta
 droits



SS-11-272
 2 x 10 mm



SS-11-273
 3 x 10 mm



SS-11-274
 4 x 10 mm

Ferris-Smith-Kerrison
 curved on flat
 curva hacia arriba
 courbure vers le haut



SS-11-275
 2 x 10 mm



SS-11-276
 3 x 10 mm



SS-11-277
 4 x 10 mm

Ferris-Smith-Kerrison
 curved down
 curva hacia abajo
 courbure vers le bas

Laminectomy Rongeurs
Pinzas cortantes para laminectomia
Pinces emporte-piece a laminectomie



BS-11-278
2.5 x 5 mm

BS-11-279
3.6 x 8 mm

BS-11-280
4.8 x 12 mm

Weil-Blakesley
straight
recta
droits

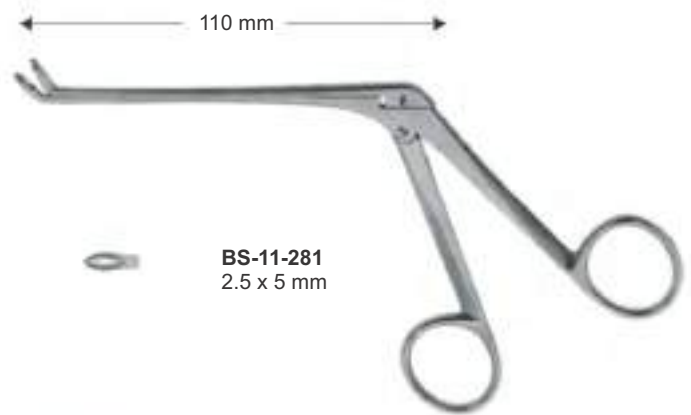

BS-11-281
2.5 x 5 mm

BS-11-282
3.6 x 8 mm

BS-11-283
4.8 x 12 mm

Weil-Blakesley
curved on flat
curva hacia arriba
courbure vers le haut



3 x 10 mm

Takahashi
SS-11-284
3 x 10 mm
straight
recta
droits



3 x 10 mm

Takahashi
SS-11-285
3 x 10 mm
curved on flat
curva hacia arriba
courbure vers le haut

Laminectomy Rongeurs
 Pinzas cortantes para laminectomia
 Pinces emporte-pièce a laminectomie



Cushing



2 x 10 mm

SS-11-286	2 x 10 mm	130 mm
SS-11-287	2 x 10 mm	150 mm
SS-11-288	2 x 10 mm	180 mm
straight	Anchura de la boca	Longitud del vastago
recta	Largeur des mors	Longueur de la tige
droits	Larghezza del morso	Lunghezza dell' asta



2 x 10 mm

SS-11-289	2 x 10 mm	130 mm
SS-11-290	2 x 10 mm	150 mm
SS-11-291	2 x 10 mm	180 mm
curved on flat	Size of jaw	length of shaft
curva hacia arriba	Anchura de la boca	Longitud del vastago
courbure vers le haut	Largeur des mors	Longueur de la tige



2 x 10 mm

SS-11-292	2 x 10 mm	130 mm
SS-11-293	2 x 10 mm	150 mm
SS-11-294	2 x 10 mm	180 mm
curved down	Size of jaw	length of shaft
curva hacia abajo	Anchura de la boca	Longitud del vastago
courbure vers le bas	Largeur des mors	Longueur de la tige

Laminectomy Rongeurs
Pinzas cortantes para laminectomia
Pinces emporte-pièce a laminectomie



Spurling

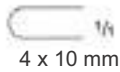

SS-11-295	4 x 10 mm	130 mm
SS-11-296	4 x 10 mm	150 mm
SS-11-297	4 x 10 mm	180 mm
straight	Size of jaw	length of shaft
recta	anchura de la boca	Longitud del vastago
droits	Largeur des mors	Longeue de la tige

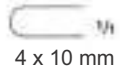

SS-11-298	4 x 10 mm	130 mm
SS-11-299	4 x 10 mm	150 mm
SS-11-300	4 x 10 mm	180 mm
curved on flat	Size of jaw	length of shaft
curva hacia arriba	anchura de la boca	Longitud del vastago
courbure vers le haut	Largeur des mors	Longeue de la tige

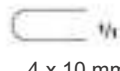

SS-11-301	4 x 10 mm	130 mm
SS-11-302	4 x 10 mm	150 mm
SS-11-303	4 x 10 mm	180 mm
curved down	Size of jaw	length of shaft
curva hacia abajo	Anchura de la boca	Longitud del vastago
courbure vers le bas	Largeur des mors	Longeue de la tige

Laminectomy Rongeurs
 Pinzas cortantes para laminectomia
 Pincas emporte-pièce a laminectomie

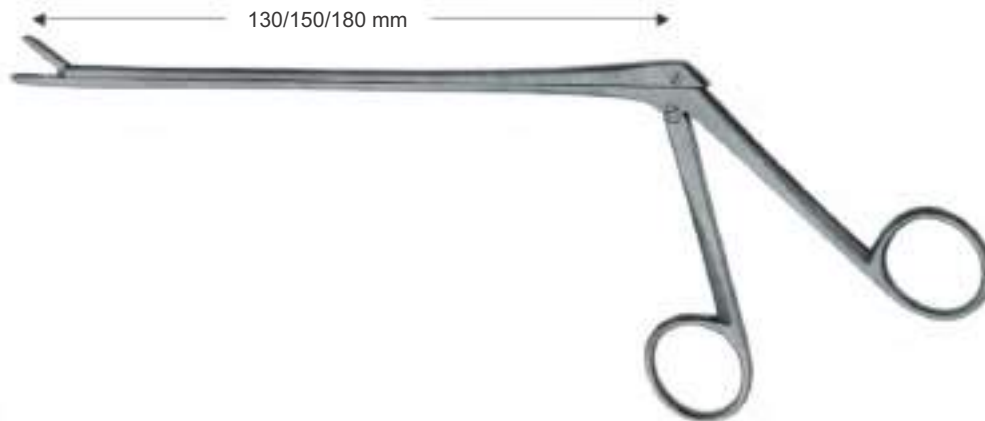

Love-Gruenwald



3 x 10 mm

SS-11-304	3 x 10 mm	130 mm
SS-11-305	3 x 10 mm	150 mm
SS-11-306	3 x 10 mm	180 mm
straight	Size of jaw	length of shaft
recta	Anchura de la boca	Longitud del vastago
droits	Largeur des mors	Longueur de la tige



3 x 10 mm

SS-11-307	3 x 10 mm	130 mm
SS-11-308	3 x 10 mm	150 mm
SS-11-309	3 x 10 mm	180 mm
curved on flat	Size of jaw	length of shaft
curva hacia arriba	Anchura de la boca	lonitud del vastago
courbure vers le haut	Largeur des mors	longueur de la tige



3 x 10 mm

SS-11-310	3 x 10 mm	130 mm
SS-11-311	3 x 10 mm	150 mm
SS-11-312	3 x 10 mm	180 mm
curved down	Size of jaw	length of shaft
curva hacia abajo	Anchura de la boca	Longitud del vastago
courbure vers le bas	Largeur des mors	Longueur de la tige

Laminectomy Rongeurs
Pinzas cortantes para laminectomia
Pincas emporte-piece a laminectomie

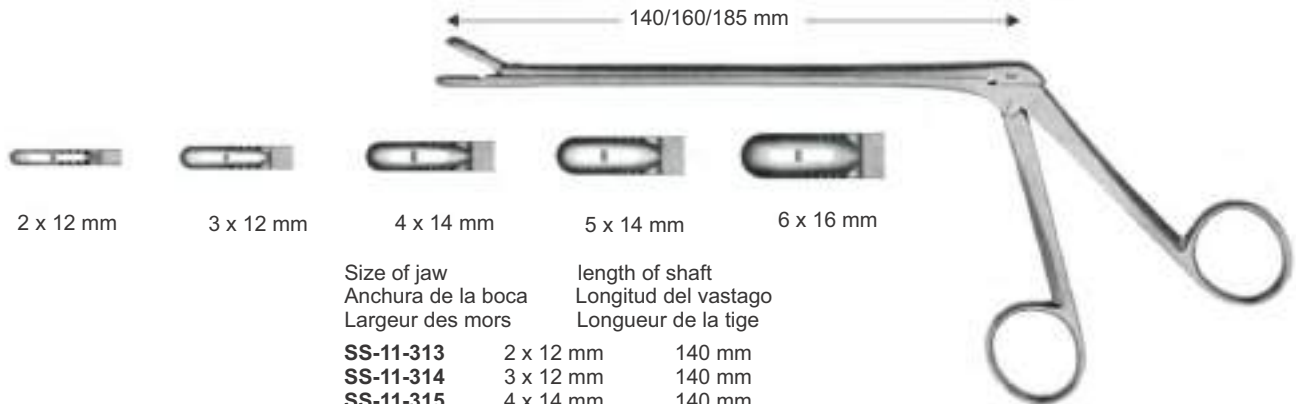

	Size of jaw Anchura de la boca Largeur des mors	length of shaft Longitud del vastago Longueur de la tige
SS-11-313	2 x 12 mm	140 mm
SS-11-314	3 x 12 mm	140 mm
SS-11-315	4 x 14 mm	140 mm
SS-11-316	5 x 14 mm	140 mm
SS-11-317	6 x 16 mm	140 mm
SS-11-318	2 x 12 mm	160 mm
SS-11-319	3 x 12 mm	160 mm
SS-11-320	4 x 14 mm	160 mm
SS-11-321	5 x 14 mm	160 mm
SS-11-322	6 x 16 mm	160 mm
SS-11-323	2 x 12 mm	185 mm
SS-11-324	3 x 12 mm	185 mm
SS-11-325	4 x 14 mm	185 mm
SS-11-326	5 x 14 mm	185 mm
SS-11-327	6 x 16 mm	185 mm

Caspar
straight
recta
droits



	Size of jaw Anchura de la boca Largeur des mors	length of shaft Longitud del vastago Longueur de la tige
SS-11-328	3 x 12 mm	140 mm
SS-11-329	4 x 14 mm	140 mm
SS-11-330	5 x 14 mm	140 mm
SS-11-331	3 x 12 mm	160 mm
SS-11-332	4 x 14 mm	160 mm
SS-11-333	5 x 14 mm	160 mm
SS-11-334	3 x 12 mm	185 mm
SS-11-335	4 x 14 mm	185 mm
SS-11-336	5 x 14 mm	185 mm

Caspar
curved on flat
curva hacia arriba
courbure vers le haut



SAPTESTAR
 Manufacturer & Exporter Of Surgical, Dental & Veterinary Instruments

Laminectomy Rongeurs
 Pinzas cortantes para laminectomia
 Pinces emporte-piece a laminectomie

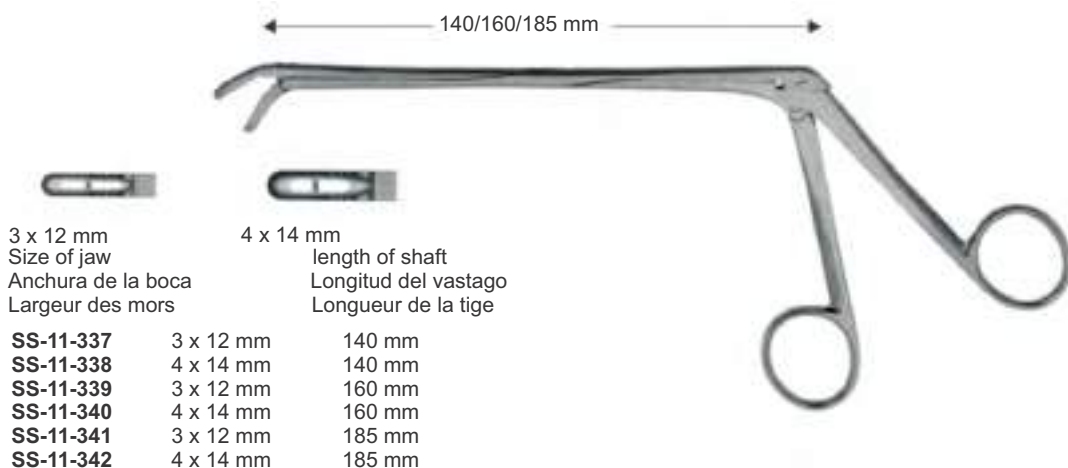

Caspar
 curved down
 curva hacia abajo
 courbure vers le bas



Yasargil
SS-11-343
 3.5 mm
 Pituitary rongeur
 Pinza para hipofisis
 Pince pour l'hypophyse



Oldberg
SS-11-344
 6 mm
 Pituitary rongeur
 Pinza para hipofisis

Pituitary Instruments
Instrumentos para la hipofisectomia
Instruments pour la hypophysectomie



Horizontal **SS-11-345**
Vertical **SS-11-346**

Ray
Ø 4 mm
18 cm



Ø mm
4 **SS-11-347**
6 **SS-11-348**

Hardy
26 cm



Nicola
SS-11-349
Ø 6.5 mm
21.5 cm



Nicola
SS-11-350
Ø 6.5 mm
21.5 cm



SS-11-351
enucleador, blunt
rechts right

Hardy
24.5 cm



SS-11-352
enucleador, sharp
rechts right



SS-11-353
enucleador, sharp
rechts right



SS-11-354
implat fork
24.5 mm



SS-11-355
Dissector
24.5 cm



SS-11-356
Dissector
24.5 cm

Hardy Fahlbusch



SAPTESTAR
 Manufacturer & Exporter Of Surgical, Dental & Veterinary Instruments

Pituitary Instruments
 Instrumentos para la hipofisectomia
 Instruments pour la hypophysectomie



3 SS-11-357
 5 SS-11-358
 Ø mm

Hardy
 24 cm
 angled up



3 SS-11-359
 5 SS-11-360
 Ø mm

Hardy
 24 cm
 angled down



Hardy
 24.5 cm
 tip width



Landolt
 SS-11-361
 26 cm
 malleable



Landolt
 SS-11-362
 26 cm
 malleable



Landolt
 SS-11-363
 26 cm
 malleable



Landolt
 SS-11-364
 26 cm
 malleable



Hosobuchi
 SS-11-365
 26 cm
 malleable



Fahlbusch
 SS-11-366
 26 cm
 Ø 2.5 mm



Landolt Reulen
 SS-11-367
 Ø 2.2 mm
 SS-11-368
 26 cm



SS-11-369
 Ø 2.5 mm



SS-11-370
 2 mm



SS-11-371
 1.7 mm

Pituitary Instruments
 Instrumentos para la hipofisectomia
 Instruments pour la hypophysectomie



3 SS-11-372
 5 SS-11-373
 Ø mm

Hardy
 24 cm
 right



3 SS-11-374
 5 SS-11-375
 Ø mm

Hardy
 24 cm
 left



Left SS-11-376
 Right SS-11-377

Hardy
 24 cm
 Ø 5 mm



Hardy
 SS-11-378
 23.5 cm
 bayonet



SS-11-379
 21 cm
 bayonet



23 cm
 curved



SS-11-380



SS-11-381



SS-11-382



SS-11-383

Pituitary Instruments
 Instrumentos para la hipofisectomia
 Instruments pour la hypophysectomie

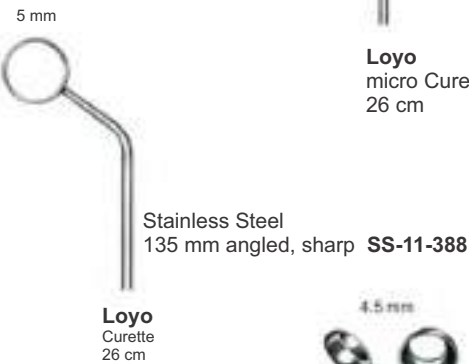
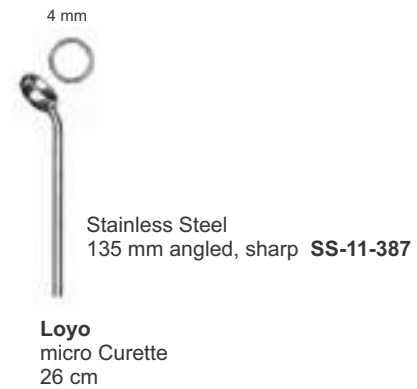

Pituitary Instruments
Instrumentos para la hipofisectomia
Instruments pour la hypophysectomie



5 mm

Stainless Steel
135 mm sharp upw, left **SS-11-391**

Loyo
Curette
26 cm

5 mm



Stainless Steel
135 mm sharp upw, right **SS-11-392**

Loyo
Curette
26 cm



Stainless Steel
135 mm blunt left **SS-11-393**

Loyo
Curette
26 cm



5 x 4 mm

Stainless Steel
135 mm blunt, angled **SS-11-394**

Loyo
Curette
26.5 cm



5 x 4 mm

Stainless Steel
135 mm blunt, right **SS-11-395**

Loyo
Curette
26 cm



1/2

Pituitary Instruments
Instrumentos para la hipofisectomia
Instruments pour la hypophysectomie

Loyo
micro chisel



for sella turcica

Stainless Steel
SS-11-396

Loyo
26 cm
pituitary dissector



135 mm right

Stainless Steel
SS-11-397

Loyo
26 cm
pituitary dissector



135 mm

Stainless Steel
SS-11-398

Loyo
26 cm
pituitary dissector



135 mm

Stainless Steel
SS-11-399

Loyo
26 cm
pituitary hook



135 mm

Stainless Steel
SS-11-400

Loyo
26 cm
pituitary elevator



135 mm left

Stainless Steel
SS-11-401

Loyo
26 cm
pituitary elevator



135 mm right

Stainless Steel
SS-11-402

Loyo
pituitary mirror



125 mm

Stainless Steel
SS-11-403

Pituitary Instruments
Instrumentos para la hipofisectomia
Instruments pour la hypophysectomie

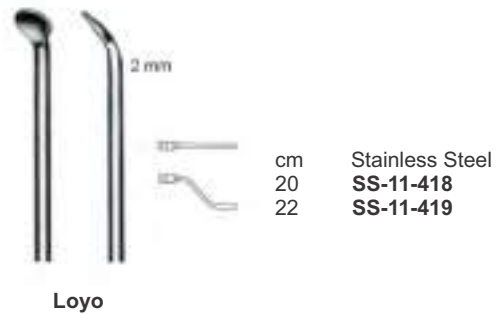
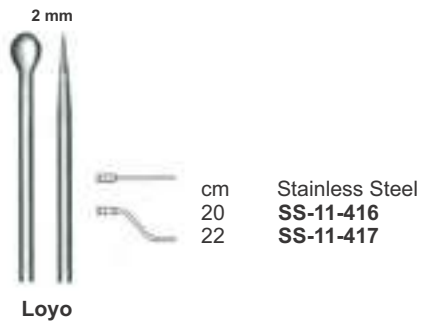
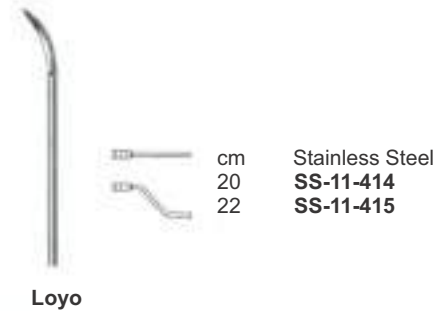
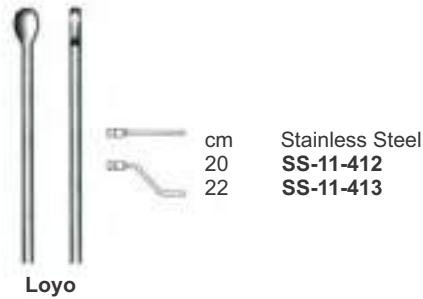
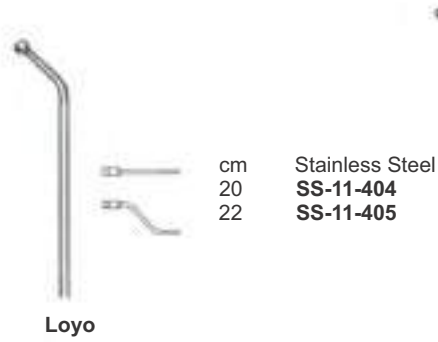

Micro-Scissors
 Micro-Tijeras
 Micro-Ciseaux



cm		
16	SS-11-420	SS-11-421
18	SS-11-422	SS-11-423
20	SS-11-424	SS-11-425
22.5	SS-11-426	SS-11-427
24	SS-11-428	SS-11-429



cm		
16	SS-11-430	SS-11-431
18	SS-11-432	SS-11-433
20	SS-11-434	SS-11-435
22.5	SS-11-436	SS-11-437
24	SS-11-438	SS-11-439



Vannas blade



cm		
16	SS-11-440	SS-11-441
18	SS-11-442	SS-11-443
20	SS-11-444	SS-11-445
22.5	SS-11-446	SS-11-447
24	SS-11-448	SS-11-449

Saw edge



cm		
16	SS-11-450	
18	SS-11-451	
20	SS-11-452	
22.5	SS-11-453	
24	SS-11-454	

Vannas blade angled over the blade

Micro-Scissors

Micro-Scissors
Micro-Tijeras
Micro-Ciseaux

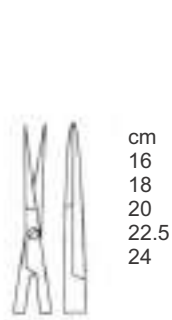

cm
16
18
20
22.5
24

SS-11-455
SS-11-457
SS-11-459
SS-11-461
SS-11-463



SS-11-456
SS-11-458
SS-11-460
SS-11-462
SS-11-464

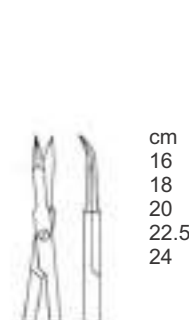

cm
16
18
20
22.5
24

SS-11-465
SS-11-467
SS-11-469
SS-11-471
SS-11-473



SS-11-466
SS-11-468
SS-11-470
SS-11-472
SS-11-474

Vannas blade



Micro-Scissors

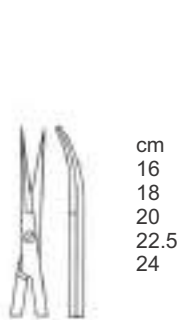

cm
16
18
20
22.5
24

SS-11-475
SS-11-477
SS-11-479
SS-11-481
SS-11-483



SS-11-476
SS-11-478
SS-11-480
SS-11-482
SS-11-484

Saw edge

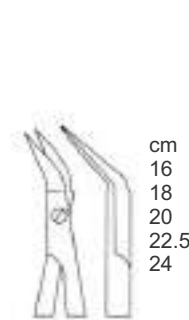

cm
16
18
20
22.5
24

SS-11-485
SS-11-486
SS-11-487
SS-11-488
SS-11-489

Vannas blade
angled over the
blade



125°
angled blade

cm
16
18
20
22.5
24

SS-11-490
SS-11-491
SS-11-492
SS-11-493
SS-11-494

Micro-Forceps
Micro-Pinzas
Micro-Pinces



cm
16
18
20
22.5
24



SS-11-495
SS-11-497
SS-11-499
SS-11-501
SS-11-503



SS-11-496
SS-11-498
SS-11-500
SS-11-502
SS-11-504



cm
16
18
20
22.5
24



SS-11-505
SS-11-506
SS-11-507
SS-11-508
SS-11-509

Angled



Micro forceps



cm
16
18
20
22.5
24

SS-11-510
SS-11-511
SS-11-512
SS-11-513
SS-11-514

4 x 2 teeth



cm
16
18
20
22.5
24

SS-11-515
SS-11-516
SS-11-517
SS-11-518
SS-11-519

Tumor grasping

Micro-Needle Holder
Micro-Porta-agujas
Micro-Porte-aiguilles



Micro needle holder
BCthout ratchet



cm	
16	SS-11-545
18	SS-11-546
20	SS-11-547
22.5	SS-11-548
24	SS-11-549



cm		
16	SS-11-550	SS-11-551
18	SS-11-552	SS-11-553
20	SS-11-554	SS-11-555
22.5	SS-11-556	SS-11-557
24	SS-11-558	SS-11-559



cm	
16	SS-11-560
18	SS-11-561
20	SS-11-562
22.5	SS-11-563
24	SS-11-564



cm		
16	SS-11-565	SS-11-566
18	SS-11-567	SS-11-568
20	SS-11-569	SS-11-570
22.5	SS-11-571	SS-11-572
24	SS-11-573	SS-11-574



Micro needle holder
without ratchet

Retractors For Cervical Vertebral Column
 Separadores para la columna cervical
 Ecarteurs pour colonne vertebrale



Caspar
SS-11-575
 complete
SS-11-576
 Only 12 cm
 opening 12 cm

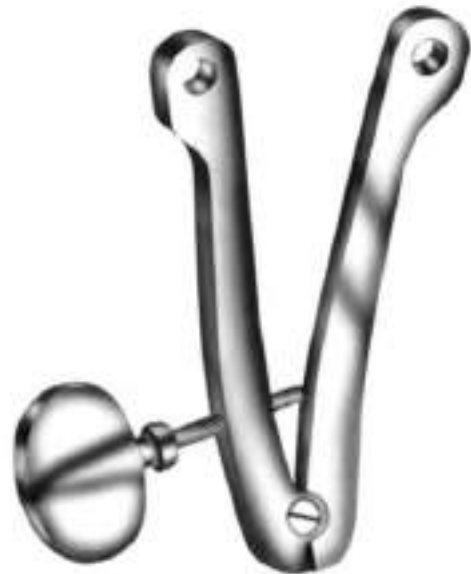

Caspar
SS-11-577
 complete 2 x 5 blades



Caspar
SS-11-578
 complete
SS-11-579
 without blades



Caspar
 Mm
 45 x 23
 50 x 23
 55 x 23
 60 x 23
 65 x 23



Caspar
 mm
 40 x 23
 45 x 23
 50 x 23
 55 x 23
 60 x 23

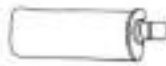

mm
 45 x 20
 50 x 20
 55 x 20
 60 x 20
 65 x 20



Caspar
SS-11-580
 complete
SS-11-581
 without blades



Caspar
 mm
 40 x 23
 45 x 23
 50 x 23
 55 x 23
 60 x 23

Retractors For Cervical Vertebral Column
 Separadores para la columna cervical
 Ecarteurs pour colonne vertebrale

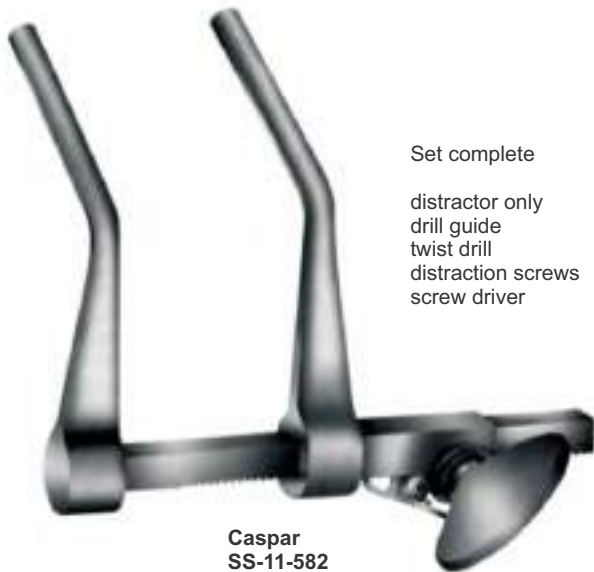

Caspar
SS-11-582
 Left

Set complete
 distractor only
 drill guide
 twist drill
 distraction screws
 screw driver



Caspar
SS-11-582
 Right

Set complete
 distractor only
 drill guide



Caspar
SS-11-584
 Complete
 Only

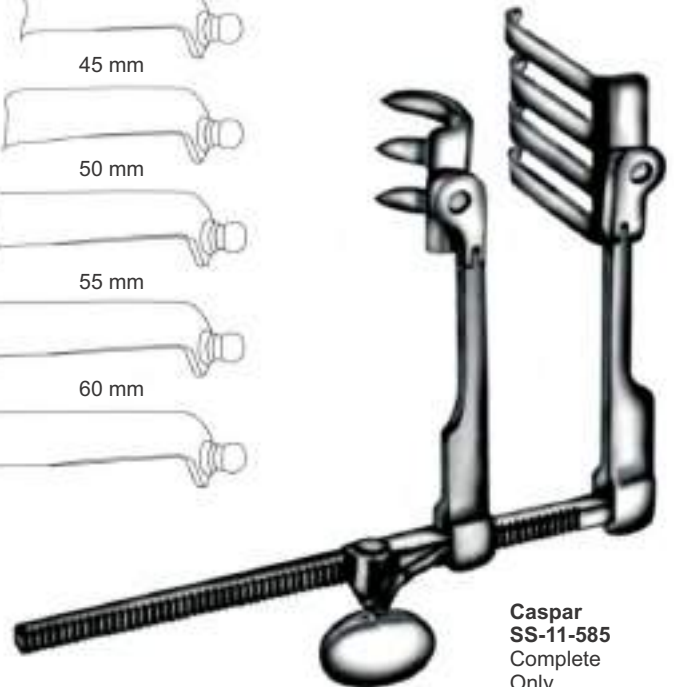
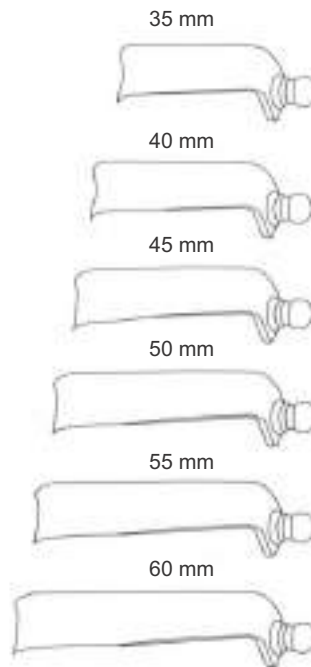

Caspar
SS-11-585
 Complete
 Only



SAPTESTAR
Manufacturer & Exporter Of Surgical, Dental & Veterinary Instruments

Retractors For Cervical Vertebral Column
Separadores para la columna cervical
Ecarteurs pour colonne vertebrale



Scoville Haverfield
SS-11-586
Only frame



Caspar
SS-11-587
complete
SS-11-588
Only frame



Caspar
SS-11-589
50 mm



Caspar
SS-11-590
70 mm



Caspar
35 mm x 22
40 mm x 22
45 mm x 22
50 mm x 22
55 mm x 22
60 mm x 22
65 mm x 22
70 mm x 22



Caspar
35 mm x 37
40 mm x 37
45 mm x 37
50 mm x 37
55 mm x 37
60 mm x 37
65 mm x 37
70 mm x 37



Caspar
35 mm x 52
40 mm x 52
45 mm x 52
50 mm x 52
55 mm x 52
60 mm x 52
65 mm x 52
70 mm x 52

Retractors For Cervical Vertebral Column
Separadores para la columna cervical
Ecarteurs pour colonne vertebrale



Caspar
SS-11-592

mm
40 x 20
45 x 20
50 x 20
55 x 20
60 x 20



Caspar
SS-11-593

mm
50 x 25
60 x 25



Caspar
SS-11-594

mm
40 x 25
45 x 25
50 x 25
55 x 25
60 x 25



Caspar
SS-11-595

mm
40 x 25
45 x 25
50 x 25
55 x 25
60 x 25



Scoville
SS-11-591
only frame
opening 15 cm



Scoville
SS-11-596
mm
50
70



Scoville
SS-11-597
mm
50
70

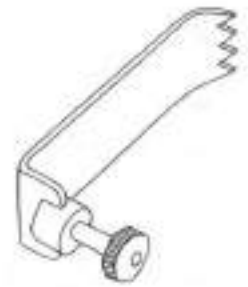

Scoville
SS-11-598
mm
64 x 25
64 x 50
88 x 25



Taylor
SS-11-599
mm
48 x 50
64 x 50
64 x 64
80 x 57



Scoville
SS-11-600
mm
41 x 38
67 x 44



SAPTESTAR

Manufacturer & Exporter Of Surgical, Dental & Veterinary Instruments



+92-340-4040061



exportsaptestar@gmail.com



info@saptestar.com



www.saptestar.com



Defence Road, Near Hotel Javson, 51310-Sialkot Pakistan





SAPTESTAR

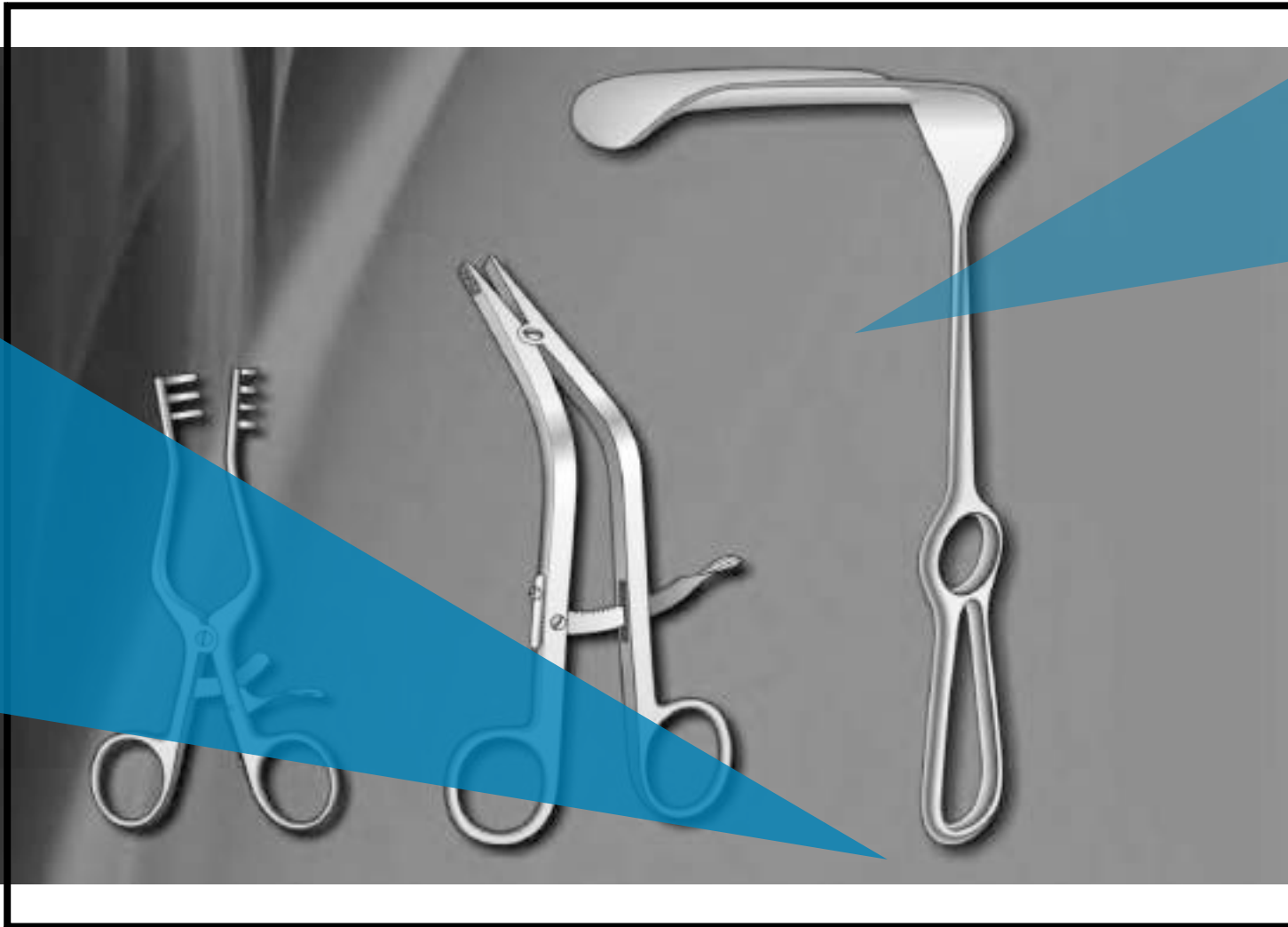

**Manufacturers & Exporters Of Quality Surgical Instruments
Retractors Catalogue**

Group 12 & 13

Retractors 12 & 13



+92-340-4040061



exportsaptestar@gmail.com



info@saptestar.com



www.saptestar.com



Defence Road, Near Hotel Javson, 51310-Sialkot Pakistan

Company Profile



ABOUT US

Quality begins at **SapteStar** Instruments Company where master craftsmen forge and manufacture each instrument to its exact specifications and measurements. Instruments must undergo a series of quality control inspections in order to be worthy of **SapteStar** name and warranty. We offer a wide selection of medical instruments including Surgical and Dental instruments.

We have acquired a unique and unmatched understanding of manufacturing through a large experience, working since 1908. Years of experience & state of the art manufacturing facilities helped us to keep our prices low. Our Surgical & Dental instruments are created by expert craftsmen, providing unfaltering quality you can rely on.

We have launched a fully interactive website where you can get online and track your orders 24 hours a day, 7 days in a week, and 365 days a year. Ask for our free e-catalogue on CD-Rom to save time and enjoy hassle free ordering.

We provide our customers with most reliable customer service as your satisfaction is our top priority. Our customers always enjoy our wonderful customer service and quality tools at the best price.

Lastly we invite you to have a work experience with SapteStar Instruments Company and we will prove ourselves as one of the most valuable source you have.

You can find us at

SapteStar
CEO



Company Profile



History

SAPTESTAR INSTRUMENTS was founded in 1995. Our Great Grandfather **Mian Muhammad Fazal Elahi** was the founder of M/s M.F. Elahi & Company (E.P.) Pvt. Ltd, established in 1908. SapteStar is a sister concern of M.F. Elahi & Co. It is our pride to be a member of M.F. Elahi Family.

SapteStar Instruments Company is located in the heart of beautiful city, Sialkot, Pakistan. We are manufacturers and exporters of quality Surgical, Dental instruments and Scissors of all sorts in various categories. We are closely attached with highly skilled surgeons and other technicians of the surgical industry to make the new instruments development possible.

SapteStar is in a continues process of development and testing of new instruments for their precision and perfect functioning. We are also working at imported forging supply by foreign customers.

Certificates

Instruments Company has achieved the certificates for ISO-9001, ISO-13485, cGMP (FDA) and CE Marking.

Quality Control

All material use in the manufacturing of our instruments are tested from relevant laboratories. Our continuous quality control is our best warranty so that you built confidence in our products.

Deliveries

Deliveries are quick and in-time.

Mode Of Payment

Terms of Payment is ADVANCE or LETTER OF CREDIT (Irrevocable)

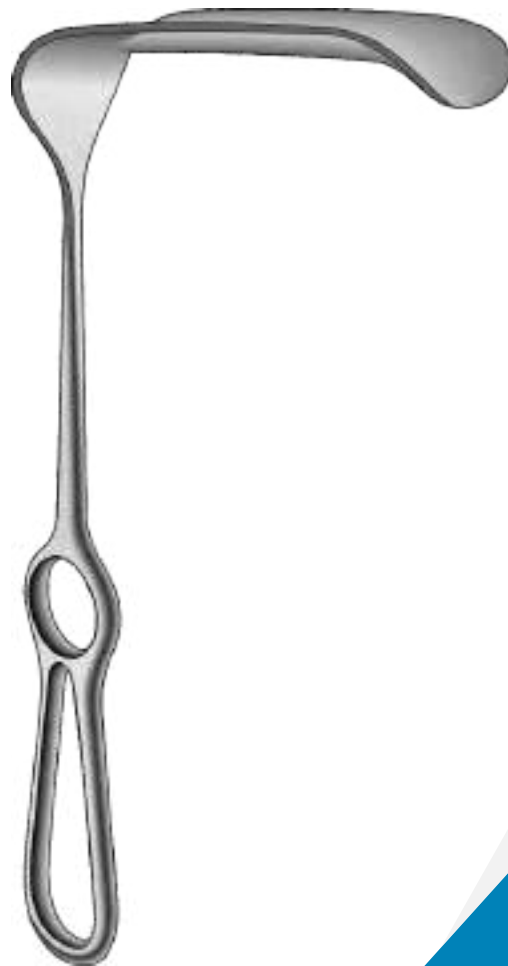

Retractors 12

12 Retractors

Abdominal Intestinal Spatula	50	Marberge (Gil-Vernet)	08
Adson	01	Martin	40
Allison	44	Mathieu	12, 16
Baby-Roux	14	Mayo	34
Brunner	37-38	Meyerdig	11
Casper	01,30	Middeldorpf	28
Collin	13	Mikulicz	39
Collin-Hartmann	15	Mini-Langenbeck	10
Coryllos	43	Moberg	10
Cottle	03,04	Moldestad	03
Cottle-Neivert	07	News Ret.	03
Crile	13	O'connor	03
Cushing	04,08,09	Obwegeser	26
Davidson	44	Ollier	22
Deaver	47-48	Parker	14
Desmarres	09	Parker-Langenbeck	16
Dockhorn	30	Parker-Mott	14
Doyen	33,34	Paul	11
Doyen-Stille	32	Ragnell-Davis	12
Emmet	07	Reverdin	51
Farabeuf	13	Richardson	36
Fomon	07	Richardson-Eastman	35
Ford-Deaver	46	Rollet	04
Foss	46	Rose	13
Frazier	02	Roux	15
Freer	04	Sachs	03,07
Fritsch	35	Sauerbruch	27
Gillies (Converse)	02	Semb	44
Gillies	02	Senn-Green	10
Goelet	15	Senn-Miller	12
Graefee (Tyrell)	02	Simon	07,40
Graham	03	St-marks	41
Green	28	Strandell-Stille	11
Groningen	01	Trachea Ret.	05,06
Guthrie	04	Tuffier	51
Haberer	51	Us-Army	09
Harrington	45	Volkman	17-19
Heaney-Simon	40	Zenker	42
Hibbs	16		
Hosel	31		
Israel	21		
Jackson	12		
Jackson	03		
Joseph	03,05		
Kader	52		
Kelly	36,39		
Kilner	02		
Kirklin	08		
Klapp	11		
Knapp	04		
Kocher	17,20,27,29,49		
Kocher-Langenbeck	24		
Koerte	22		
Krayenbuhl	01		
Lahey	10,05		
Langenbeck	23-25		
Legueu	49		
Luer	13		



SAPTESTAR
Manufacturer & Exporter Of Surgical, Dental & Veterinary Instruments

Nerve & Vessel Hooks
Ganchos para nervios y vasos
Crochets a nerfs et a vaisseaux

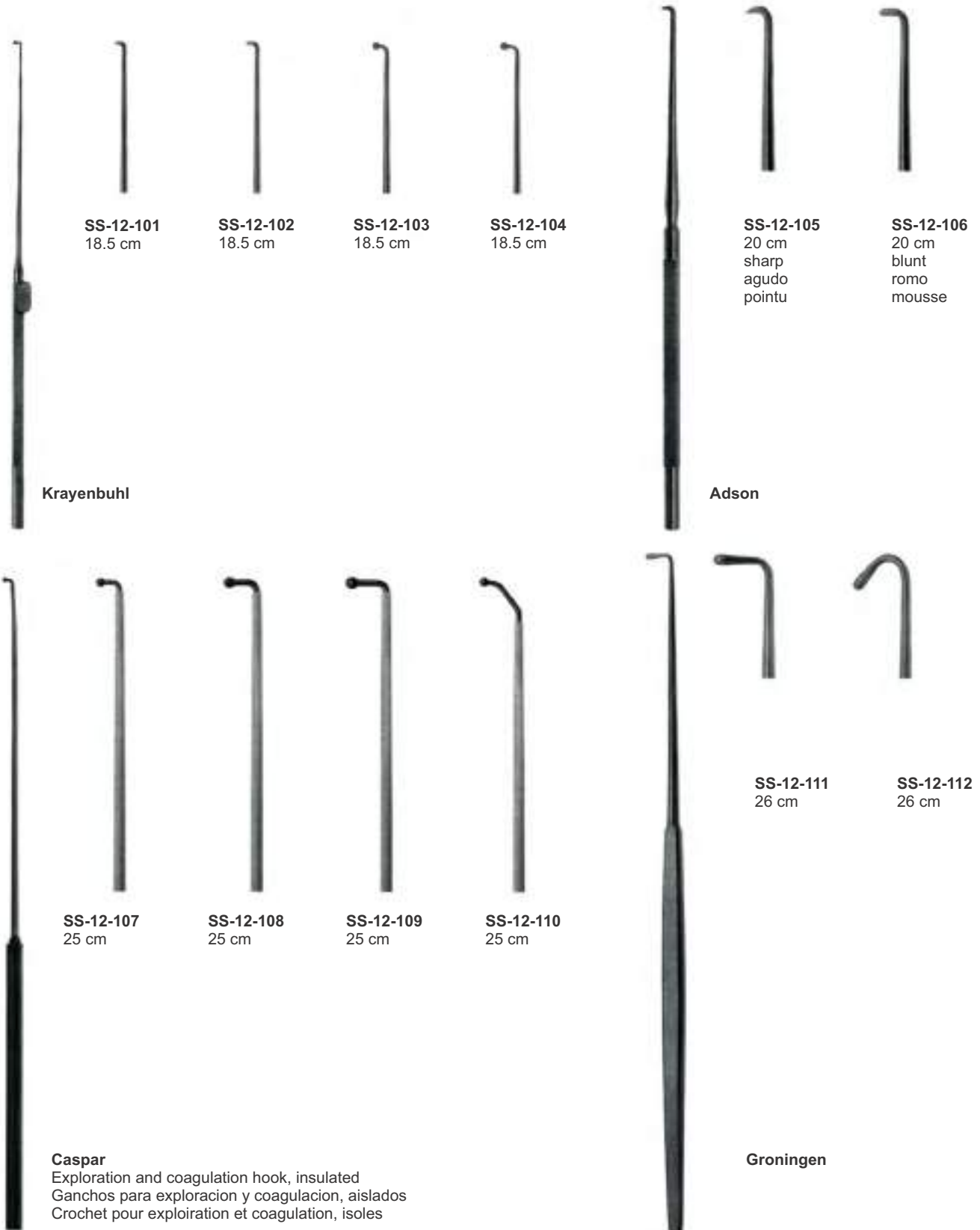

Retractors
Separadores
Ecarteurs



SS-12-113
12 cm
sharp
aguda
pointu

Graefe (Tyrell)

Skin retractors (iris hook)
Ganchos para piel (gancho para iris)
Crochets a peau (Iris)



SS-12-114
12 cm
blunt
romo
mousses



Frazier
SS-12-115
12.5 cm

Dura and skin retractor,sharp
Gancho para piel y dura-madre,agudo
Crochet a peau et a dure-mere, pointu



Kilner
SS-12-116
13 cm

skin retractor,sharp
Gancho para piel ,agudo
Crochet a peau, pointu



Kilner
SS-12-117
15 cm

skin retractor,sharp
Gancho para piel ,agudo
Crochet a peau, pointu



Gillies
SS-12-118
18 cm

skin retractor,sharp
Gancho para piel ,agudo
Crochet a peau, pointu



SS-12-119
18.5 cm

SS-12-120
18.5 cm

Gillies (converse)

Dura and skin retractor,sharp
Gancho para piel y dura-madre,agudo
Crochet a peau et a dure-mere, pointu

Retractors
Separadores
Ecarteurs



Moldestad
SS-12-121
12 cm
vein retractor
Separador para venas
Ecarteur a veines



O'Connor
SS-12-122
12.5 cm
Skin retractor (Iris hook), sharp
Gancho para piel (gancho para iris)
agudo
Crochet a peau (Iris), pointu



Cottle
SS-12-123
16 cm
Dura and skin retractor, sharp
Gancho para piel y dura-madre, agudo
Crochet a peau et a dure-mere, pointu



Joseph
SS-12-124
16 cm
Hook for plastic surgery,
sharp
Gancho para cirugia plastica,
agudo
Crochet pour la chirurgie plastique,
pointu



Graham
SS-12-125
17 cm
Dura hook, blunt
Gancho para dura-madre,
romo
Crochet pour la dure-mere,



Sachs
SS-12-126
18.5 cm
Dura hook, sharp
Gancho para dura-madre,
agudo
Crochet pour la dure-mere,



News
SS-12-127
14.5 cm
Trachea retractor, sharp
Separador para la traquea,
agudo
Ecarteur pour tracheotomie,



Jackson
SS-12-128
14 cm
Trachea retractor, sharp
Separador para la traquea, agudo
Ecarteur pour tracheotomie, pointu

Retractors
Separadores
Ecarteurs



Cushing
SS-12-129
14 cm
Dura hook, sharp
Gancho para dura-madre
agudo
Crochet pour la dure-mere,
pointu



Cottle
SS-12-130
17 cm
Hook for plastic surgery, sharp
Gancho para cirurgia plastica,
agudo
Crochet pour la chirurgie plastique,
pointu



Guthrie
SS-12-131
12.5 cm
Skin retractor (Iris hook), sharp
Gancho para piel (gancho
para iris), agudo
Crochet a plaies (Iris),Pointu



Guthrie
SS-12-132
13 cm
Skin retractor (Iris hook), sharp
Gancho para piel (gancho
para iris), agudo
Crochet a plaies (Iris),Pointu



Rollet
SS-12-133
13.5 cm
sharp
agudo
pointu



Knapp
SS-12-134
13.5 cm
blunt
romo
mousse



Freer
SS-12-135
15 cm
sharp
agudo
pointu



Knapp
SS-12-136
16 cm
sharp
agudo
pointu



SS-12-137
12 cm

SS-12-138
12 cm

SS-12-139
16 cm

SS-12-140
16 cm

SS-12-141
16 cm

SS-12-142
16 cm

Lahey
sharp
agudo
pointu

Joseph
Hook for plastic surgery, sharp
gancho para cirugia plastica, agudas
Crochet pour la chirurgie plastique, pointu



SS-12-143
15 cm

SS-12-144
15 cm

SS-12-147
15 cm

SS-12-148
15 cm

SS-12-145
15 cm

SS-12-146
15 cm

SS-12-149
15 cm

SS-12-150
15 cm

Trachea retractors, sharp / flexible
Separadores para la traquea, agudos / flexibles
Ecarteurs pour tracheotomie, pointu, / flexible

Trachea retractors, blunt / flexible
Separadores para la traquea, romos / flexibles
Ecarteurs pour tracheotomie, mousse, / flexible

Retractors
Separadores
Ecarteurs



SS-12-151
16.5 cm



SS-12-152
16.5 cm



SS-12-153
16.5 cm



SS-12-154
16.5 cm



SS-12-155
16.5 cm



SS-12-157
16.5 cm



SS-12-156
16.5 cm



SS-12-158
16.5 cm

Trachea retractors, sharp
Separadores para la traquea, agudos
Ecarteurs pour tracheotomie, pointu

Trachea retractors, blunt
Separadores para la traquea, romos
Ecarteurs pour tracheotomie, mousse



SS-12-159
17 cm



SS-12-160
17 cm



SS-12-161
17 cm



SS-12-162
17 cm



SS-12-163
17 cm



SS-12-165
17 cm



SS-12-164
17 cm



SS-12-166
17 cm

Trachea retractors, sharp
Separadores para la traquea, agudos
Ecarteurs pour tracheotomie, pointu

Trachea retractors, blunt
Separadores para la traquea, romos
Ecarteurs pour tracheotomie, mousse

Retractors
Separadores
Ecarteurs



Sachs
SS-12-167
21.5 cm
Fistula hook
Gancho para fistulas
Crochet para fistules



Emmet
SS-12-168
22 cm
Fistula hook
Gancho para fistulas
Crochet para fistules



Simon
SS-12-169
22 cm
Fistula hook
Gancho para fistulas
Crochet para fistules



Fomon
SS-12-170
16 cm
Hook for posterior nares
Gancho para las coanas
Crechet nasal



Fomon
SS-12-171
16 cm
Hook for posterior nares
Gancho para las coanas
Crechet nasal



Cottle-Neivert
SS-12-172
20.5 cm
Hook for posterior nares with saw
or knife guide
Gancho para las coanas con guia
para sierra o para cuchillo
Crochet nasal avec scie ou
couteau guides

Retractors
Separadores
Ecarteurs



Cushing
SS-12-173
22.5 cm
Vein retractor
Separador para venas
Ecarteur a veines



Kirklin
13.5 cm
Vein retractor, malleable
Separadores para venas, malleable
Ecarteurs a veines, malleables



SS-12-174
8 x 5 mm (AXB)



SS-12-175
9 x 7 mm (AXB)



SS-12-176
9 x 10 mm (AXB)



SS-12-177
9 x 12 mm (AXB)



SS-12-178
10 x 15 mm (AXB)



SS-12-179
8 x 8 mm (AXB)



SS-12-180
10 x 11 mm (AXB)



SS-12-181
10 x 15 mm (AXB)



SS-12-182
12 x 17 mm (AXB)



SS-12-183
13 x 20 mm (AXB)



SS-12-184
14 x 23 mm (AXB)



Marberger (Gil-Vernet)
24 cm
Vein and hilar retractor, malleable
Separadores para venas y hilares, malleable
Ecarteurs a veines et a hile renal, malleables

Retractors
Separadores
Ecarteurs



SS-12-185
4.5 x 8 mm (AXB)



SS-12-191
4.5 x 8 mm (AXB)



SS-12-197
4.5 x 8 mm (AXB)



SS-12-186
9 x 10 mm (AXB)



SS-12-192
9 x 10 mm (AXB)



SS-12-198
9 x 10 mm (AXB)



SS-12-187
9 x 12 mm (AXB)



SS-12-193
9 x 12 mm (AXB)



SS-12-199
9 x 12 mm (AXB)



SS-12-188
11 x 14 mm (AXB)



SS-12-194
11 x 14 mm (AXB)



SS-12-200
11 x 14 mm (AXB)



SS-12-189
12 x 16 mm (AXB)



SS-12-195
12 x 16 mm (AXB)



SS-12-201
12 x 16 mm (AXB)



SS-12-190
13 x 18 mm (AXB)



SS-12-196
13 x 18 mm (AXB)



SS-12-202
13 x 18 mm (AXB)

Desmarres
14 cm
Vein retractors (lid retractors)
Separadores para venas
(separadores para parpados)
Ecarteurs a veines (releveurs de paupieres)

Cushing
20 cm
Vein retractors
Separadores para venas
Ecarteurs a veines

Cushing
24 cm
Vein retractors
Separadores para venas
Ecarteurs a veines

Retractors
Separadores
Ecarteurs



Senn-Green
16 cm

SS-12-203
10 x 6 mm (AXB)



SS-12-204
20 x 6 mm (AXB)



Mini-Langenbeck
16 cm

SS-12-205
10 x 6 mm (AXB)



SS-12-206
17 x 5 mm (AXB)



SS-12-207
20 x 6 mm (AXB)



SS-12-208
22 x 8 mm (AXB)



Moberg
17.5 cm

SS-12-209
16 x 5 mm (AXB)



SS-12-210
18 x 5 mm (AXB)



SS-12-211
25 x 6 mm (AXB)



Lahey
SS-12-212
20 cm
Goitre retractor



25 x 6 mm (AXB)

Retractors
Separadores
Ecarteurs



Paul
SS-12-213
12.5 cm
Tendon sheath retractor
Separador para vainas tendinosas
Ecarteur a gaines tendineuses



11 x 7 mm (AXB)



Klapp
17.5 cm
Tendon sheath retractor
Separador para vainas tendinosas
Ecarteur a gaines tendineuses



SS-12-214
12 x 6 mm (AXB)



SS-12-215
12 x 11 mm (AXB)



SS-12-216
15 x 11 mm (AXB)



SS-12-217
15 x 6 mm (AXB)



SS-12-218
15 x 6 mm (AXB)



Strandell-Stille
19 cm
Tendon sheath retractor
Separador para vainas tendinosas
Ecarteur a gaines tendineuses



Meyerding
17.5 cm



SS-12-219
18 x 7 mm (AXB)



SS-12-220
16 x 5 mm (AXB)



SS-12-221
7 x 4 mm (AXB)



SS-12-222
10 x 3 mm (AXB)



SS-12-223
7 x 4 mm (AXB)



SS-12-224
7 x 9 mm (AXB)

Retractors
Separadores
Ecarteurs

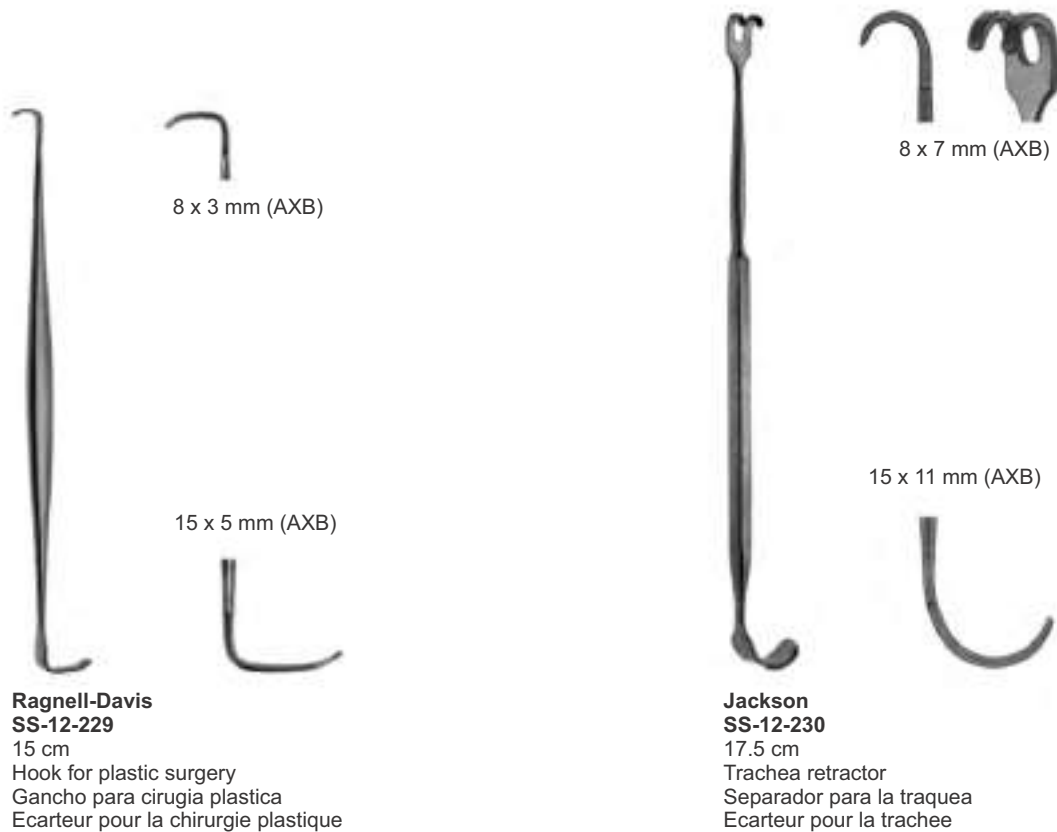
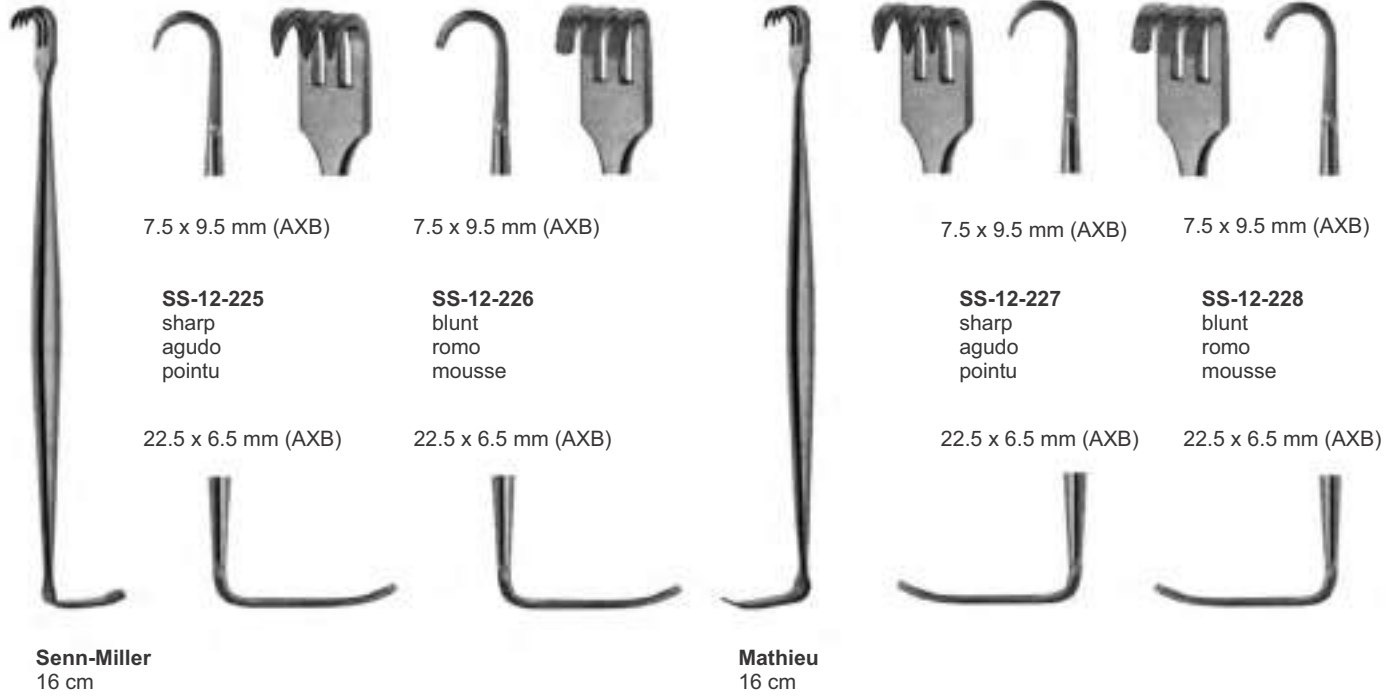

Retractors
Separadores
Ecarteurs

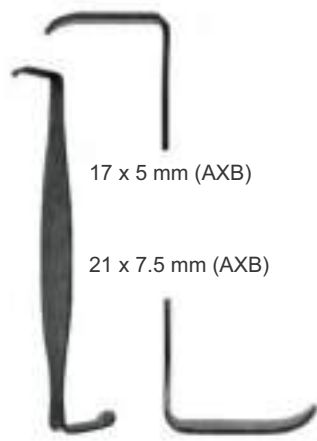

17 x 5 mm (AXB)

21 x 7.5 mm (AXB)

Crile
SS-12-231
10.5 cm

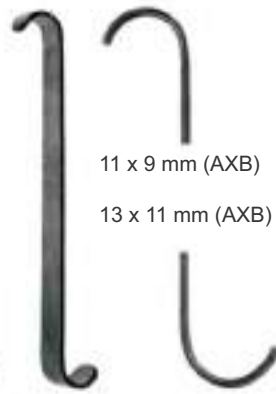

11 x 9 mm (AXB)

13 x 11 mm (AXB)

Luer
SS-12-232
11 cm

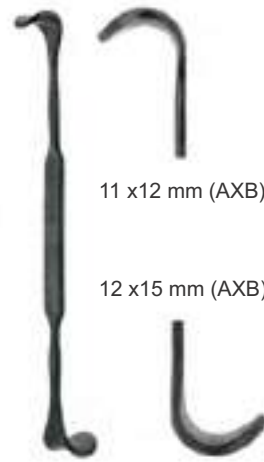

11 x 12 mm (AXB)

12 x 15 mm (AXB)

Rose
SS-12-233
13 cm

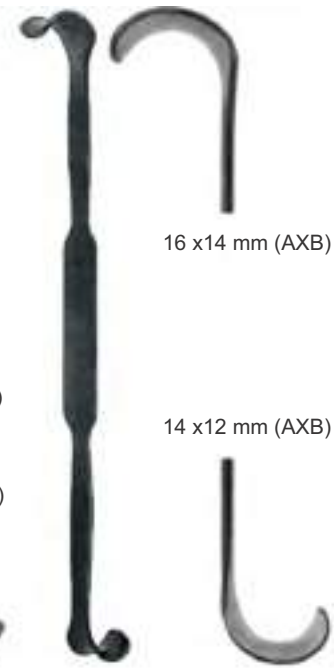

16 x 14 mm (AXB)

14 x 12 mm (AXB)

Rose
SS-12-234
19 cm

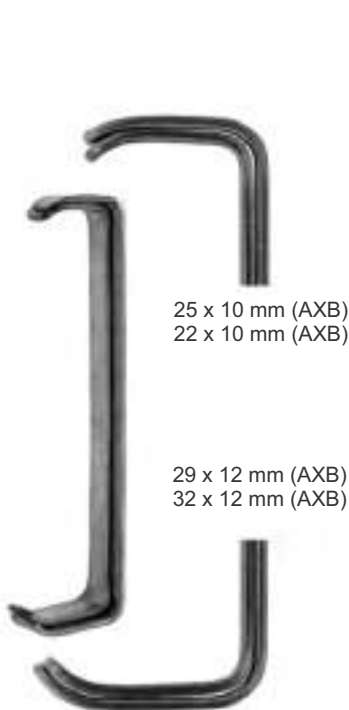

25 x 10 mm (AXB)
22 x 10 mm (AXB)

29 x 12 mm (AXB)
32 x 12 mm (AXB)

Farabeur
SS-12-235
12.5 cm
Set. Juego. jeu

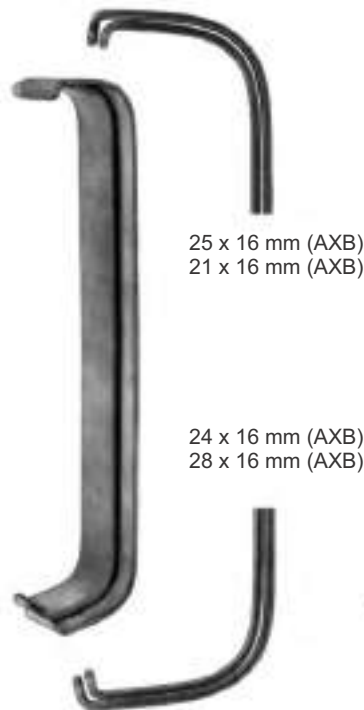

25 x 16 mm (AXB)
21 x 16 mm (AXB)

24 x 16 mm (AXB)
28 x 16 mm (AXB)

Farabeur
SS-12-236
15.5 cm
Set. Juego. jeu

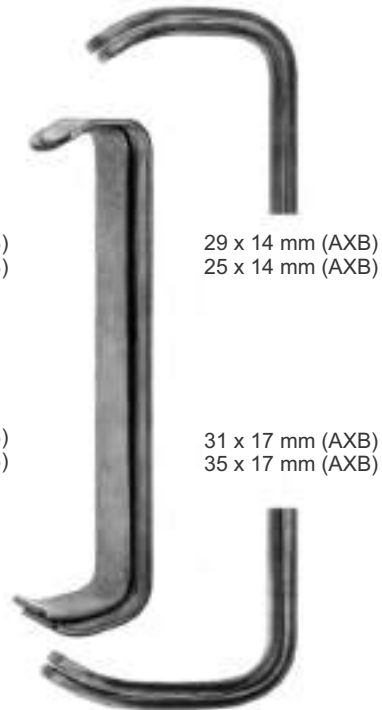

29 x 14 mm (AXB)
25 x 14 mm (AXB)

31 x 17 mm (AXB)
35 x 17 mm (AXB)

Collin
SS-12-237
14.5 cm
Set. Juego. jeu

Retractors
Separadores
Ecarteurs



Parker
SS-12-238
14 cm
set. Juego. jeu



24 x 15 mm (AXB)
21 x 15 mm (AXB)



21 x 15 mm (AXB)
25 x 15 mm (AXB)



Parker
SS-12-239
18 cm
set. Juego. jeu



31 x 25 mm (AXB)
27 x 25 mm (AXB)



26 x 25 mm (AXB)
30 x 25 mm (AXB)



Parker-Mott
SS-12-240
14.5 cm
set. Juego. jeu

63 x 24 mm (AXB)
59 x 24 mm (AXB)

27 x 24 mm (AXB)
33 x 24 mm (AXB)



Baby-Roux
SS-12-241
12.5 cm

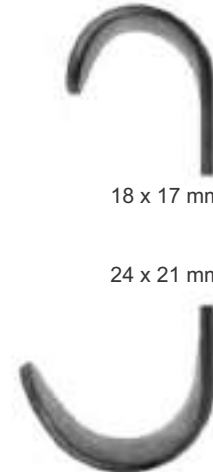

18 x 17 mm (AXB)

24 x 21 mm (AXB)

Retractors
Separadores
Ecarteurs



Roux
17 cm



21 x 24 mm (AXB)

SS-12-242
14.5 cm

29 x 28 mm (AXB)



27 x 26 mm (AXB)

SS-12-243
15.5 cm

32 x 37 mm (AXB)



31 x 30 mm (AXB)

SS-12-244
17 cm

36 x 42 mm (AXB)



Fig. 1



Fig. 2



Fig. 3

Set. Fig. 1-3. Juego. Fig. 1-3 Jeu. Fig. 1-3



35 x 29 mm (AXB)



50 x 35 mm (AXB)

Collin-Hartmann
SS-12-245
15.5 cm



Goelet
SS-12-246
19 cm



35 x 40 mm (AXB)



26 x 31 mm (AXB)

Retractors
Separadores
Ecarteurs



Mathieu
SS-12-247
20.5 cm
set. juego.jeu



50 x 13 mm (AXB)
44 x 13 mm (AXB)



Us-Army (Parker-Langenbeck)
SS-12-248
21 cm
set. Juego. jeu



32 x 15 mm (AXB)
26 x 15 mm (AXB)



40 x 26 mm (AXB)
45 x 26 mm (AXB)



40 x 15 mm (AXB)
44 x 15 mm (AXB)



SS-12-249
27 x 13 mm
(AXB)

SS-12-250
52 x 25 mm
(AXB)

SS-12-251
78 x 27 mm
(AXB)

Hibbs
SS-12-249 24.5 cm
SS-12-250 24.0 cm
SS-12-251 23.5 cm



SS-12-252
75 x 32 mm
(AXB)

SS-12-253
100 x 32 mm
(AXB)

Hibbs
SS-12-252 18.5 cm
SS-12-253 19.0 cm
Spinal retractors
Separadores espinales
Ecarteurs spinal

Retractors
Separadores
Ecarteurs



Kocher
SS-12-254
20 cm



Sharp
agudo
pointu



Kocher



SS-12-255
22 cm
Sharp
agudo
pointu



SS-12-256
22 cm
Blunt
romo
mousse



Volkman



SS-12-257
22 cm
Sharp
agudo
pointu



SS-12-258
22 cm
Blunt
romo
mousse



Volkman



SS-12-259
22 cm
Sharp
agudo
pointu



SS-12-260
22 cm
Blunt
romo
mousse

Retractors
 Separadores
 Ecarteurs



SS-12-261
 10 x 8 mm (AXB)



SS-12-262
 10 x 8 mm (AXB)



SS-12-263
 10 x 13 mm (AXB)



SS-12-264
 10 x 13 mm (AXB)



Volkman
 23 cm



SS-12-265
 10 x 18 mm (AXB)



SS-12-266
 10 x 18 mm (AXB)



SS-12-267
 10 x 28 mm (AXB)
 sharp
 agudo
 pointu



SS-12-268
 10 x 28 mm (AXB)
 blunt
 romo
 mousse

Retractors
Separadores
Ecarteurs



SS-12-269
10 x 8 mm (AXB)



SS-12-270
10 x 8 mm (AXB)



SS-12-271
10 x 8 mm (AXB)



SS-12-272
10 x 13 mm (AXB)



SS-12-273
10 x 13 mm (AXB)



SS-12-274
10 x 13 mm (AXB)



SS-12-275
10 x 18 mm (AXB)



SS-12-276
10 x 18 mm (AXB)



SS-12-277
10 x 18 mm (AXB)



SS-12-278
10 x 28 mm (AXB)



SS-12-279
10 x 28 mm (AXB)



SS-12-280
10 x 28 mm (AXB)



SS-12-281
10 x 40 mm (AXB)
sharp
agujo
pointu



Semi-sharp
semi-agudo
semi-pointu

SS-12-282
10 x 40 mm (AXB)
blunt
romo
mousse



Voklmann
22.5 cm

Retractors
Separadores
Ecarteurs



SS-12-283
15 x 9 mm (AXB)



SS-12-284
15 x 9 mm (AXB)



SS-12-285
15 x 9 mm (AXB)



SS-12-286
15 x 13 mm (AXB)



SS-12-287
15 x 13 mm (AXB)



SS-12-288
15 x 13 mm (AXB)



Kocher
22.5 cm



SS-12-289
15 x 18 mm (AXB)



SS-12-290
15 x 18 mm (AXB)



SS-12-291
15 x 18 mm (AXB)



SS-12-292
15 x 30 mm (AXB)
sharp
agujado
pointu



SS-12-293
15 x 30 mm (AXB)
semi-sharp
semi-agujado
semi-pointu



SS-12-294
15 x 30 mm (AXB)
blunt
romo
mousse



SS-12-295
40 x 40 mm (AXB)



SS-12-296
47 x 50 mm (AXB)



SS-12-297
53 x 60 mm (AXB)



SS-12-298
70 x 70 mm (AXB)



Israel
24.5 cm

Retractors
Separadores
Ecarteurs



SS-12-299
26 x 39 mm (AXB)
sharp
agudo
pointu



SS-12-300
26 x 39 mm
blunt
romo
mousse



25 x 60 mm (AXB)

SS-12-301
25 cm
sharp
agujado
pointu

Koerte
24 cm
handle vertical to the blade
mango vertical a la hoja
manche vertical a la valve



Ollier
SS-12-302
23 cm



Koerte
SS-12-303
24 cm
handle vertical to the blade
mango vertical a la hoja
manche vertical a la valve

38 x 56 mm (AXB)

46 x 55 mm (AXB)

Retractors
Separadores
Ecarteurs

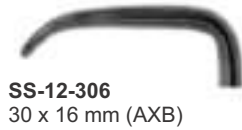

Langenbeck
21.5 cm



Langenbeck
21 cm

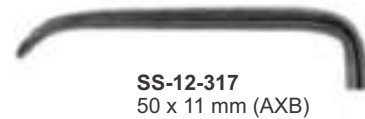
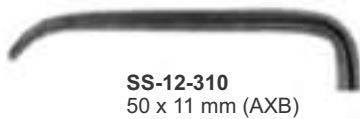
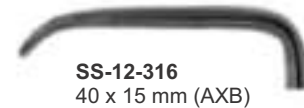
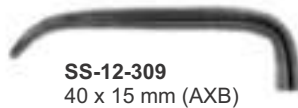
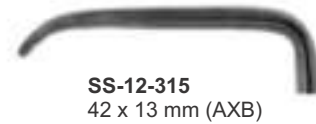
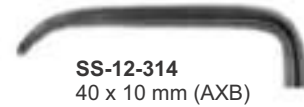

Retractors
Separadores
Ecarteurs



Kocher-Langenbeck
21.5 cm



SS-12-318
25 x 6 mm (AXB)

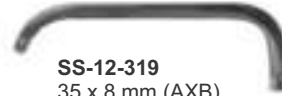

SS-12-319
35 x 8 mm (AXB)



SS-12-320
35 x 11 mm (AXB)

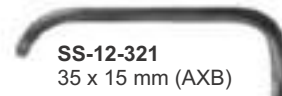

SS-12-321
35 x 15 mm (AXB)



SS-12-322
40 x 11 mm (AXB)

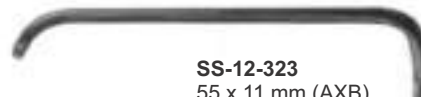

SS-12-323
55 x 11 mm (AXB)



SS-12-324
70 x 14 mm (AXB)



SS-12-325
80 x 12 mm (AXB)



SS-12-326
80 x 16 mm (AXB)



SS-12-327
55 x 20 mm (AXB)



SS-12-328
60 x 20 mm (AXB)



85 x 15 mm (AXB)



Langenbeck
SS-12-327 22.5 cm
SS-12-328 21.5 cm



Langenbeck
SS-12-329
21.5 cm

Retractors
Separadores
Ecarteurs



Soft tissue retractors
Separadores para tejido blando
Ecarteurs pour parties molles

Obwegeser
22 cm



Obwegeser
22 cm

SS-12-330
25 x 7 mm (AXB)

SS-12-331
31 x 10 mm (AXB)

SS-12-332
42 x 11 mm (AXB)

SS-12-333
55 x 12 mm (AXB)

SS-12-334
70 x 14 mm (AXB)

SS-12-335
80 x 16 mm (AXB)

SS-12-336
25 x 7 mm (AXB)

SS-12-337
31 x 10 mm (AXB)

SS-12-338
42 x 11 mm (AXB)

SS-12-339
55 x 12 mm (AXB)

SS-12-340
70 x 14 mm (AXB)

SS-12-341
80 x 16 mm (AXB)

Retractors
Separadores
Ecarteurs



Kocher
23 cm



Sauerbruch
23 cm

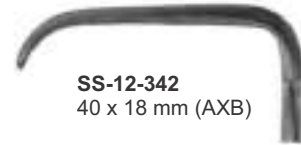

SS-12-342
40 x 18 mm (AXB)



SS-12-343
60 x 20 mm (AXB)



SS-12-344
60 x 25 mm (AXB)

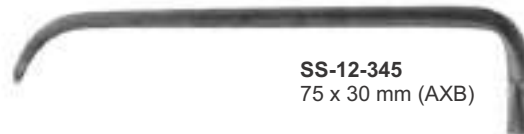

SS-12-345
75 x 30 mm (AXB)

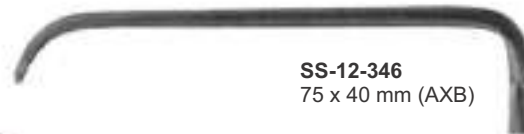

SS-12-346
75 x 40 mm (AXB)



SS-12-347
46 x 16 mm (AXB)



SS-12-348
55 x 22 mm (AXB)

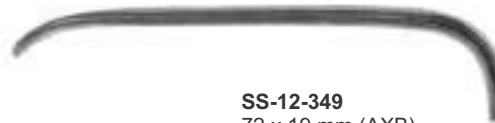

SS-12-349
72 x 19 mm (AXB)

Retractors
Separadores
Ecarteurs



22 x 20 mm (AXB)



Green
SS-12-350
23 cm
Thyroid gland retractors
Separador para la glandula tiroidea
Ecarteur pour la thyroide



SS-12-351
26 x 30 mm (AXB)



Middeldorpf
SS-12-351 21.5 cm
SS-12-352 22.5 cm
SS-12-353 23.5 cm



SS-12-352
20 x 22 mm (AXB)



SS-12-353
15 x 16 mm (AXB)



Middeldorpf
27.5 cm



SS-12-354
55 x 70 mm (AXB)



SS-12-355
45 x 50 mm (AXB)



SS-12-365
45 x 45 mm (AXB)

Retractors
Separadores
Ecarteurs

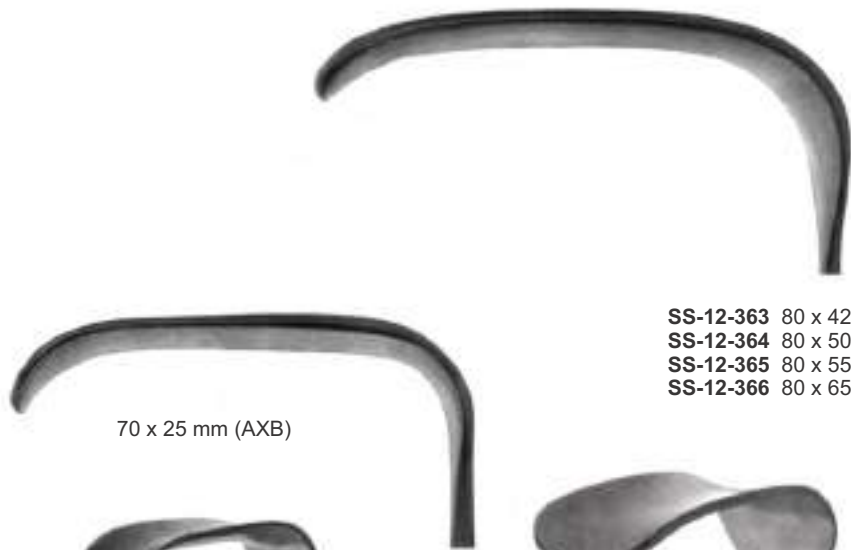

SS-12-363 80 x 42 mm (AXB)
SS-12-364 80 x 50 mm (AXB)
SS-12-365 80 x 55 mm (AXB)
SS-12-366 80 x 65 mm (AXB)



Kocher
22.5 cm



Kocher
SS-12-362
23 cm



Kocher
24.5 cm

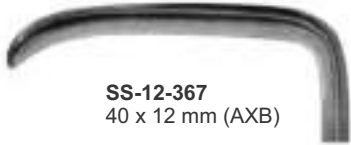

SS-12-367
40 x 12 mm (AXB)

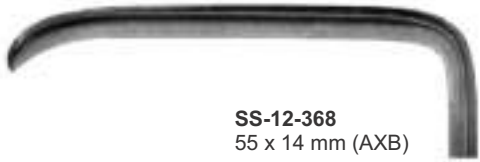

SS-12-368
55 x 14 mm (AXB)

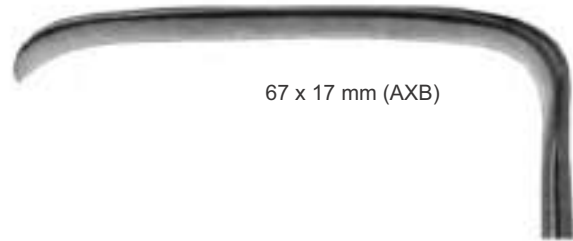

67 x 17 mm (AXB)



Dockhorn
21 cm



Caspar
SS-12-369
22.5 cm



SS-12-370
60 x 20 mm (AXB)

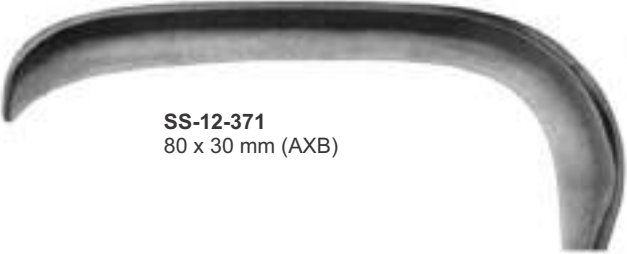

SS-12-371
80 x 30 mm (AXB)



SS-12-372
100 x 30 mm (AXB)



SS-12-373
120 x 30 mm (AXB)

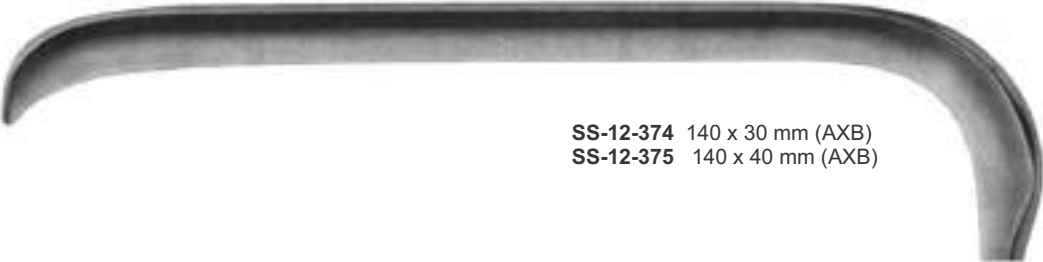

SS-12-374 140 x 30 mm (AXB)
SS-12-375 140 x 40 mm (AXB)



Hosel
25 cm / 10"

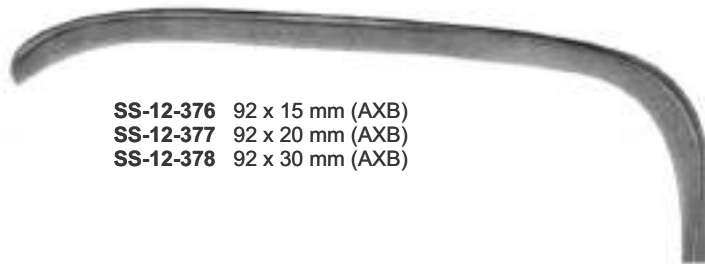

SS-12-376 92 x 15 mm (AXB)
SS-12-377 92 x 20 mm (AXB)
SS-12-378 92 x 30 mm (AXB)

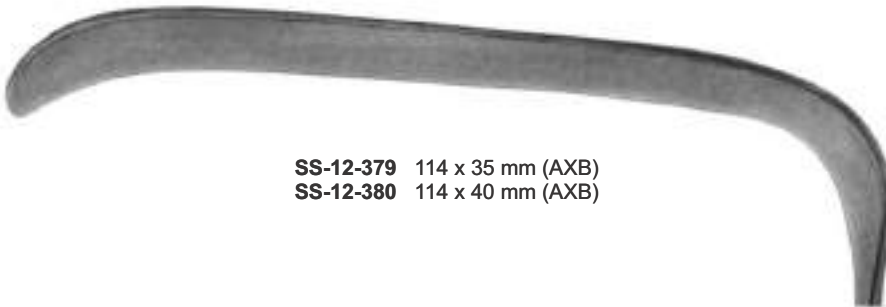

SS-12-379 114 x 35 mm (AXB)
SS-12-380 114 x 40 mm (AXB)



SS-12-381 120 x 55 mm (AXB)



Doyen-Stille
24 cm
handle vertical to the blade
mango vertical a la hoja
manche vertical a la valve

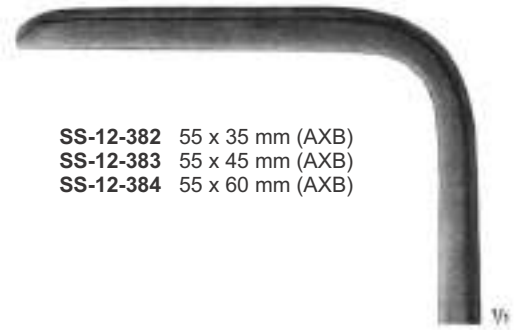

SS-12-382 55 x 35 mm (AXB)
SS-12-383 55 x 45 mm (AXB)
SS-12-384 55 x 60 mm (AXB)

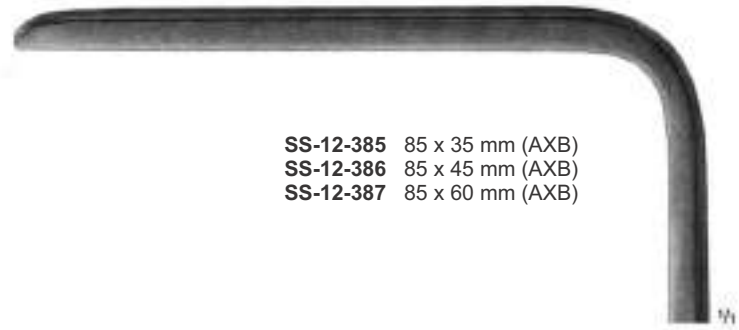

SS-12-385 85 x 35 mm (AXB)
SS-12-386 85 x 45 mm (AXB)
SS-12-387 85 x 60 mm (AXB)



Doyen
23 cm
Abdominal retractors
Separadores abdominales
Ecarteurs intra abdominaux

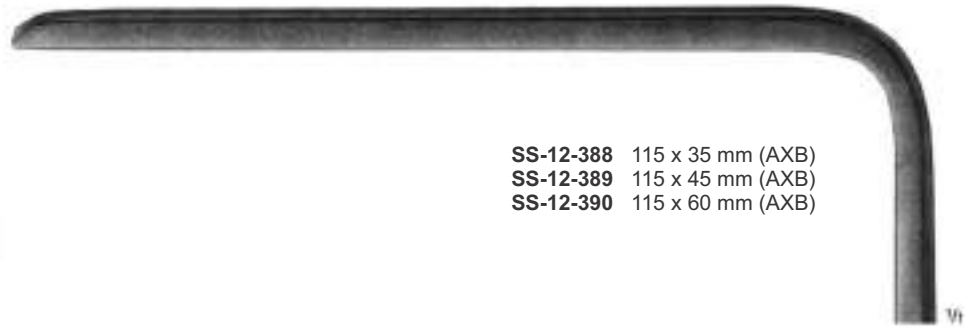

SS-12-388 115 x 35 mm (AXB)
SS-12-389 115 x 45 mm (AXB)
SS-12-390 115 x 60 mm (AXB)



SS-12-391 160 x 45 mm (AXB)
SS-12-391-A 160 x 60 mm (AXB)

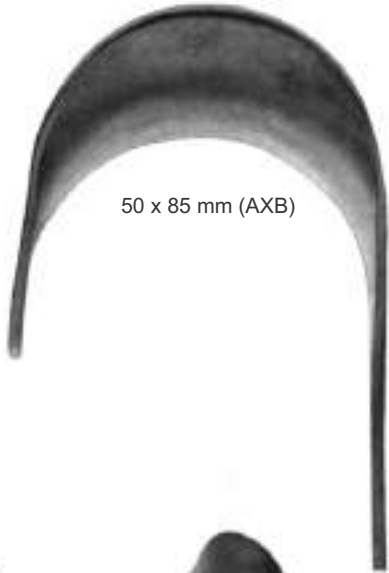

50 x 85 mm (AXB)



Doyen
SS-12-392
24 cm
Abdominal retractor
Separador abdominal
Ecarteur intra abdominaux

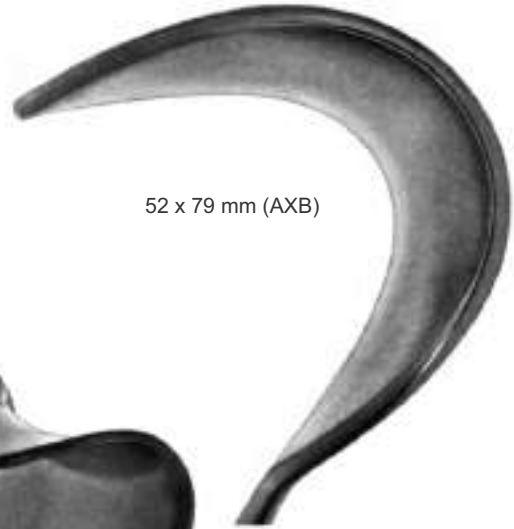

52 x 79 mm (AXB)



Mayo
SS-12-393
27.5 cm
Abdominal retractor
Separador abdominal
Ecarteur intra abdominaux



60 x 85 mm (AXB)



25 x 22 mm (AXB)

43 x 39 mm (AXB)



45 x 75 mm (AXB)

SS-12-399
25.5 cm

SS-12-400
27 cm



34 x 30 mm (AXB)

65 x 43 mm (AXB)



40 x 50 mm (AXB)
40 x 60 mm (AXB)



Fritsch

- SS-12-394** 23.5 cm
- SS-12-395** 24.5 cm
- SS-12-396** 24.5 cm
- SS-12-397** 25.0 cm
- SS-12-398** 26.0 cm

handle vertical to the blade
mango vertical a la hoja
manche vertical a la valve



35 x 40 mm (AXB)

Richardson-Eastman
27 cm
Set. Juego. jue



SS-12-401
 50 x 19 mm (AXB)



SS-12-402
 43 x 39 mm (AXB)



74 x 65 mm (AXB)



Richardson
 24 cm



SS-12-403
 32 x 30 mm (AXB)



SS-12-404
 25 x 21 mm (AXB)



Kelly
SS-12-405 23.5 cm / 9 1/4"
SS-12-406 24.0 cm / 9 1/2"
SS-12-407 25.0 cm / 10"

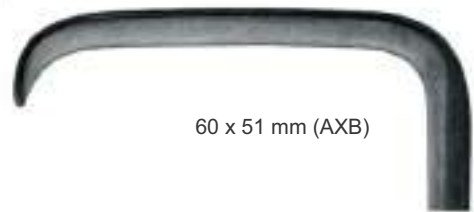

60 x 51 mm (AXB)



50 x 41 mm (AXB)



SS-12-408 180 x 30 mm (AXB)

SS-12-409 160 x 30 mm (AXB)

SS-12-410 140 x 30 mm (AXB)

SS-12-411 130 x 30 mm (AXB)

SS-12-412 120 x 25 mm (AXB)

SS-12-413 100 x 25 mm (AXB)

SS-12-414 80 x 20 mm (AXB)

Brunner
25 cm



SS-12-415 180 x 30 mm (AXB)

SS-12-416 160 x 30 mm (AXB)

SS-12-417 140 x 25 mm (AXB)

SS-12-418 120 x 25 mm (AXB)

SS-12-419 100 x 20 mm (AXB)

SS-12-420 80 x 20 mm (AXB)

Brunner
25 cm



Retractors
Separadores
Ecarteurs



63 x 45 mm (AXB)

182 x 59 mm (AXB)

72 x 45 mm (AXB)

185 x 59 mm (AXB)

35 x 45 mm (AXB)

135 x 59 mm (AXB)

St.Marks
SS-12-433
32.5 cm
Pelvis retractor
Separador para pelvis
Ecarteur a pelvis

St.Marks
SS-12-432
31 cm
Pelvis retractor
Separador para pelvis
Ecarteur a pelvis

St.Marks
SS-12-431
29 cm
Pelvis retractor
Separador para pelvis
Ecarteur a pelvis

Retractors
 Separadores
 Ecarteurs

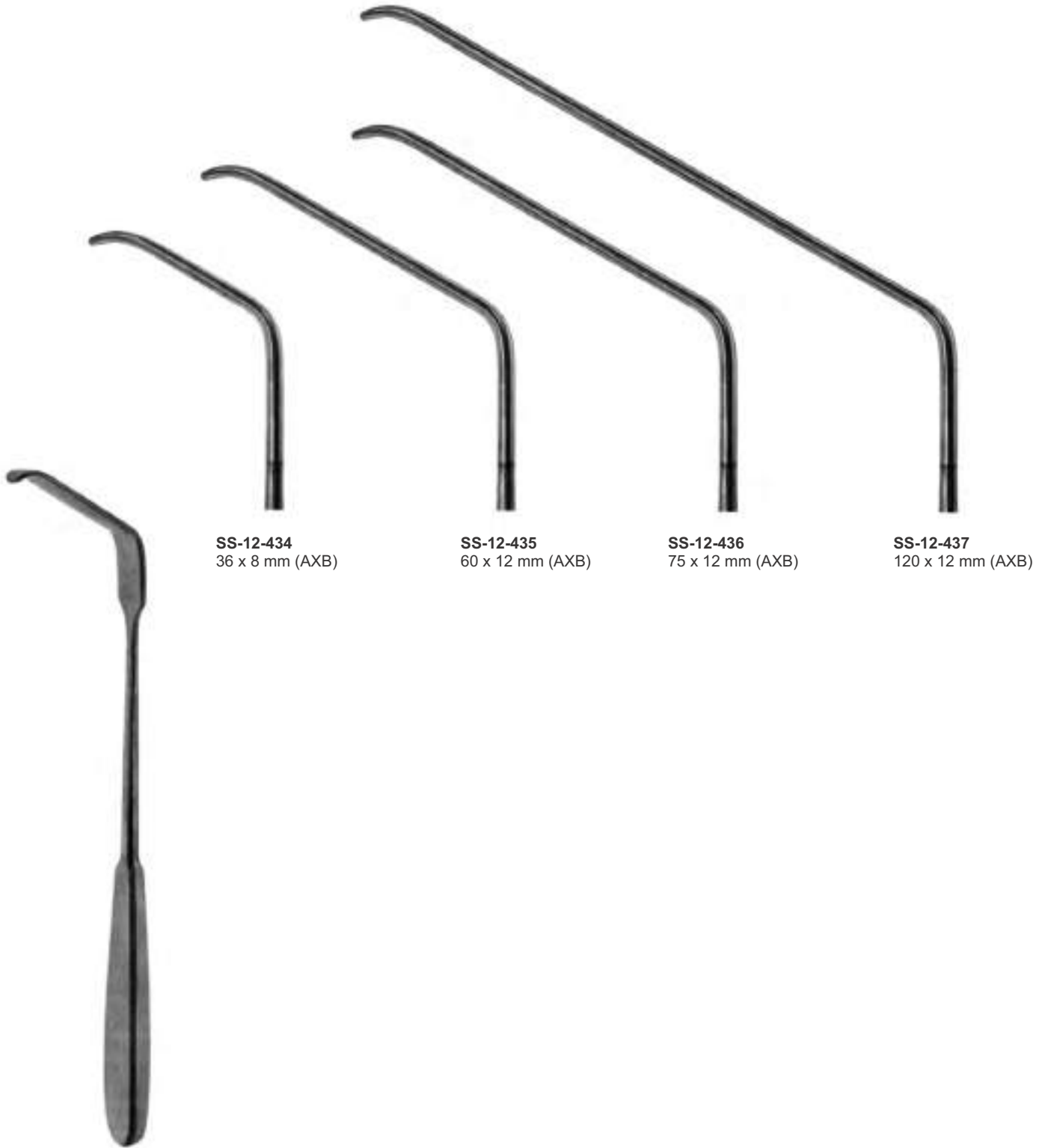

SS-12-434
 36 x 8 mm (AXB)

SS-12-435
 60 x 12 mm (AXB)

SS-12-436
 75 x 12 mm (AXB)

SS-12-437
 120 x 12 mm (AXB)

Zenker
SS-12-434 24.0 cm
SS-12-435 25.0 cm
SS-12-436 26.5 cm
SS-12-437 30.0 cm

Retractors
Separadores
Ecarteurs

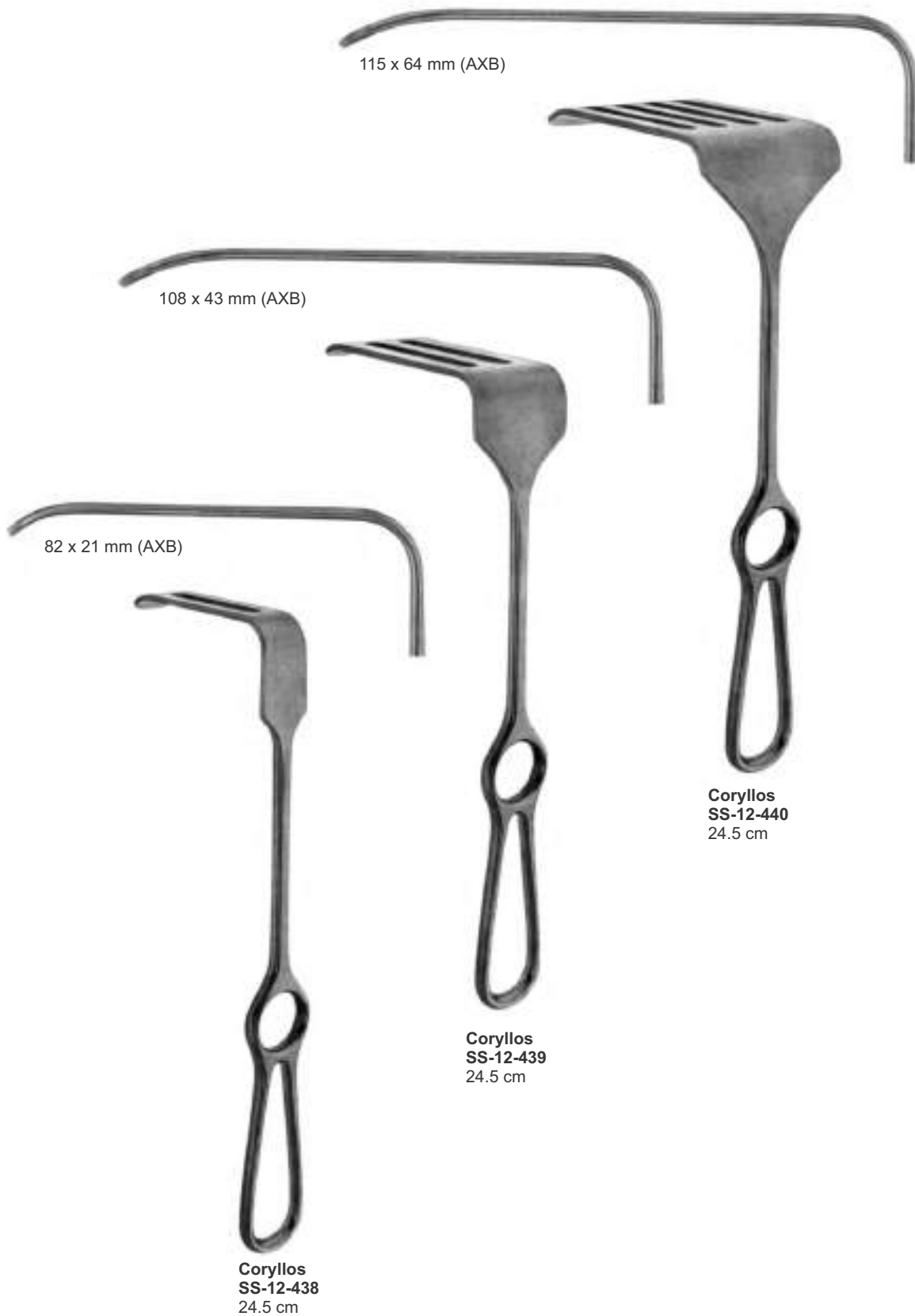

Retractors
Separadores
Ecarteurs



Davidson
SS-12-441
22 cm
Scapula retractor
Separador para scapula
Ecarteur a scapula



Davidson
SS-12-442
22 cm
Scapula retractor
Separador para scapula
Ecarteur a scapula



SS-12-443
18 mm



SS-12-444
24 mm



Semb
27.5 cm
Lung retractors
Separadores para el pulmon
Ecarteurs a poumons



Allison
SS-12-445
32.5 cm
Lung spatula
Separadores para el pulmon
Ecarteurs a poumons

Retractors
Separadores
Ecarteurs

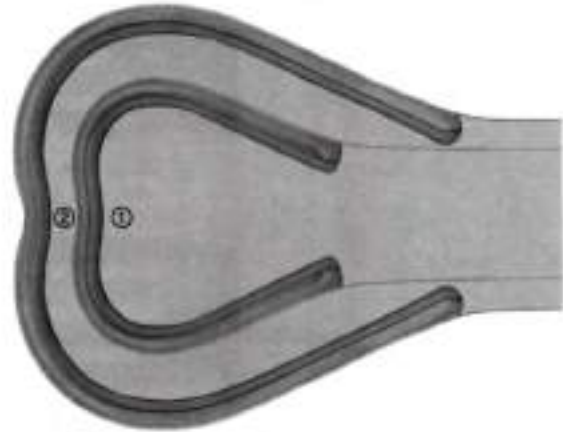
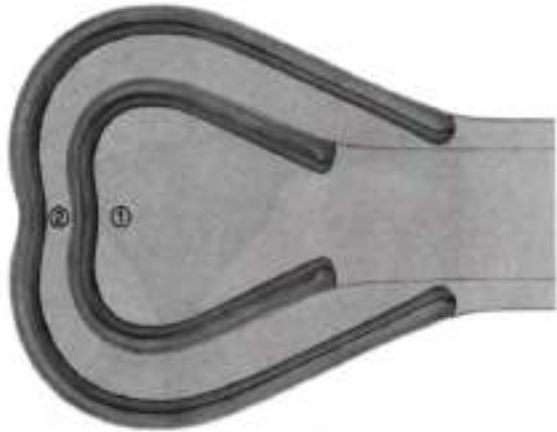

SS-12-446
150 x 41 mm (AXB)

SS-12-447
150 x 62 mm (AXB)

Harrington
32 cm / 12 1/2"



SS-12-448
150 x 41 mm (AXB)

SS-12-449
150 x 62 mm (AXB)

Harrington
33.5 cm



165 x 50 mm (AXB)



Foss
SS-12-450
36.5 cm



160 x 50 mm (AXB)

Ford-Deaver
SS-12-451
42 cm

Retractors
Separadores
Ecarteurs



111 x 25 mm (AXB)

Deaver
SS-12-452
23 cm



40 x 19 mm (AXB)

Deaver
SS-12-453
18 cm



55 x 22 mm (AXB)

Deaver
SS-12-454
22 cm



55 x 25 mm (AXB)

Deaver
SS-12-455
23 cm



100 x 25 mm (AXB)

Deaver
SS-12-456



100 x 25 mm (AXB)

Deaver
SS-12-457



100 x 25 mm (AXB)

Deaver
SS-12-458

Retractors
 Separadores
 Ecarteurs

100 x 38 mm (AXB)



Deaver
SS-12-459
 30 cm

100 x 50 mm (AXB)



Deaver
SS-12-460
 30 cm

100 x 75 mm (AXB)



Deaver
SS-12-461
 30.5 cm

100 x 25 mm (AXB)



Deaver
SS-12-462
 30 cm

100 x 38 mm (AXB)



Deaver
SS-12-463
 30 cm

100 x 50 mm (AXB)



Deaver
SS-12-464
 30 cm

100 x 75 mm (AXB)



Deaver
SS-12-465
 30 cm

Bladder Spatulas
Espatulas para la vesicula
Spatules vesicales



105 x 35 mm (AXB)

Legueu
SS-12-466
27 cm



105 x 67 mm (AXB)

Kocher
SS-12-467
25 cm

Abdominal & Intestinal Spatulas
 Espatulas abdominales e intestinales
 Spatules abdominaux et intestinaux



SS-12-468
 170 x 16 mm
 malleable
 maleable
 malleable



SS-12-469
 190 x 25 mm
 malleable
 maleable
 malleable



SS-12-470 200 x 13 mm
SS-12-471 200 x 16 mm
 malleable
 maleable
 malleable



SS-12-472 330 x 20 mm
SS-12-473 330 x 25 mm
SS-12-474 330 x 30 mm
SS-12-475 330 x 35 mm
SS-12-476 330 x 40 mm
SS-12-477 330 x 45 mm
SS-12-478 330 x 50 mm
 malleable
 maleable
 malleable

Abdominal & intestinal Spatulas
Espatulas abdominales e intestinales
Spatules abdominaux et intestinaux



Tuffier
SS-12-479
200 x 17/24 mm
malleable
maleable
malleable



Haberer
SS-12-480
300 x 40/50 mm
malleable
maleable
malleable



Reverdin
SS-12-481
280 x 41/65 mm

Abdominal & intestinal Spatulas
Espatulas abdominales e intestinales
Spatules abdominaux et intestinaux

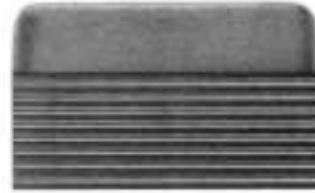

SS-12-482
40 mm

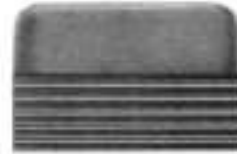

SS-12-483
30 mm



SS-12-484
20 mm



Kader
26.5 cm



SAPTESTAR
Manufacturer & Exporter Of Surgical, Dental & Veterinary Instruments

Self-Retaining Retractors Separadores autostaticos Ecarteurs autostiques

Lacrimal Sac Retractors
Separadores para saco lacrimal
Ecarteurs pour le sac lacrymal



SS-13-101
7 cm



SS-13-102
4 cm



SS-13-103
7 cm



SS-13-104
3 cm

4 x 4 teeth
4 x 4 dientes
4 x 4 dents



Alm



SS-13-105
7 cm
sharp
agudo
pointu



4 x 4



SS-13-106
10 cm
sharp
agudo
pointu



4 x 4



SS-13-107
7 cm
blunt
romo
mousse



4 x 4



SS-13-108
7 cm
blunt
romo
mousse



4 x 4



SS-13-109
sharp
agudo
pointu



SS-13-110
blunt
romo
mousse



Kaupp
(Holzheimer/Heiss)
10 cm

Self-Retaining Retractors
Separadores autostaticos
Ecarteurs autostiques



Jansen Gifford
SS-13-111
sharp
SS-13-112
blunt



Medicon
SS-13-113
11 cm



SS-13-115
center blade only

Shambaugh
SS-13-114
11 cm



William



Williams
SS-13-116
1 cm / 5 cm



Williams
SS-13-117
1 cm / 7 cm

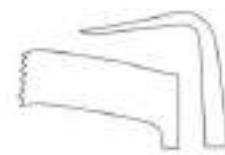

Williams
SS-13-118
2 cm / 5 cm



Williams
SS-13-119
2 cm / 7 cm

Wound Spreaders, Self-Retaining
 Separadores autostaticos
 Ecarteurs autostiques

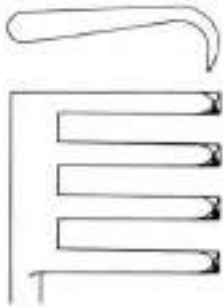

SS-13-120
 26 cm
 sharp
 agudo
 pointu

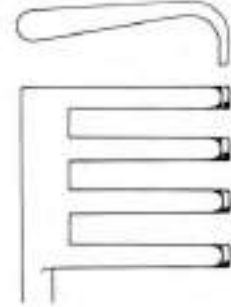

SS-13-121
 26 cm
 blunt
 romo
 mousse



Adson

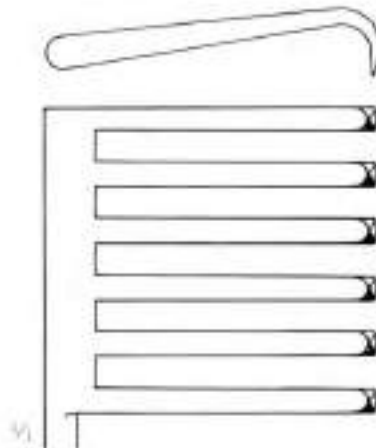

SS-13-120
 29 cm
 sharp
 agudo
 pointu

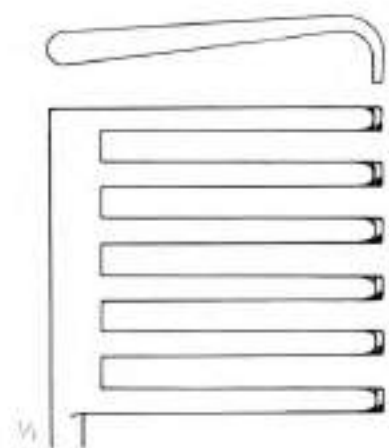

SS-13-123
 29 cm
 blunt
 romo
 mousse



Wound Spreaders, Self-Retaining
Separadores autostaticos
Ecarteurs autostiques



SS-13-124
10 cm
blunt
romo
mousse

Jansen

With adjusting screw
con tornillo de ajuste
avec vis d'ajustage

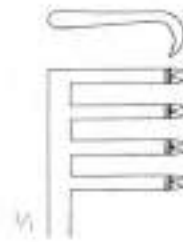

3:4
SS-13-125
13.5 cm
sharp
agudo
pointu

Scalp-Contour

With ratchet
con cremallera
avec cremaillere

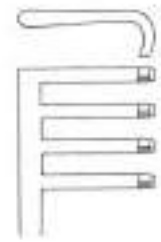

3:4
SS-13-126
13.5 cm
blunt
romo
mousse

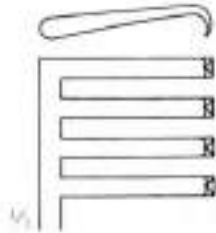

4:4
sharp
agudo
pointu

Anderson-Adson
SS-13-127
20 cm

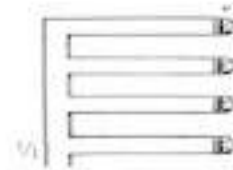

SS-13-128
3:4
sharp
agudo
pointu

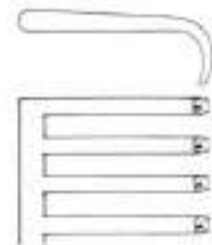

SS-13-129
3:4
blunt
romo
mousse

Weitlaner
20 cm

Wound Spreaders, Self-Retaining
 Separadores autostaticos
 Ecarteurs autostiques



Weitlaner



SS-13-130
 11 cm

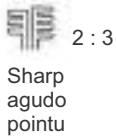

SS-13-131
 11 cm

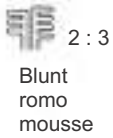

Weitlaner

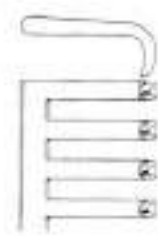

SS-13-132
 13.5 cm
 sharp
 agudo
 pointu



SS-13-133
 16 cm
 sharp
 agudo
 pointu



SS-13-134
 13.5 cm
 blunt
 romo
 mousse



SS-13-135
 16 cm
 blunt
 romo
 mousse



Weitlaner-Wullstein



SS-13-136
 13 cm
 sharp
 agudo
 pointu

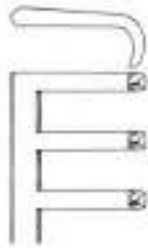

SS-13-137
 13 cm
 blunt
 romo
 mousse



Mollison



SS-13-138
 15.5 cm
 sharp
 agudo
 pointu



Wound Spreaders, Self-Retaining
Separadores autostaticos
Ecarteurs autostiques

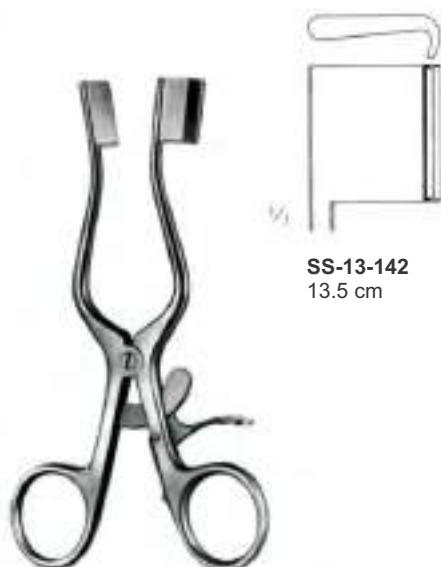
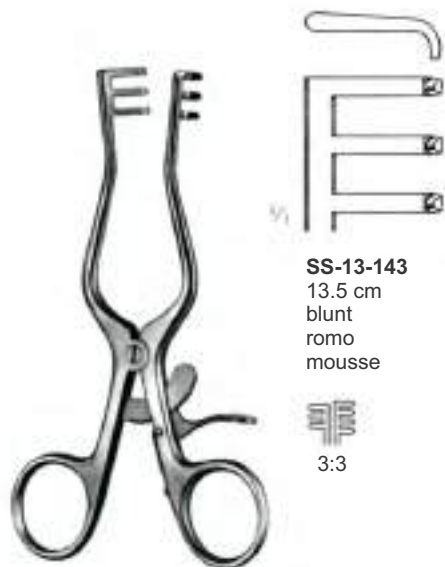

Wound Spreaders, Self-Retaining
 Separadores autostaticos
 Ecarteurs autostiques

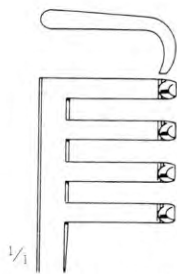

1/4

SS-13-145
 16 cm
 blunt
 romo
 mousse

3:4

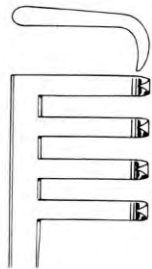

SS-13-146
 16 cm
 sharp
 agudo
 pointu

3:4

Central blades
 Valvas centrales
 Valvas centrales



Henley
 16 cm



SS-13-147



SS-13-148



SS-13-149

Wound Spreaders, Self-Retaining
Separadores autostaticos
Ecarteurs autostiques

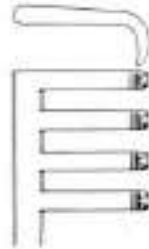

SS-13-150
13.5 cm

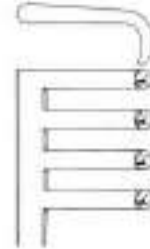

SS-13-151
13.5 cm



SS-13-152
16.5 cm



SS-13-153
16.5 cm



SS-13-154
21 cm



SS-13-155
21 cm



SS-13-156
24.5 cm
Sharp
agudo
pointu



SS-13-157
24.5 cm
Blunt
romo
mousse



Adson



3 : 4

Wound Spreaders, Self-Retaining
Separadores autostaticos
Ecarteurs autostiques



Cloward



SS-13-158
40 cm



SS-13-159
45 mm



SS-13-160
50 mm



SS-13-161
55 mm



SS-13-162
60 mm

SS-13-163
25 cm
Spreader only
Separador suelto
Ecarteur seul

SS-13-164
25 cm
Complete
completo
complet

With 2 each plug-in blades ref.
Con 2 valvas enchufables de c.u.ref.
Chacun avec deux valves
interchangeables ref.

Wound Spreaders, Self-Retaining
 Separadores autostaticos
 Ecarteurs autostiques



SS-13-165
 40 cm



SS-13-166
 45 mm



SS-13-167
 50 mm



SS-13-168
 55 mm



SS-13-169
 60 mm

SS-13-170
 15 cm
 Spreader only
 Separador suelto
 Ecarteur seul

SS-13-171
 15 cm
 Complete
 completo
 complet



Cloward

With 2 each plug-in blades ref.
 Con 2 valvas enchufables de c.u.ref.
 Chacun avec deux valves
 interchangeables ref.

Wound Spreaders, Self-Retaining
 Separadores autostaticos
 Ecarteurs autostiques



Beckman-Adson

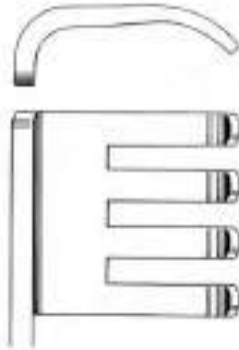

SS-13-172
 30.5 cm



Blunt
 romo
 mousse

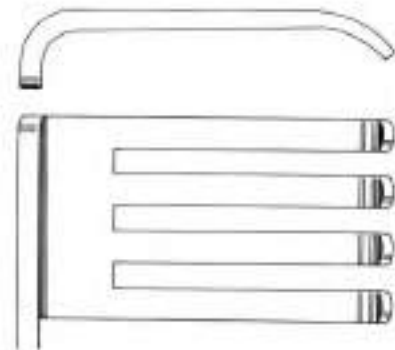

SS-13-173
 30.5 cm



Blunt
 romo
 mousse

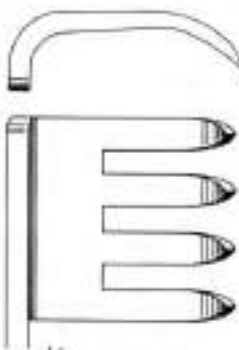

SS-13-174
 30.5 cm



sharp
 agudo
 pointu

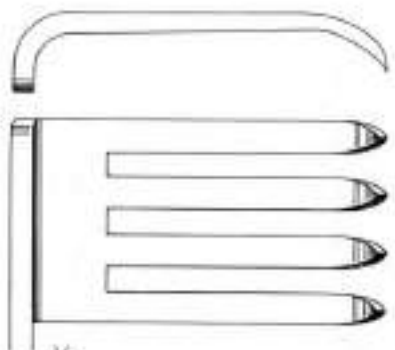

SS-13-175
 30.5 cm



sharp
 agudo
 pointu

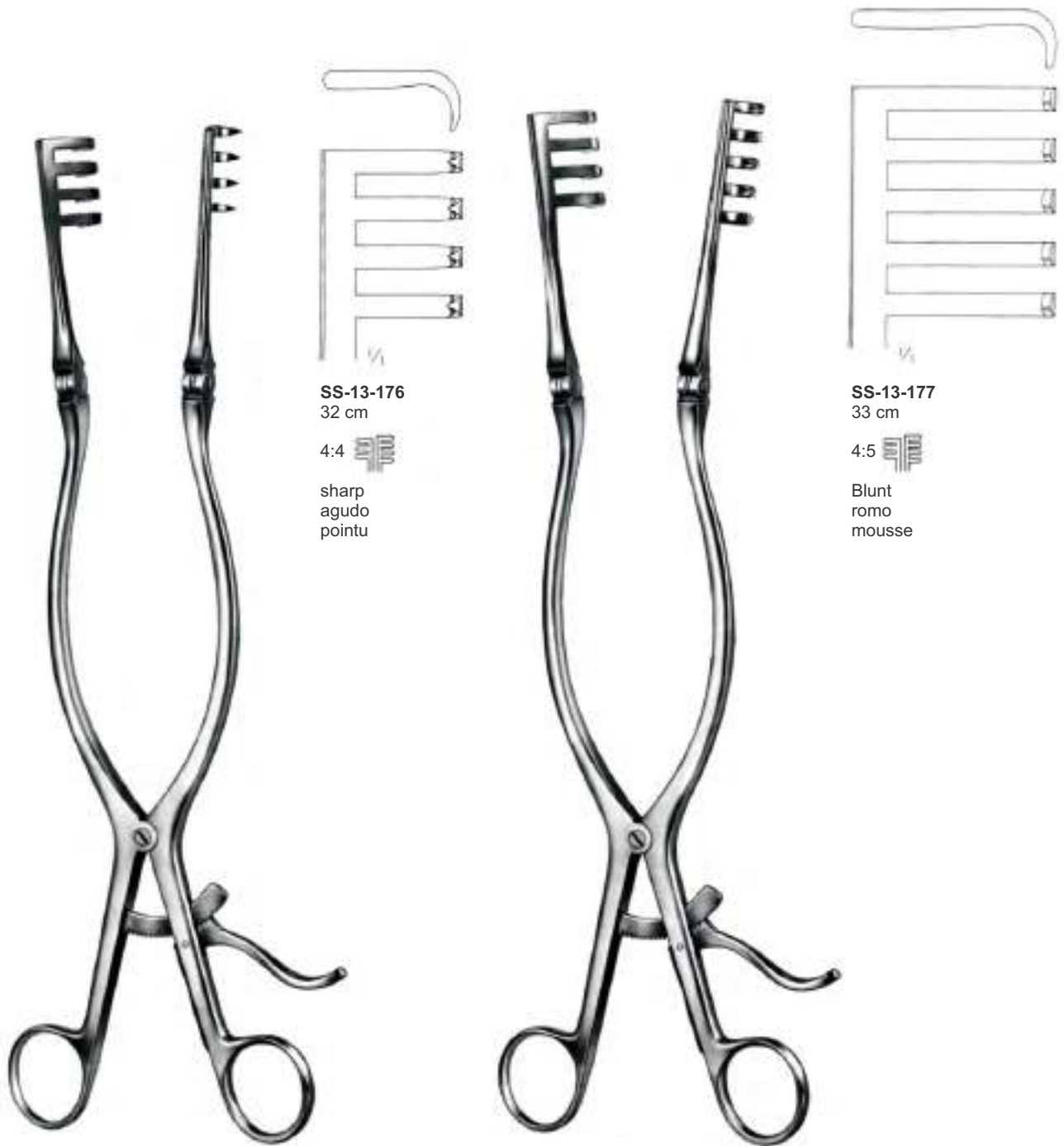

SS-13-176
32 cm

4:4 

sharp
agudo
pointu

SS-13-177
33 cm

4:5 

Blunt
romo
mousse

Beckman

Adson

Wound Spreaders, Self-Retaining
Separadores autostaticos
Ecarteurs autostiques

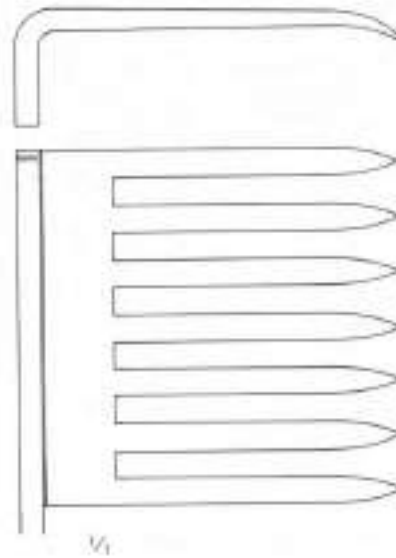

SS-13-178
32 cm

7:7 

sharp
agudo
pointu

Beckman-Eaton

Wound Spreaders, Self-Retaining
Separadores autostaticos
Ecarteurs autostiques



Martin

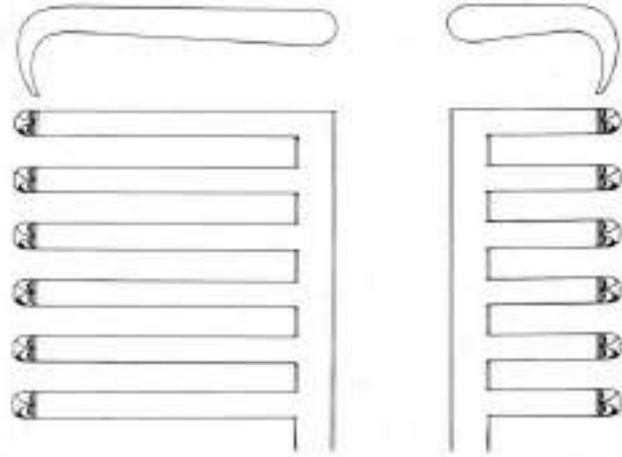

SS-13-179
28.5 cm

6:6 

sharp, long teeth on left side
agudo, garfios largos a la izquierda
pointu, griffes longues a gauche

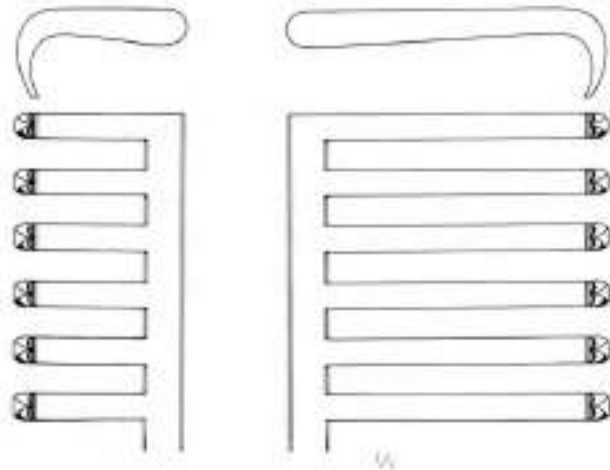

SS-13-180
28.5 cm

6:6 

sharp, long teeth on right side
agudo, dientes largos a la derecha
pointu, griffes longues a droite

Wound Spreaders, Self-Retaining
 Separadores autostaticos
 Ecarteurs autostiques



SS-13-383
 29 x 80 mm
 Lateral blades only (Pair)

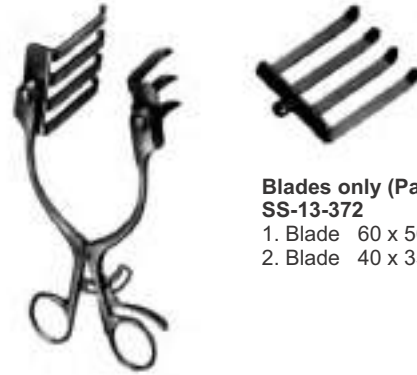

Blades only (Pair)
SS-13-372
 1. Blade 60 x 50 mm
 2. Blade 40 x 35 mm

- Holzbach**
SS-13-380 Complete set
SS-13-381 Spreader only
SS-13-382 Center Blades 74 x 82 mm
SS-13-383 Lateral blades 59 x 80 mm

- Poplitea**
SS-13-370 Retractor complete set
SS-13-371 Retractor only
SS-13-372 Blades (Pair)



sharp agudo pointu



blunt romo mousse



Jansen
SS-13-190
 10 cm / 4"



Jansen
SS-13-191
 10 cm / 4"



Joll
SS-13-192
15.5 cm
Thyroid and vaginal retractor
Separador para tiroides y vagina
Ecarteur pour thyroide et vulva



SS-13-193
13 cm

Gelpi

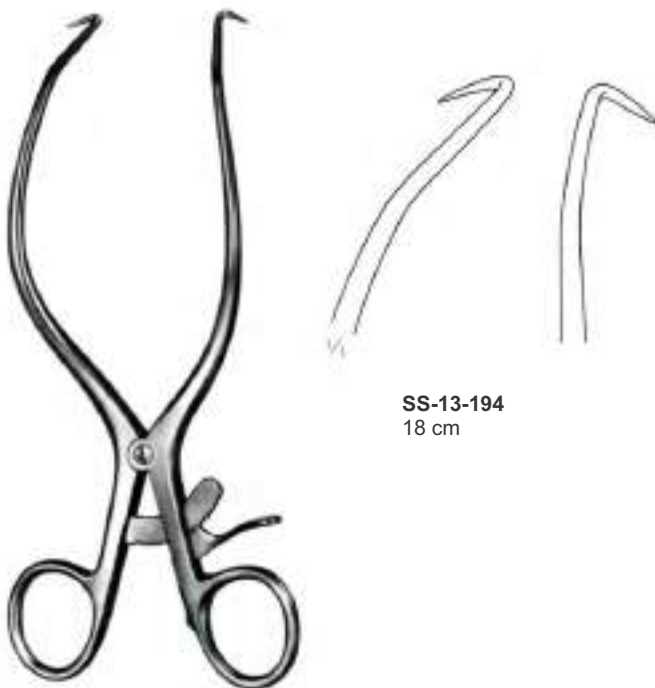

SS-13-194
18 cm

Gelpi

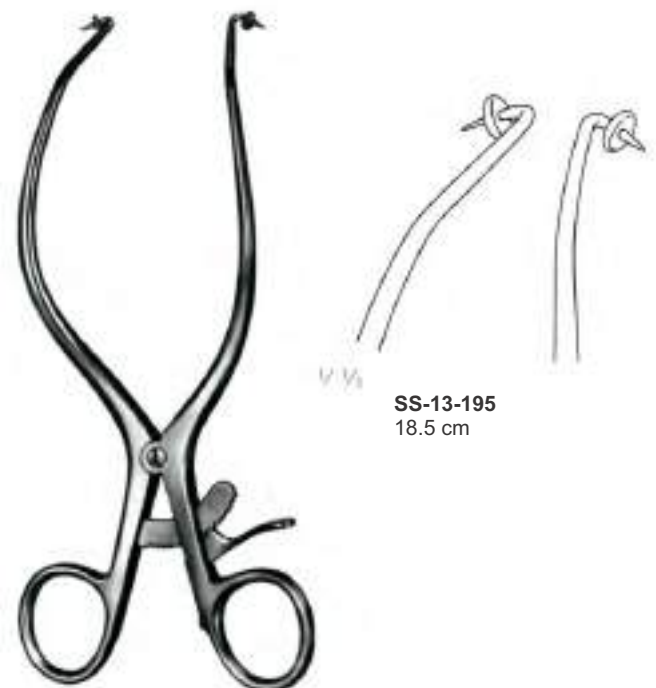

SS-13-195
18.5 cm

Gelpi

Abdominal Retractors
Separadores abdominales
Ecarteurs abdominaux



Ricard
SS-13-196A

SS-13-196
Central blade
Valva central
Valva central
55 x 70 mm



SS-13-198
Piece
Pieza
Piece

SS-13-197
Central blade
Valva central
Valva central
80 x 90 mm



SS-13-199
Piece
Pieza
Piece

Abdominal Retractors
 Separadores abdominales
 Ecarteurs abdominaux



Collin, Baby
SS-13-200
 20 cm



SS-13-201 **SS-13-202**



Walton
SS-13-203
 18 cm right
SS-13-204
 18 cm left



Collin
SS-13-205
 19 cm right
SS-13-206
 24 cm



Knighton
SS-13-205
 19 cm right
SS-13-206
 24 cm

Abdominal Retractors
Separadores abdominales
Ecarteurs abdominaux



Collin
SS-13-208
22.5 cm



Collin
SS-13-209
31 cm

Abdominal Retractors
Separadores abdominales
Ecarteurs abdominaux



Perman
SS-13-210
Abdominal retractor, Lateral valves
60 x 60 mm (AxB)

Separador abdominal, valvas Laterales
60 x 60 mm (AxB)

Ecarteur abdominal, valvas Laterales
60 x 60 mm (AxB)

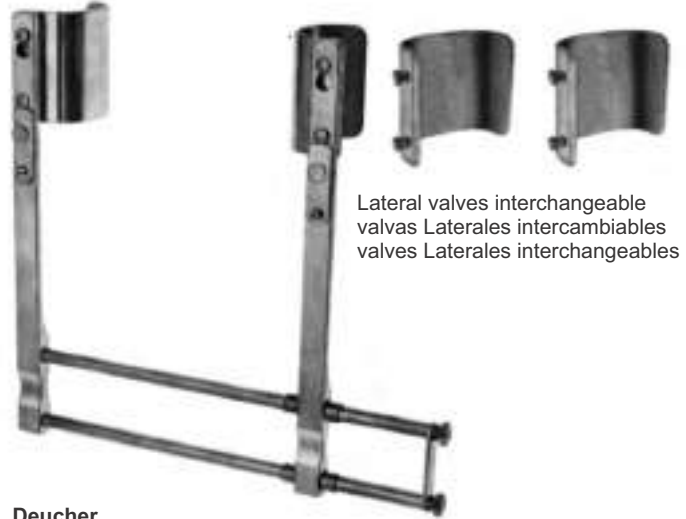

Deucher
SS-13-211
Abdominal retractor, complete, consisting of:
SS-13-212 1 Frame
SS-13-213 1 Pair lateral valves 52 x 60 mm (AxB)
SS-13-214 1 Pair lateral valves 64 x 60 mm (AxB)

Lateral valves interchangeable
valvas Laterales intercambiables
valves Laterales interchangeables

Separador abdominal, completo, compuesto de:

- SS-13-212** 1 Cuadro
- SS-13-213** 1 Par de valvas laterales 52 x 60 mm (AxB)
- SS-13-214** 1 Par de valvas laterales 64 x 60 mm (AxB)

Ecarteur abdominaux, complet, compose de:

- SS-13-212** 1 Cadre
- SS-13-213** 1 Paire de valvas laterales 52 x 60 mm (AxB)
- SS-13-214** 1 Paire de valvas laterales 64 x 60 mm (AxB)



Gosset-Baby
SS-13-215
Abdominal retractor, lateral valves
38 x 23 mm (AxB) & 38 x 31 mm (AxB)

Separador abdominal, valvas laterales
38 x 23 mm (AxB) y 38 x 31 mm (AxB)

Ecarteur abdominal, valvas laterales
38 x 23 mm (AxB) et 38 x 31 mm (AxB)



Gosset
SS-13-216
Abdominal retractor, lateral valves
63 x 29 mm (AxB) and 63 x 36 mm (AxB)

Separador abdominal, valvas laterales
63 x 29 mm (AxB) y 63 x 36 mm (AxB)

Ecarteur abdominal, valvas Laterales
63 x 29 mm (AxB) et 63 x 36 mm (AxB)

Abdominal Retractors
 Separadores abdominales
 Ecarteurs abdominaux



**Gosset
 SS-13-217**

Abdominal retractor, Lateral valves 63 x 29 mm (AxB) & 63 x 36 mm (AxB), with central valve 59 x 57 mm

Separador abdominal, valvas Laterales 63 x 29 mm (AxB) y 63 x 36 mm (AxB), con valva central 59 x 57 mm

Ecarteur abdominal, valves Laterales 63 x 29 mm (AxB) et 63 x 36 mm (AxB), avec valve centrale 59 x 57 mm



**Balfour-Baby
 SS-13-218**

Abdominal retractor, Lateral valves 27 x 23 mm (AxB) & 27 x 28 mm (AxB), with central valve 22 x 24 mm

Separador abdominal, valvas Laterales 27 x 23 mm (AxB) 27 x 28 mm (AxB), con valva central 22 x 24 mm

Ecarteur abdominal, valves Laterales 27 x 23 mm (AxB) et 27 x 28 mm (AxB), avec valve centrale 22 x 24 mm



**Balfour
 SS-13-219**

Abdominal retractor, Lateral valves 48 x 28 mm (AxB) & 48 x 39 mm (AxB), with central valve 48 x 78 mm

Separador abdominal, valvas Laterales 48 x 28 mm (AxB) y 48 x 39 mm (AxB), con valva central 48 x 78 mm

Ecarteur abdominal, valves Laterales 48 x 28 mm (AxB) et 48 x 39 mm (AxB), avec valve centrale 48 x 78 mm



**Balfour
 SS-13-220**

Abdominal retractor, Lateral valves 60 x 32 mm (AxB) & 60 x 38 mm (AxB), with central valve 48 x 78 mm

Separador abdominal, valvas Laterales 60 x 32 mm (AxB) y 60 x 38 mm (AxB), con valva central 48 x 78 mm

Ecarteur abdominal, valves Laterales 60 x 32 mm (AxB) et 60 x 38 mm (AxB), avec valve centrale 48 x 78 mm

Abdominal Retractors
Separadores abdominales
Ecarteurs abdominaux



**Balfour
SS-13-221**
Abdominal retractor, Lateral valves 100 x 32 mm (AxB) & 100 x 38 mm (AxB), with central valve 80 x 80 mm (**SS-13-207**)

Separador abdominal, valvas Laterales 100 x 32 mm (AxB) y 100 x 38 mm (AxB), con valve central 80 x 80 mm (**SS-13-207**)

Ecarteur abdominal, valves Laterales 100 x 32 mm (AxB) et 100 x 38 mm (AxB), avec valve central 80 x 80 mm (**SS-21-207**)



**Balfour
SS-13-222**
Abdominal retractor, Lateral valves 60 x 36 mm (AxB) with central valve 48 x 78 mm (**SS-13-209**)

Separador abdominal, valvas Laterales 60 x 36 mm (AxB) con valve central 48 x 78 mm (**SS-13-209**)

Ecarteur abdominal, valves Laterales 60 x 36 mm (AxB) avec valve centrale 48 x 78 mm (**SS-13-209**)



**Balfour
SS-13-223**
Abdominal retractor, Lateral valves 60 x 36 mm (AxB) with central valve 48 x 78 mm (**SS-13-211**)

Separador abdominal, valvas Laterales 60 x 36 mm (AxB) con valve central 48 x 78 mm (**SS-13-211**)

Ecarteur abdominal, valves Laterales 60 x 36 mm (AxB) avec valve centrale 48 x 78 mm (**SS-13-211**)



**Balfour
SS-13-224**
Abdominal retractor, Lateral valves 100 x 32 mm (AxB) & 100 x 38 mm (AxB), with central valve 100 x 64 mm (**SS-13-213**)

Separador abdominal, valvas Laterales 100 x 32 mm (AxB) y 100 x 38 mm (AxB), con valve central 100 x 64 mm (**SS-13-213**)

Ecarteur abdominal, valves Laterales 100 x 32 mm (AxB) et 100 x 38 mm (AxB), avec valve central 100 x 64 mm (**SS-21-213**)

Abdominal Retractors
Separadores abdominales
Ecarteurs abdominaux

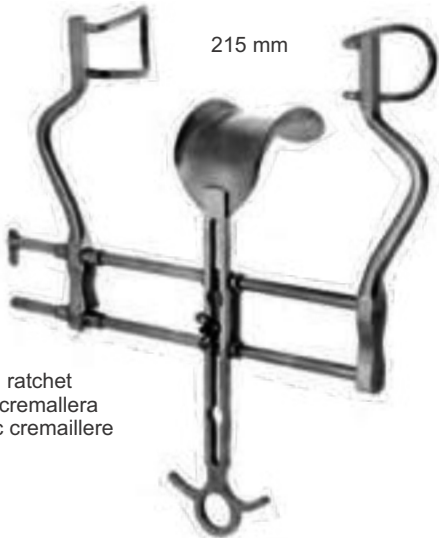

215 mm

With ratchet
con cremallera
avec cremaillere

Balfour modif.

SS-13-225

Abdominal retractor, Lateral valves 64 x 45 mm (AxB)
with central valve 70 x 66 mm (**SS-13-225-A**)

Separador abdominal, valvas Laterales 64 x 45 mm (AxB)
con valve central 70 x 66 mm(**SS-13-225-A**)

Ecarteur abdominal, valves Laterales 64 x 45 mm (AxB)
avec valve centrale 70 x 66 mm (**SS-13-225-A**)

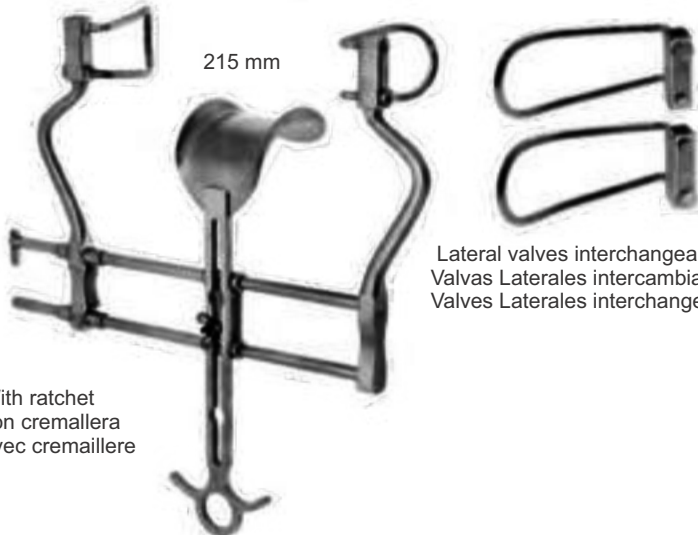

215 mm

With ratchet
con cremallera
avec cremaillere

Lateral valves interchangeable
Valvas Laterales intercambiables
Valves Laterales interchangeables

Balfour modif.

SS-13-226

Abdominal retractor, complete, consisting of:

SS-13-227 1 Frame

SS-13-228 1 Pair lateral valves 64 x 45 mm (AxB)

SS-13-229 1 Pair lateral valves 89 x 45 mm (AxB)

SS-13-230 1 Central valves 70 x 66 mm (AxB)

Separador abdominal, completo, compuesto de:

SS-13-227 1 Cuadro

SS-13-228 1 Par de valvas laterales 64 x 45 mm (AxB)

SS-13-229 1 Par de valvas lateraes 89 x 45 mm (AxB)

SS-13-230 1 Valve Central 70 x 66 mm (AxB)

Ecarteur abdominal, complet, compose de:

SS-13-227 1 Cadre

SS-13-228 1 Paire de valvas laterales 64 x 45 mm (AxB)

SS-13-228 1 Paire de valvas laterales 89 x 45 mm (AxB)

SS-13-230 1 valve Centrale 70 x 66 mm (AxB)

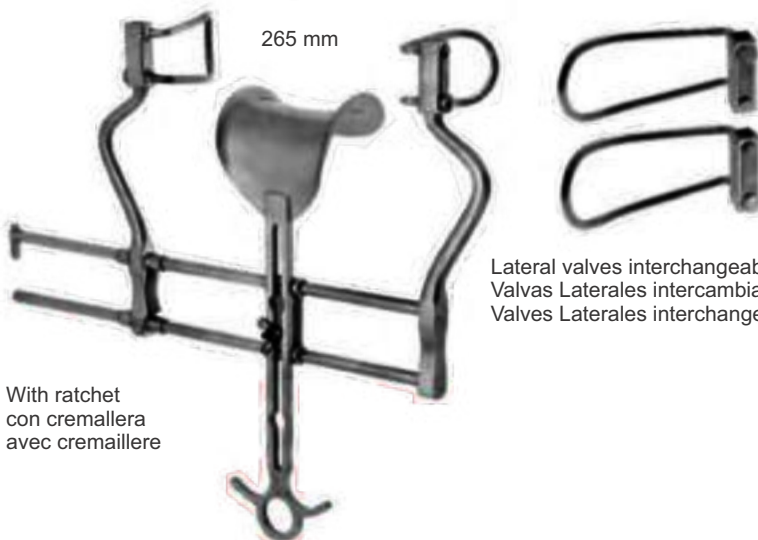

265 mm

With ratchet
con cremallera
avec cremaillere

Lateral valves interchangeable
Valvas Laterales intercambiables
Valves Laterales interchangeables

Balfour modif.

SS-21-231

Abdominal retractor, complete, consisting of:

SS-13-232 1 Frame

SS-13-233 1 Pair lateral valves 64 x 45 mm (AxB)

SS-13-234 1 Pair lateral valves 89 x 45 mm (AxB)

SS-13-235 1 Central valves 65 x 84 mm (AxB)

Separador abdominal, completo, compuesto de:

SS-13-232 1 Cuadro

SS-13-233 1 Par de valvas laterales 64 x 45 mm (AxB)

SS-13-234 1 Par de valvas lateraes 89 x 45 mm (AxB)

SS-13-235 1 Valves Central 65 x 84 mm (AxB)

Ecarteur abdominal, complet, compose de:

SS-13-232 1 Cadre

SS-13-233 1 Pair de valvas laterales 64 x 45 mm (AxB)

SS-13-234 1 Paire de valvas laterales 89 x 45 mm (AxB)

SS-13-235 1 valves Centrale 65 x 84 mm (AxB)

Abdominal Retractors
Separadores abdominales
Ecarteurs abdominaux



Balfour

SS-13-236 64 x 45 mm (AxB)
SS-13-237 89 x 45 mm (AxB)
SS-13-238 103 x 45 mm (AxB)

lateral valves, 1 pair, for abdominal retractors
SS-13-225 / SS-13-226 / SS-13-231

valves laterales, 1 par, para Separadores abdominales **SS-13-225 / SS-13-226 / SS-13-231**

valves laterales, 1 paire, pour ecarteurs abdominaux **SS-13-225 / SS-13-226 / SS-13-231**



Balfour

SS-13-239 70 x 66 mm (AxB)
SS-13-240 65 x 84 mm (AxB)
SS-13-241 45 x 93 mm (AxB)

Central valves for abdominal retractors
SS-13-225 / SS-13-226 / SS-13-231

valves centrales, para Separadores abdominales **SS-13-225 / SS-13-226 / SS-13-231**

valves centrales, pour ecarteurs abdominaux **SS-13-225 / SS-13-226 / SS-13-231**



Horgan

SS-13-242
183 x 51 mm (AxB)

Central valves, malleable, for abdominal retractors **SS-13-225 / SS-13-226 / SS-13-231**

valves centrales, maleable, para separadores abdominales **SS-13-225 / SS-13-226 / SS-13-231**

valve centrale, malleable, pour ecarteurs abdominaux **SS-13-225 / SS-13-226 / SS-13-231**



Balfour

SS-13-243 right derecho a droite
SS-13-244 left, izquierdo, a gauche

Side-arms for abdominal retractors
Brazos laterales para Separadores abdominales
Bras lateraux pour ecarteurs abdominaux

Abdominal Retractors
Separadores abdominales
Ecarteurs abdominaux



O' Sullivan-O'Connor

SS-13-245

Abdominal retractor, complete, consisting of:

- SS-13-246** 1 Frame with 2 lateral valves 62 x 25 mm (AxB)
- SS-13-247** 2 valves 81 x 46 mm (AxB)
- SS-13-248** 1 valve 110 x 72 mm (AxB)

Separador abdominal, completo, compuesto de:

- SS-13-246** 1 Cuadro con 2 valvas laterales 62 x 25 mm (AxB)
- SS-13-247** 2 valvas 81 x 46 mm (AxB)
- SS-13-248** 1 valva 110 x 72 mm (AxB)

Ecarteur abdominal, complet, compose de:

- SS-13-246** 1 Cadre avec 2 valvas laterales 62 x 25 mm (AxB)
- SS-13-247** 2 valvas 81 x 46 mm (AxB)
- SS-13-248** 1 valva 110 x 72 mm (AxB)

Franz

SS-13-249

Abdominal retractor, complete, consisting of:

- SS-13-250** 1 Folding frame 220 x 220 mm
- SS-13-251** 2 valves 40 x 62 mm (AxB)
- SS-13-252** 2 valves 43 x 80 mm (AxB)
- SS-13-253** 2 valves 48 x 65 mm (AxB)
- SS-13-254** 2 valves 46 x 91 mm (AxB)

Separador abdominal, completo, compuesto de:

- SS-13-250** 1 Cuadro plegable 220 x 220 mm
- SS-13-251** 2 valvas 40 x 62 mm (AxB)
- SS-13-252** 2 valvas 43 x 80 mm (AxB)
- SS-13-253** 2 valvas 48 x 65 mm (AxB)
- SS-13-254** 2 valvas 46 x 91 mm (AxB)

Ecarteur abdominal, complet, compose de:

- SS-13-250** 1 Cadre pliant 220 x 220 mm
- SS-13-251** 2 valvas 40 x 62 mm (AxB)
- SS-13-252** 2 valvas 43 x 80 mm (AxB)
- SS-13-253** 2 valvas 48 x 65 mm (AxB)
- SS-13-254** 2 valvas 46 x 91 mm (AxB)

Abdominal Retractors
Separadores abdominales
Ecarteurs abdominaux



Denis-Browne
SS-13-255

Abdominal retractor, complete, consisting of:
SS-13-256 1 Frame 180 x 150 mm
SS-13-257 2 Valves 40 x 30 mm (AxB)
SS-13-258 2 Valves 40 x 40 mm (AxB)

Separador abdominal, completo, compuesto de:
SS-13-256 1 Cuadro 180 x 150 mm
SS-13-257 2 Valvas 40 x 30 mm (AxB)
SS-13-258 2 Valvas 40 x 40 mm (AxB)

Ecarteur abdominal, complet, compose de:
SS-13-256 1 Cadre 180 x 150 mm
SS-13-257 2 Valves 40 x 62 mm (AxB)
SS-13-258 2 Valves 40 x 80 mm (AxB)

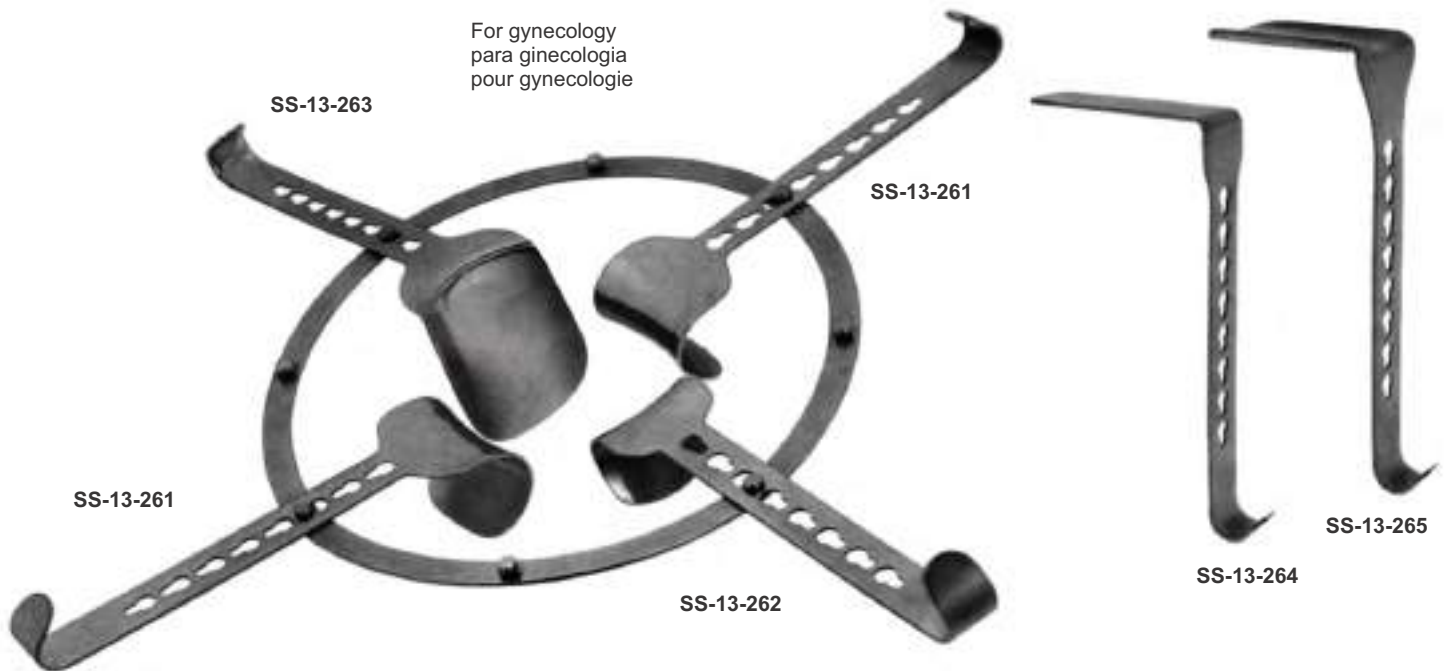

Semm
SS-13-259

Abdominal retractor, complete, consisting of:

SS-13-260 1 Frame 275 x 250 mm
SS-13-261 2 Valves 47 x 65 mm (AxB)
SS-13-262 1 Valve for bladder 50 x 54 mm (AxB)
SS-13-263 1 Valve for intestine 76 x 98 mm
SS-13-264 1 Valve for intestine 98 x 52 mm (AxB)
SS-13-265 1 Valve 105 x 35 mm (AxB)

Separadores abdominal, complet, compuesto de:

SS-13-260 1 Cadre 275 x 250 mm
SS-13-261 2 Valves 47 x 65 mm (AxB)
SS-13-262 1 Valva para vejiga 50 x 54 mm (AxB)
SS-13-263 1 Valva para intestino 76 x 98 mm
SS-13-264 1 Valva para intestino 98 x 52 mm (AxB)
SS-13-265 1 Valva 105 x 35 mm (AxB)

Ecarteur abdominal, complet, compose de:

SS-13-260 1 Cadre 275 x 250 mm
SS-13-261 2 Valves 47 x 65 mm (AxB)
SS-13-262 1 Valve pour vessie 50 x 54 mm (AxB)
SS-13-263 1 Valve pour intestin 76 x 98 mm
SS-13-264 1 Valve pour intestin 98 x 52 mm (AxB)
SS-13-265 1 Valve 105 x 35 mm (AxB)

Abdominal Retractors
Separadores abdominales
Ecarteurs abdominaux

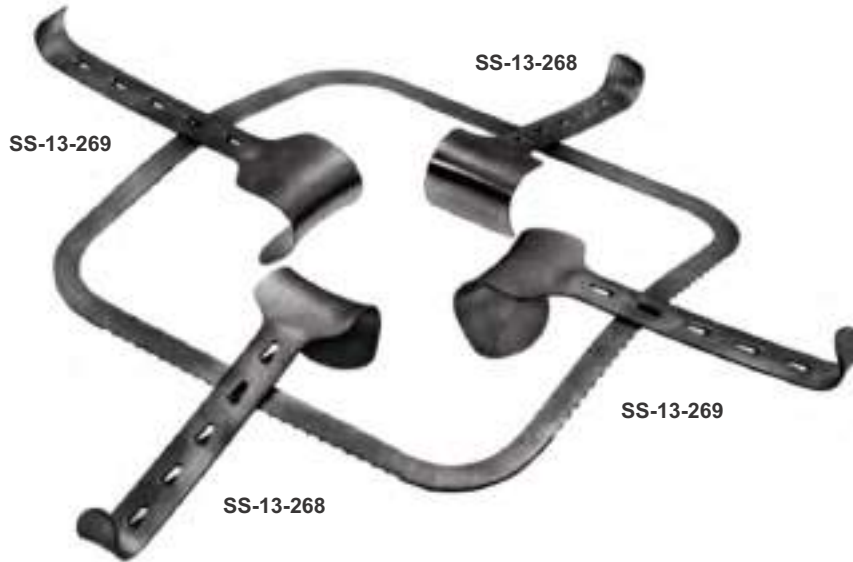

Kirschner
SS-13-266

Abdominal retractor, complete, consisting of:

- SS-13-267** 1 Fixed Frame 250 x 250 mm
- SS-13-268** 2 Valves 43 x 55 mm (AxB)
- SS-13-269** 2 Valves 48 x 65 mm (AxB)

Separador abdominal, completo, compuesto de:

- SS-13-267** 1 Cuadro fijo 250 x 250 mm
- SS-13-268** 2 Valvas 43 x 55 mm (AxB)
- SS-13-269** 2 Valvas 48 x 65 mm (AxB)

Ecarteur abdominal, complet, compose de:

- SS-13-267** 1 Cadre fixe 250 x 250 mm
- SS-13-268** 2 Valves 43 x 55 mm (AxB)
- SS-13-269** 2 Valves 48 x 65 mm (AxB)



Kirschner
SS-13-270

Abdominal retractor, complete, consisting of:

- SS-13-271** 1 Folding Frame 255 x 255 mm
- SS-13-272** 2 Valves 43 x 55 mm (AxB)
- SS-13-273** 2 Valves 48 x 65 mm (AxB)

Separador abdominal, completo, compuesto de:

- SS-13-271** 1 Cuadro plegable 255 x 255 mm
- SS-13-272** 2 Valvas 43 x 55 mm (AxB)
- SS-13-273** 2 Valvas 48 x 65 mm (AxB)

Ecarteur abdominal, complet, compose de:

- SS-13-271** 1 Cadre pliant 255 x 255 mm
- SS-13-272** 2 Valves 43 x 55 mm (AxB)
- SS-13-273** 2 Valves 48 x 65 mm (AxB)

Abdominal Retractors
Separadores abdominales
Ecarteurs abdominaux



Kirschner
SS-13-274 43 x 55 mm (AxB)
SS-13-275 48 x 65 mm (AxB)
SS-13-276 80 x 90 mm (AxB)
SS-13-277 90 x 65 mm (AxB)
SS-13-278 98 x 95 mm (AxB)



Kirschner-Balfour
SS-13-279
 83 x 82 mm (AxB)



Kirschner
SS-13-280
 60 x 82 mm (AxB)



Kirschner
SS-13-281 98 x 51 mm (AxB)
SS-13-282 105 x 38 mm (AxB)

Abdominal Retractors
Separadores abdominales
Ecarteurs abdominaux



Foerster
SS-13-283

Abdominal retractor, made of NYLON, Transparent to X-ray, sterilizable only in the autoclave at 2 bar over-pressure (134°C), complete, consisting of:

SS-13-284 1 Frame 255 x 255 mm

SS-13-285 4 Valves 51 x 64 mm (AxB)

Separador abdominal , de NILON, transparente a los rayos-x, esterilizable solamente en autoclave a 2 bar sobresion (134°C), completo, compuesto de:

SS-13-284 1 Cuadro 255 x 255 mm

SS-13-285 4 Valvas 51 x 64 mm (AxB)

Ecarteur abdominal , en VINYL, transparent aux rayons X sterilisable en autoclave a 2 bar (134°C) seulement, complet, compose de:

SS-13-284 1 Cadr 255 x 255 mm

SS-13-285 4 Valves 51 x 64 mm (AxB)



Foerster
SS-13-285

51 x 64 mm (AxB)

Valve, made of NYLON, for Abdominal retractor, (SS-13-283)

Valva, de NILON, para separador Abdominal (SS-13-283)

Valve, VINYL, para ecarteur Abdominal (SS-13-283)



Foerster
SS-13-286

78 x 65 mm (AxB)

Valve, made of NYLON, for Abdominal retractor, (SS-13-283)

Valva, de NILON, para separador Abdominal (SS-13-283)

Valve, VINYL, para ecarteur Abdominal (SS-13-283)



Foerster
SS-13-287

Spare button, made of NYLON, for fro frame, (SS-13-283)

Boton de repuesto, de NILON para cuadro (SS-13-283)

Bouton VINYL, pour cadre (SS-13-283)

Abdominal Retractors
Separadores abdominales
Ecarteurs abdominaux



Rochard
SS-13-288 50 x 90 (AxB)
SS-13-289 50 x 105 (AxB)
SS-13-290 50 x 120 (AxB)
SS-13-291 50 x 135 (AxB)
SS-13-292 50 x 155 (AxB)
 29 cm
 Abdominal retractors
 Separadores abdominales
 Ecarteur abdominal



Rochard
SS-13-293
 19.5 cm
 Fixation device for 20-1015 - 20-1019
 Dispositivo de fijacion para 20-1015 - 20-1019
 Compas articule pour 20-1015 - 20-1019



Doyen
SS-13-295 95 x 60 (AxB)
SS-13-296 105 x 65 (AxB)
SS-13-297 115 x 65 (AxB)
SS-13-298 125 x 65 (AxB)
 28 cm



Doyen
SS-13-294

Abdominal Retractors
Separadores abdominales
Ecarteurs abdominaux



Millin

SS-13-299

21.5 cm

Bladder retractor, complete, consisting of:

- SS-13-300** 1 Spreader
- SS-13-301** 1 Pair lateral Valves 57 x 25 mm (AxB)
- SS-13-302** 1 Pair lateral Valves 80 x 25 mm (AxB)
- SS-13-303** 1 Central Valve 120 x 45 mm (AxB)

Separador para la vejiga , completo, compuesto de:

- SS-13-300** 1 Separador
- SS-13-301** 1 Par de Valvas laterales 57 x 25 mm (AxB)
- SS-13-302** 1 Par de Valvas laterales 80 x 25 mm (AxB)
- SS-13-303** 1 Valve central 120 x 45 mm (AxB)

Ecarteur vesical, complet, compose de:

- SS-13-300** 1 Ecarteur
- SS-13-301** 1 Pair de Valvas laterales 57 x 25 mm (AxB)
- SS-13-302** 1 Pair de Valvas laterales 80 x 25 mm (AxB)
- SS-13-303** 1 Valve central 120 x 25 mm (AxB)



Judd-Masson

SS-13-304

Bladder & suprapubic retractor, complete, consisting of:

- SS-13-305** 1 Frame with 2 valves 70 x 25 mm (AxB)
- SS-13-306** 1 Central valve 84 x 24 mm (AxB)

Separador para la vejiga y la prostatectomia suprapubica , completo, compuesto de:

- SS-13-305** 1 Cuadro con 2 valvas laterales 70 x 25 mm (AxB)
- SS-13-306** 1 Central valve 84 x 24 mm (AxB)

Ecarteur pour la vessie et prostatectomie, complet, compose de:

- SS-13-305** 1 Cadre avec 2 valvas laterales 70 x 25 mm (AxB)
- SS-13-306** 1 Valve centrale 84 x 24 mm (AxB)



Millin

SS-13-307

21.5 cm

Bladder retractor, complete, consisting of:

- SS-13-308** 1 Frame
- SS-13-309** 1 Pair lateral Valves 50 x 22 mm (AxB)
- SS-13-310** 1 Pair lateral Valves 63 x 22 mm (AxB)
- SS-13-311** 1 Central Valve 120 x 52 mm (AxB)

Separador para la vejiga , completo, compuesto de:

- SS-13-308** 1 Cuadro
- SS-13-309** 1 Par de Valvas laterales 50 x 22 mm (AxB)
- SS-13-310** 1 Par de Valvas laterales 63 x 22 mm (AxB)
- SS-13-311** 1 Valve central 120 x 52 mm (AxB)

Ecarteur vesical, complet, compose de:

- SS-13-308** 1 Ecarteur
- SS-13-309** 1 Pair de Valvas laterales 57 x 25 mm (AxB)
- SS-13-310** 1 Pair de Valvas laterales 63 x 22 mm (AxB)
- SS-13-311** 1 Valve central 120 x 52 mm (AxB)

Self Retaining Retractors
Separadores autostaticos
Ecarteurs autostiques



Caspar
SS-13-312 17 cm
complete - left
SS-13-312 17 cm
only

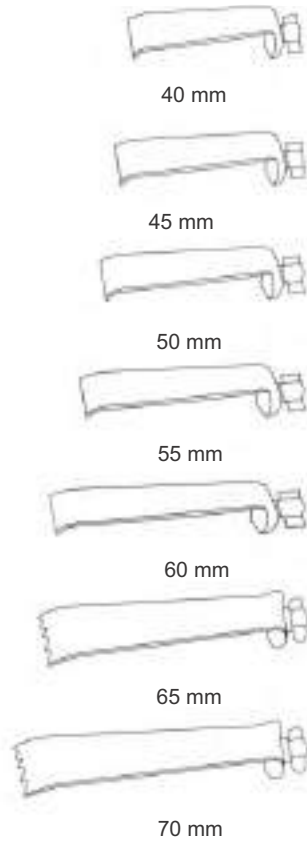

70 x 38 mm 57 x 38 mm



Darling
SS-13-314 16.5 cm
left
SS-13-3152 16.5 cm
right



Rigby
SS-13-316
18 cm



Quervain
SS-13-317

SS-13-318
(pair)
Lateral Blades only
60 x 60 mm



SS-13-319
(pair)
Lateral Blades only
50 x 30 mm

Retractors For Cervical Vertebral Column
 Separadores para la columna cervical
 Ecarteurs pour colonne vertebrale

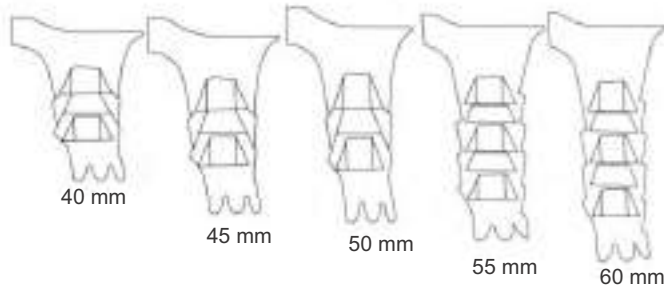

Caspar
 SS-13-320



Caspar
 SS-13-321
 17 cm
 complete - right
 SS-13-322
 17 cm
 only

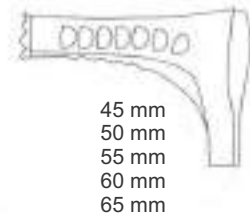
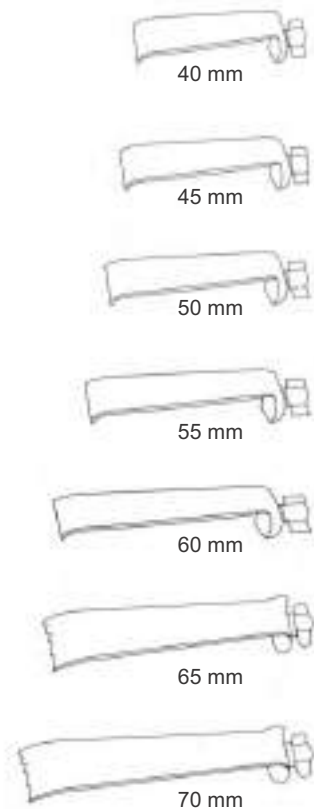

Caspar
 SS-13-323

Retractors For Cervical Vertebral Column
Separadores para la columna cervical
Ecarteurs pour colonne vertebrale



Cloward
SS-13-324
15 cm / 6"



Cloward
SS-13-325
17 cm / 6¾"



Cloward
SS-13-326
16 cm

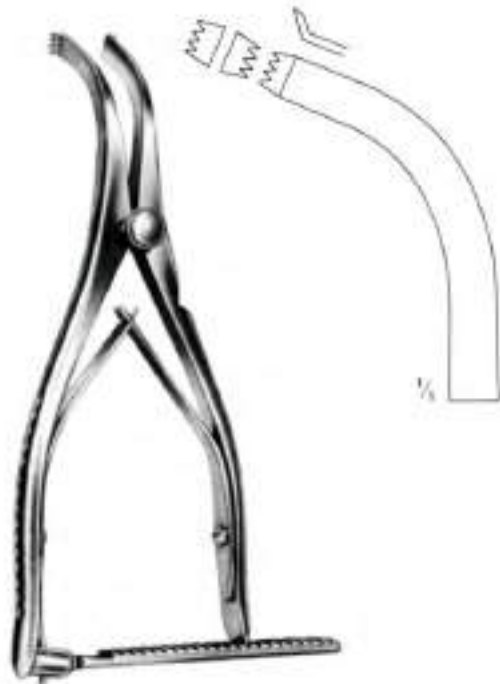

Inge
SS-13-327
16.5 cm / 6½"



SAPTESTAR
Manufacturer & Exporter Of Surgical, Dental & Veterinary Instruments

Retractors For Cervical Vertebral Column
Separadores para la columna cervical
Ecarteurs pour colonne vertebrale

2 flat jaws
bocas llanas
mors plats



Inge - flat
SS-13-328
24 cm / 9½"
Blade opening 50 mm / 2"
Abertura de la hoja 50 mm
Ecartement 50 mm

2 cupped jaws
bocas forma de copa
mors forme cuiller



Inge - curved
SS-13-329
24 cm / 9½"
Blade opening 50 mm / 2"
Abertura de la hoja 50 mm
Ecartement 50 mm

serrated jaws
bocas estriadas
mors stries



SS-13-330
28 cm / 11"
Blade opening 75 mm / 3"
Abertura de la hoja 75 mm
Ecartement 75 mm

Retractors For Cervical Vertebral Column
Separadores para la columna cervical
Ecarteurs pour colonne vertebrale



Caspar
SS-13-331
complete 5 blades
SS-13-332
11.5 cm
only
opening 8.5 cm



45 x 23 mm (AxB)



50 x 23 mm (AxB)



55 x 23 mm (AxB)



60 x 23 mm (AxB)



65 x 23 mm (AxB)



SAPTESTAR

Manufacturer & Exporter Of Surgical, Dental & Veterinary Instruments



+92-340-4040061



exportsaptestar@gmail.com



info@saptestar.com



www.saptestar.com



Defence Road, Near Hotel Javson, 51310-Sialkot Pakistan





SAPTESTAR

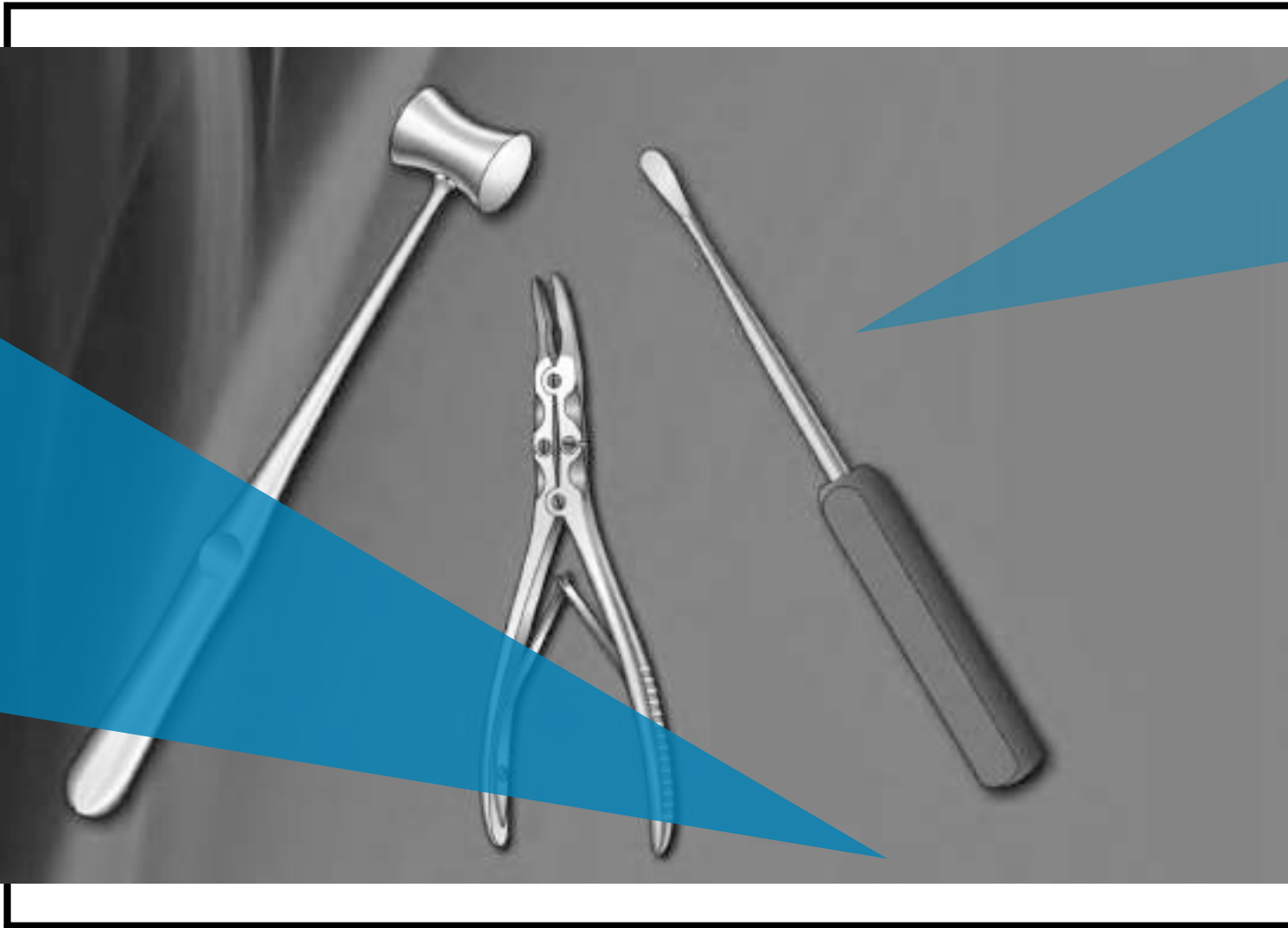

**Manufacturers & Exporters Of Quality Surgical Instruments
Orthopedic Instruments Catalogue**

Group 14

Bone Surgery 14



+92-340-4040061



exportsaptestar@gmail.com



info@saptestar.com



www.saptestar.com



Defence Road, Near Hotel Javson, 51310-Sialkot Pakistan

Company Profile



ABOUT US

Quality begins at **SapteStar** Instruments Company where master craftsmen forge and manufacture each instrument to its exact specifications and measurements. Instruments must undergo a series of quality control inspections in order to be worthy of **SapteStar** name and warranty. We offer a wide selection of medical instruments including Surgical and Dental instruments.

We have acquired a unique and unmatched understanding of manufacturing through a large experience, working since 1908. Years of experience & state of the art manufacturing facilities helped us to keep our prices low. Our Surgical & Dental instruments are created by expert craftsmen, providing unfaltering quality you can rely on.

We have launched a fully interactive website where you can get online and track your orders 24 hours a day, 7 days in a week, and 365 days a year. Ask for our free e-catalogue on CD-Rom to save time and enjoy hassle free ordering.

We provide our customers with most reliable customer service as your satisfaction is our top priority. Our customers always enjoy our wonderful customer service and quality tools at the best price.

Lastly we invite you to have a work experience with SapteStar Instruments Company and we will prove ourselves as one of the most valuable source you have.

You can find us at

SapteStar
CEO



Company Profile



History

SAPTESTAR INSTRUMENTS was founded in 1995. Our Great Grandfather **Mian Muhammad Fazal Elahi** was the founder of M/s M.F. Elahi & Company (E.P.) Pvt. Ltd, established in 1908. SapteStar is a sister concern of M.F. Elahi & Co. It is our pride to be a member of M.F. Elahi Family.

SapteStar Instruments Company is located in the heart of beautiful city, Sialkot, Pakistan. We are manufacturers and exporters of quality Surgical, Dental instruments and Scissors of all sorts in various categories. We are closely attached with highly skilled surgeons and other technicians of the surgical industry to make the new instruments development possible.

SapteStar is in a continues process of development and testing of new instruments for their precision and perfect functioning. We are also working at imported forging supply by foreign customers.

Certificates

Instruments Company has achieved the certificates for ISO-9001, ISO-13485, cGMP (FDA) and CE Marking.

Quality Control

All material use in the manufacturing of our instruments are tested from relevant laboratories. Our continuous quality control is our best warranty so that you built confidence in our products.

Deliveries

Deliveries are quick and in-time.

Mode Of Payment

Terms of Payment is ADVANCE or LETTER OF CREDIT (Irrevocable)



Bone Surgery 14

14 Bone Surgery

Adson	77, 12	Gerster	9
Alderdyce	62	Gouge For Removing Broken Screw	87
Alexander Osteotome	86	Gouge	88-93
Aufricht	81	Hackstock With Longitudinal	39
Barth	52	Halle	57, 70
Bending And Cutting Plier	32	Hemingway	52
Bending Plier	32	Hoehn	74
Bennett Bone Lever	69	Hohmann	66-68
Beyer	11, 13	Hohmann Bone Lever	68
Becon	12	Hohmann-Aldinger	68
Bier	57, 61	House	51
Bircher	27	Hoke	84
Bircher-Ganske Forcep	19, 24	Howard	71
Blount Bone Lever	68	Hudson (Hand Drill)	33
Blount Retractor	20, 25	Jackson	29
Blumenthal	10	Jacobs	34
Bohler	13, 43	Jansen	11, 75, 52
Bone Curette Swedish Pattern	53	Joseph Bone Flies	80, 87
Bone Files	78, 79	Joseph Raspatories	70
Bone Lever	60	Kazanjian	20
Brand Tendon Holding Forcep	25, 30	Kern-Lane	4
Brawley	81	Kern-Mini	4
Bruns	50-51, 56	Key Raspatorie	77
Buck-Gramcko	61, 64	Killian Raspatories	71
Canad-Modell	27	Kleinert-kutz	12
Caspar	73	Konig	70
Carroll	31	Koppelman-Leibinger	36
Charriere Resection Saw	56	Krischner With Traction Hook	43
Charriere	60	Lambotte Osteotome	5, 6
Chisel	80, 82, 85-87	Lowman	9
Cleveland	16, 20	Lowman-Lambert	9
Cobb Spinal Gouges	89	Lowman-Hoglund	9
Cobb	59, 73, 77-79	Lambotte	6, 85
Collin Mallet	46	Landolt	73
Combi-Flat Nose Plier	33	Lane	4
Cottle Mallet	41	Lange-Hohmann	65
Cottle Osteotomes	81	Langenbeck Amputation	60
Cottle	46, 73, 85	Langenbeck Bone Holding	3, 63
Daubenspeck	52	Langenbeck Elevator	75
Demel Wire Guides	37	Langenbeck	3, 75, 60
Demel	44	Leksell-Stille	15
Dingmann	3	Leksell	17
Doyen	45	Lempert	10, 11, 52, 57
Echlin	14	Lewin	1
Extension Bows	37, 39	Lewis	80
Farabeuf	76	Lexer Gouge	90
Farabeuf-Collin	76	Lexer Osteotome	90, 89
Farabeuf-Lambotte	5	Lexer Spongiosa Gouge	92
Fergusson	3	Liston	20, 22
Finger Ring Saw	23	Littauer-Liston	20
Fisch	12	Listen Key	23
Flat Nose Plier Pointed	34	Loute Wire Tightner	42
Flat Nose Plier	33	Lowman09	9
Fomom	83	Lowman-Hoglund	9
Freer Chisel	80	Lowman-Hambert	9
Freer	84	LucaeMallet	46
Frykholm	15	Lucas	52
Gallaher	80	Luer	11, 10



14 Bone Surgery

Luer-Friedman	10	Sebileau	63
Luer-Stille	14,16	Sedillot	74
Mallet Made Of Plastic Without Lead	43	Self-Centering With Thread	7
Mallet Plastic Handle	44	Semb	18, 23
Maltz Raspatorie	77	Sequestrum Forcep	2
Marquardt	14, 81	Sewall	70
Martin Meniscus Forcep	19	Simon	58
Martin "Gigant- Compact	35	Smillie Knife	27, 25
Martin Cutter Front Action	35	Smillie Retractor	27
Martin Wire Twisting Forcep	31	Smith-Peterson	17
Martin	29, 24, 34, 36	Spongiosa Gouge	88
Martini	40, 46	Spratt	55
Mayfield	51	Steinmann	29
Mc Donald	58	Stellbring	11
Mc Indoe	17, 21, 62	Stille Chisel	87
Mc Kenty Raspatories	66	Stille Drill	32
Mead Mallet	47	Stille Gouge	87
Mead	10	Stille Osteotome	87
Miller	80	Stille	87, 32
Mini-Hohmann	64	Stille-Liston	23
Mini-Lambotte	85	Still-Luer	18
Mini-Lexer	90	Still-Ruskin	16
Modelling Plier	32	Stille-sherman (Hand Drill)	32
Mod-Usa Curette	49	Tendon Interlacing Forcep	31
Mod-Usa	54	Tendon Seizing Forcep	30
Moore (Hand Drill)	35	Trelat	70
Muhking	72	TC H/Gold	37
Murphy-Lane	69	Uffenorde	54
Nail Splitting Forcep	23	Ulrich	6
Neff Meniscus Knife	21	Van Buren	2
Olivecrona	12, 26	Verbrugge With Lip Joint	8
Osteotome Set With Blade	84	Verbrugge=Muller Bone Lever	67
Osteotome	80-82	Vickers Mallet	50
Partsch Mallet Made Of Plastic	47	Volkman Bone Curette	53, 50
Percy Amputation Retractors	55	Volkman Spoon	50, 55
Peiper-Beyer	18	Volkman Artificial Wood Handle	59
Petella Forcep	02	Waginer	65
Plastic Handle Mallets	44-45	Wagner	79
Plate Cutter	32	Walton-Liston(Bohler)	21
Putti Bone Files	82	Watson-Cheyne Dissector	62
Quervain	63	Watson-william	81
Radolf Nail Extracting Forcep	28	West	84
Raspatories With Artificial Handle	74	West Gouge	84
Resposition Forcep	1	Wiener	81
Resposition	1, 2	Williger Elevator	47, 45
Rottgen-Ruskin	16	Williger Mallet	62
Ruskin Bone Cutter	17	Williger	45, 47, 53, 54, 62, 70
Ruskin	13, 14, 21	Wire Cutting Plier For Soft	41, 40-44
Ruskin-liston	17, 21	Wire Cutting Pliers	37, 44, 41, 40
Rust	26, 61	Wire Twisting Forcep T/Carbide	36
Salenius Knife	21	With Crosswise Groove Plier	39
Sauerbruch-Still	19	Zaufal-jansen	13
Sauerbruch-Coryllos	19	Zielke Gouge For Scoliosis Operation	91
Satterlee	56, 60		
Schede	50		
Schell	12		
Schneider	76		
Schneider-Sauerbruch	76		

Reposition Forceps
 Pinzas para reduccion
 Pinces a reduction



SS-14-101
 13.5 cm
 for maxillary reposition
 para la reduccion maxilar
 Pour reposition du maxilaire



SS-14-102
 13 cm
 for small fragments
 para fragmentos pequenos
 Pour petits fragments



SS-14-103
 20.5 cm



SS-14-104
 13.5 cm



SS-14-105
 14 cm



Lewin
SS-14-106
 17.5 cm



SAPTESTAR
Manufacturer & Exporter Of Surgical, Dental & Veterinary Instruments

Sequestrum Forceps Reposition Forceps,
Pinzas para reduccion, Pinzas para secuestro
Pinces a reduction, Pinces a sequestre



SS-14-107
17 cm
Reposition forceps
Pinza para reduccion
Pince a reduction



SS-14-108
24 cm
Reposition forceps
Pinzas para reduccion
Pinces a reduction
Pince a reduction



SS-14-109
18.5 cm
Patella forceps
Pinzas para rotula
Pince patella
Pinza per rotula



SS-14-110
20 cm
Sequestrum forceps
Pinzas para secuestro
Pinza a sequestre



SS-14-111
20 cm
Sequestrum forceps
Pinzas para secuestro
Pinza a sequestre



Van Buren
SS-14-112
20 cm
Sequestrum forceps
Pinzas para secuestro
Pinza a sequestre

Bone Holding Forceps
 Pinzas para huesos
 Daviers



Dingmann
SS-14-113
 18.5 cm



Dingmann modif.
SS-14-114
 18.5 cm



SS-14-115
 20 cm



Langenbeck
SS-14-116
 19.5 cm



Fergusson
SS-14-117
 20.5 cm

Bone Files, Rasps
Limas para huesos, Escofinas
Limes a os, Rapes

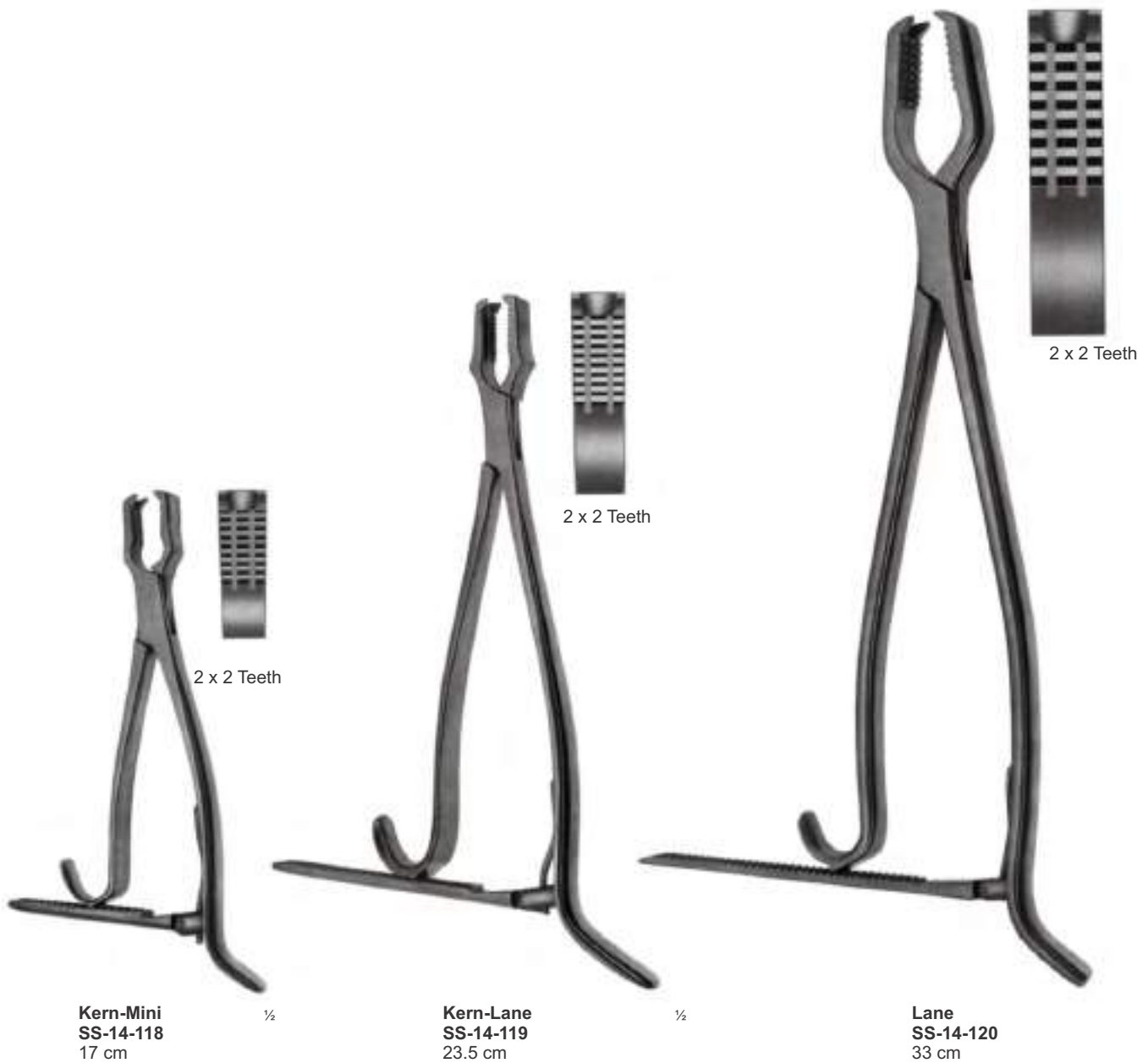

Bone Holding Forceps
 Pinzas para huesos
 Daviers



Farabeuf-Lambotte
SS-14-121
 25.5 cm
 Adjustable
 ajustable
 a cremaillere



Lambotte
 Adjustable, 1 jaw swiveled
 ajustable, a mandibula, movable
 a cremaillere, 1 mors mobile



9 mm

SS-14-122
 22 cm



10 mm

SS-14-123
 27 cm



11 mm

SS-14-124
 30.5 cm

Bone Holding Forceps
Pinzas para huesos
Daviers



14 mm



Lambotte
SS-14-125
21 cm
adjustable, 1 jaw swiveled
ajustable, 1 mandibula movable
a cremallere, 1 mors mobile



Ulrich



5.0 mm

SS-14-126
18 cm



7.5 mm

SS-14-127
23 cm



8.0 mm

SS-14-128
25 cm



8.5 mm

SS-14-129
28 cm

Bone Holding Forceps
Pinzas para huesos
Daviers



2.5 mm



SS-14-130
15 cm

6.5 mm



SS-14-131
19 cm

9.5 mm



SS-14-132
24 cm

10.0 mm



SS-14-133
26 cm

11.0 mm



SS-14-134
28 cm



Self-centring forceps with thread fixation
autocentrante con cremallera de tuerca
autostatique, a cremaillere

Bone Holding Forceps
Pinzas para huesos
Daviers



6 mm



SS-14-135
17.5 cm

9 mm



SS-14-136
25 cm

12.5 mm



SS-14-138
27 cm

11.5 mm



SS-14-137
26.5 cm



Verbrugge

with lip joint
con cierre de labio

Bone Holding Forceps
Pinzas para huesos
Daviers



Lowman
SS-14-139 12 cm
SS-14-140 18 cm
SS-14-141 21 cm



Lowman
SS-14-142 12 cm
SS-14-143 18 cm
SS-14-144 21 cm



Lowman-lambert
SS-14-145
21 cm



Lowman-Hoglund
SS-14-146
18 cm
1 jaw swiveled
1 mandibula movable
1 mors mobile



Gerster
SS-14-147
Traction bar for bone clamps
Barra de traccion para pinzas porta-huesos
Tracteur pour daviers

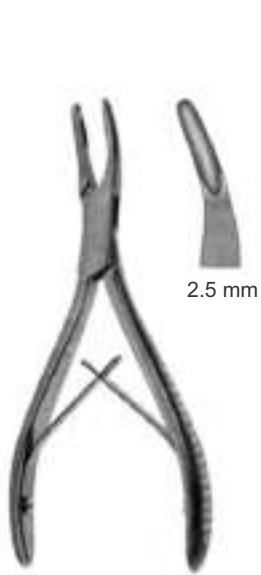

Luer-Friedman
SS-14-148
 13 cm

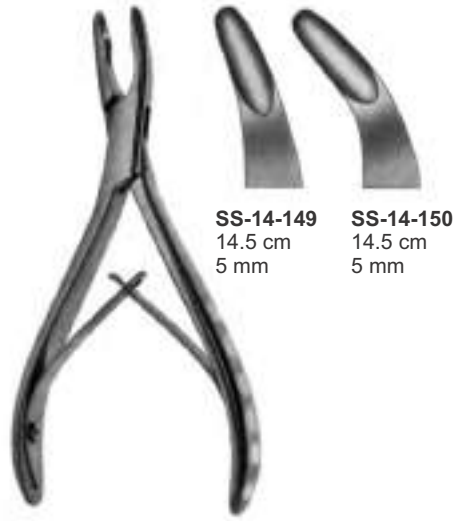

Luer

SS-14-149
 14.5 cm
 5 mm

SS-14-150
 14.5 cm
 5 mm



Lempert

SS-14-151
 15.5 cm
 3 mm

SS-14-152
 15.5 cm
 3 mm



Blumenthal

SS-14-153
 15.5 cm
 4 mm



SS-14-154
 15.5 cm
 4 mm

SS-14-155
 15.5 cm
 4 mm

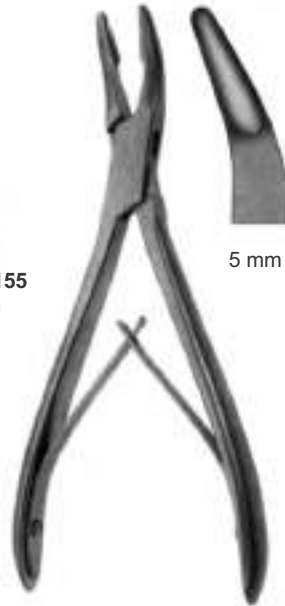

Mead
SS-14-156
 16.5 cm

5 mm



Mead
SS-14-157
 16.5 cm

5 mm

Bone Rongeurs
Pinzas-gubias
Pinces-gouges



SS-14-158 17.5 cm
2 mm

SS-14-159 17 cm
2 mm

Stellbring

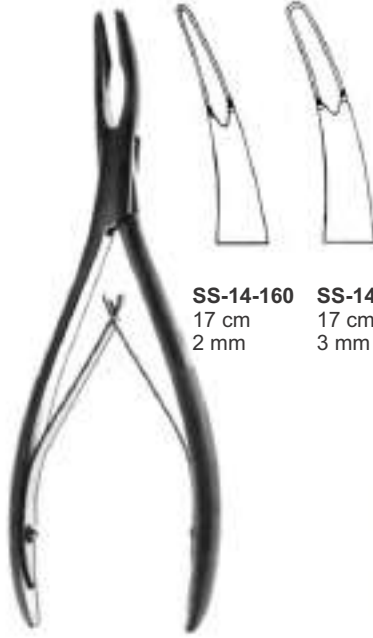

SS-14-160 17 cm
2 mm

SS-14-160A 17 cm
3 mm

Beyer



SS-14-161 17.5 cm
4 mm

SS-14-162 17.5 cm
4 mm

Jansen



SS-14-163 18 cm
3 mm

SS-14-164 18 cm
3 mm

Lempert



4 mm

Jansen
SS-14-165
19 cm



SS-14-166 18 cm
10 mm

SS-14-167 18 cm
10 mm

Luer



SAPTESTAR
Manufacturer & Exporter Of Surgical, Dental & Veterinary Instruments

Bone Rongeurs
Pinzas-gubias
Pinces-gouges



Adson
SS-14-168
21 cm



Bacon
SS-14-169
20 cm



Olivecrona
SS-14-170
20 cm

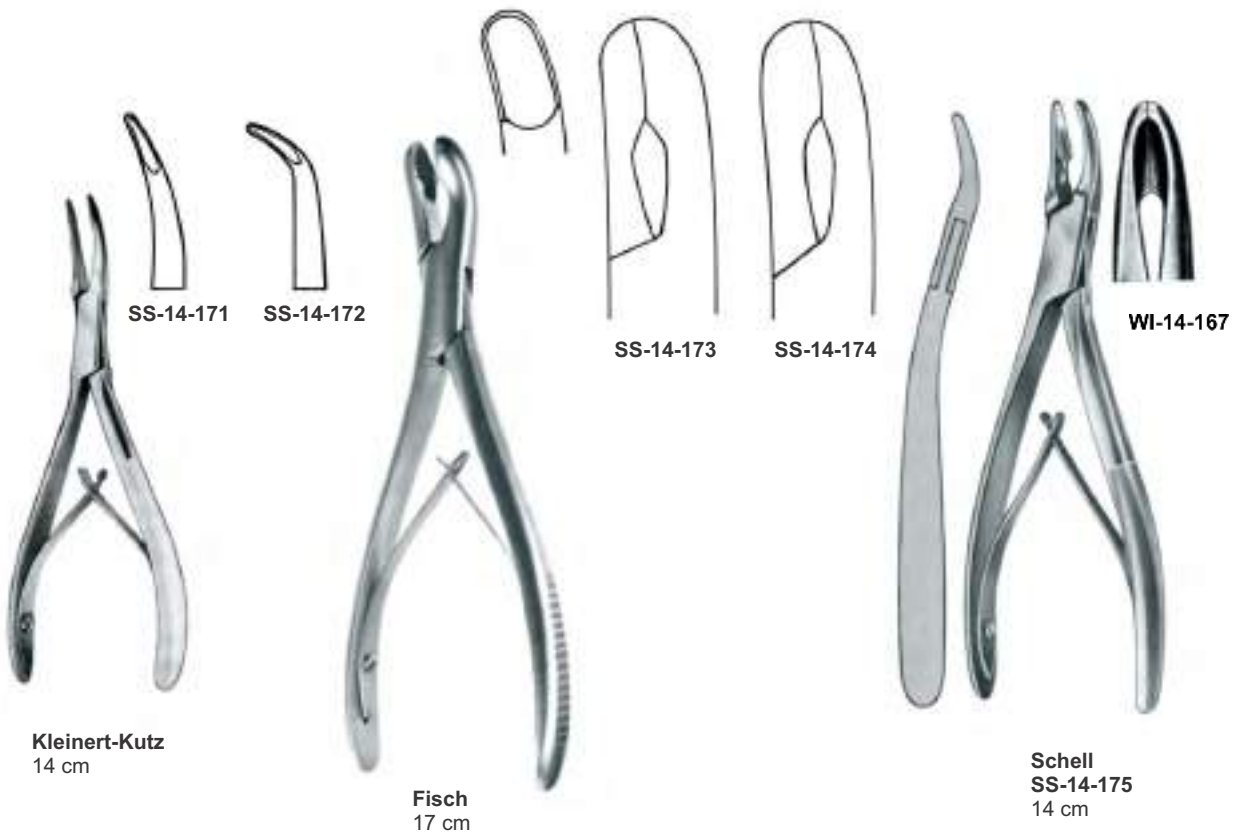

Kleinert-Kutz
14 cm

Fisch
17 cm

Schell
SS-14-175
14 cm

Bone Rongeurs
Pinzas-gubias
Pinces-gouges

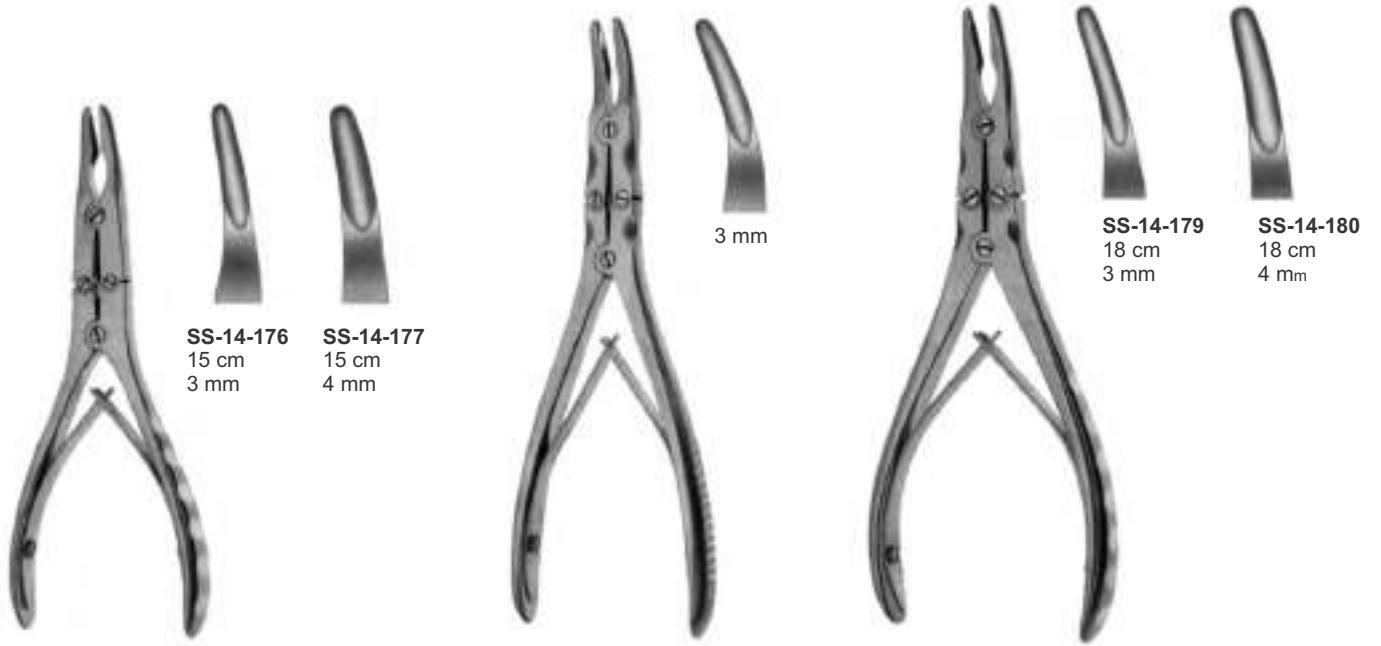

SS-14-176
15 cm
3 mm

SS-14-177
15 cm
4 mm

3 mm

SS-14-179
18 cm
3 mm

SS-14-180
18 cm
4 mm

Bohler

Mayfield
SS-14-178
17.5 cm

Beyer

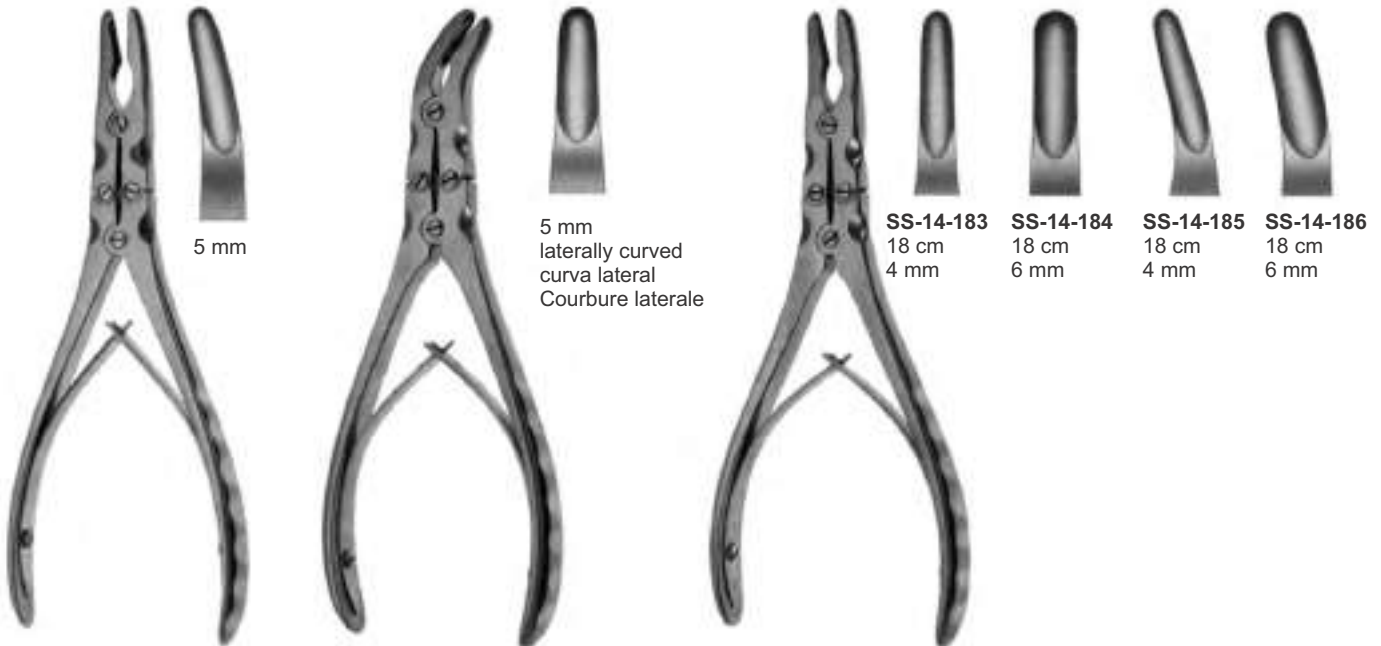

5 mm

5 mm
laterally curved
curva lateral
Courbure laterale

SS-14-183
18 cm
4 mm

SS-14-184
18 cm
6 mm

SS-14-185
18 cm
4 mm

SS-14-186
18 cm
6 mm

Zaufal-Jansen
SS-14-181
18 cm

Ruskin
SS-14-182
18 cm

Ruskin

Bone Rongeurs
Pinzas-gubias
Pinces-gouges



Marquardt
SS-14-187
20 cm

3 mm



Ruskin



SS-14-188
20.5 cm
6 mm



SS-14-189
20.5 cm
6 mm



Luer-Stille

SS-14-190
22 cm
17 mm



SS-14-191
22 cm
17 mm



Echlin



SS-14-192
23 cm
2 x 10 mm



SS-14-193
23 cm
3 x 10 mm



SS-14-194
23 cm
4 x 10 mm

Laterally curved
Curvas lateral
courbure laterale

Bone Rongeurs
 Pinzas-gubias
 Pincers-gouges

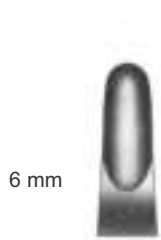

6 mm



3 mm

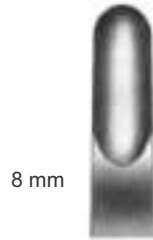

8 mm

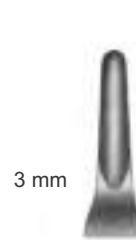

3 mm

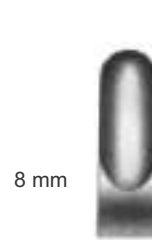

8 mm

SS-14-196
24.5 cm

SS-14-197
24.5 cm

SS-14-198
24 cm

SS-14-199
24 cm



Stille
SS-14-195
 23 cm
 Laterally curved
 curvas lateral
 courbure laterale



Leksell-Stille

 Laterally curved
 curvas lateral
 courbure laterale



Frykholm

 Laterally curved
 curvas lateral
 courbure laterale

Bone Rongeurs
Pinzas-gubias
Pinces-gouges



8 mm

SS-14-200A
Curved



5 mm

SS-14-201A
Curved

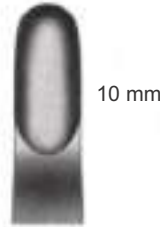

10 mm

SS-14-202
25 cm



10 mm

SS-14-203
25 cm

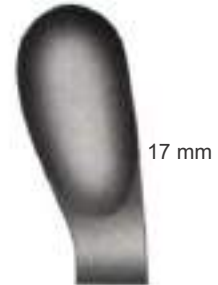

17 mm

SS-14-204A
Curved



Stille-Ruskin
SS-14-200
23.5 cm
Straight



Rottgen-Ruskin
SS-14-201
24 cm
Straight



Luer-Stille



Luer-Stille
SS-14-204
27 cm
Straight

Bone Rongeurs
 Pinzas-gubias
 Pincès-gouges



Smith-Peterson
SS-14-205
 3 mm, 24 cm



Smith-Peterson
SS-14-206
 3 mm, 24 cm



Smith-Peterson
SS-14-207
 3 mm, 24 cm



Leksell
 23 cm



SS-14-208
 5 mm



SS-14-209
 8 mm



Leksell
 23 cm



SS-14-210
 5 mm



SS-14-211
 8 mm

Bone Rongeurs
Pinzas-gubias
Pinces-gouges

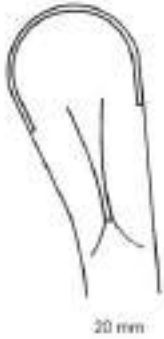

Semb
SS-14-212 23 cm SS-14-214
SS-14-213 27 cm SS-14-215
Straight Curved



Stille-Luer
SS-14-216
27 cm



Peiper-Beyer
SS-14-217
18 cm

Bone Rongeurs
 Pinzas-gubias
 Pincès-gouges

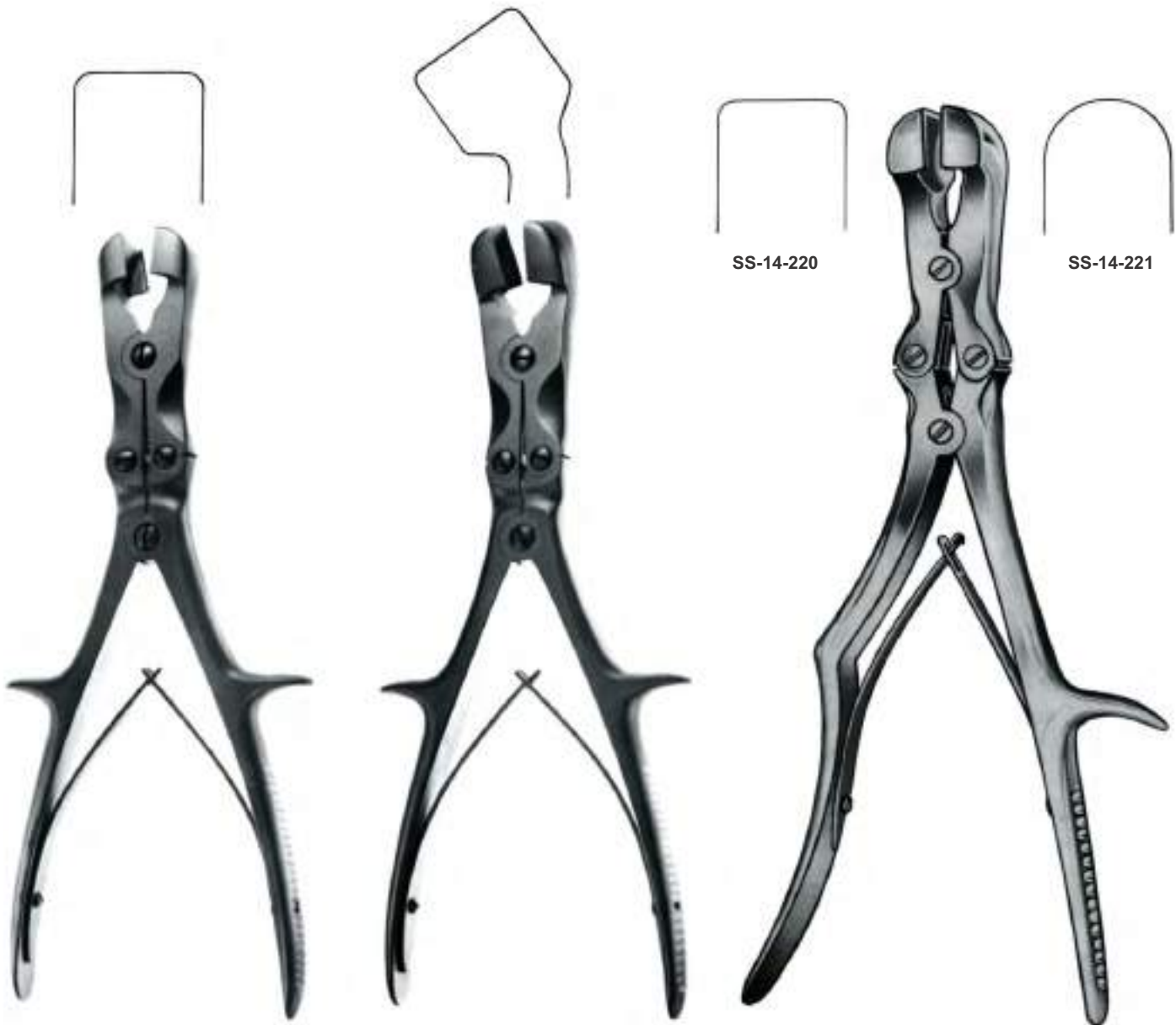

Sauerbruch-Stille
 SS-14-218
 26 cm

Sauerbruch-Stille
 SS-14-219
 26 cm

Sauerbruch-Coryllos
 30 cm

Bone Cutting Forceps
 Pinzas cortantes para huesos
 Pinces coupantes



Littauer-Liston
SS-14-222
 15.5 cm



Kazanjin
SS-14-223
 18.5 cm



Cleveland
SS-14-224
 15 cm



Cleveland
SS-14-225
 17 cm



Liston



SS-14-226
 14 cm

SS-14-227
 17 cm



SS-14-230
 14 cm

SS-14-231
 17 cm



SS-14-228
 19.5 cm

SS-14-229
 22 cm



Liston



SS-14-232
 19.5 cm

SS-14-233
 22 cm

Bone Cutting Forceps
 Pinzas cortantes para huesos
 Pinces coupantes



Walton-Liston (Bohler)
SS-14-234
 14.5 cm



Walton-Liston (Bohler)
SS-14-235
 14.5 cm



Mc Indoe
SS-14-236
 17.5 cm



Ruskin
SS-14-237
 18 cm



Ruskin
SS-14-238
 18 cm



Ruskin-Liston
SS-14-239
 18.5 cm



Ruskin-Liston
SS-14-240
 18.5 cm

Bone Cutting Forceps
Pinzas cortantes para huesos
Pinces coupantes



Liston
SS-14-241
24 cm



Liston
SS-14-242
27 cm



Liston
SS-14-243
27 cm

Bone Cutting Forceps
 Pinzas cortantes para huesos
 Pinces coupantes

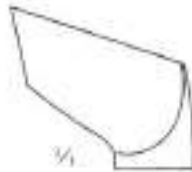
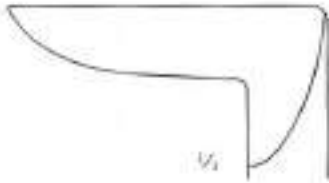

Stille-Liston
SS-14-244
 26 cm / 10 1/4"



Listen-Key
SS-14-245
 25.5 cm / 10"



Semb
SS-14-246
 24.5 cm / 9 3/4"

Meniscus & Cartilage Grasping Forceps
Pinzas para menisco y cartilage
Pincas a menisque et cartilage



Martin
SS-14-247
16.5 cm



Martin
SS-14-248
18.5 cm



Martin
SS-14-249
20.5 cm



Bircher-Ganske
SS-14-250
20.5 cm



Bircher-Ganske
SS-14-251
20.5 cm



Bircher-Ganske
SS-14-252
20.5 cm

Retractors
Separadores
Ecarteurs

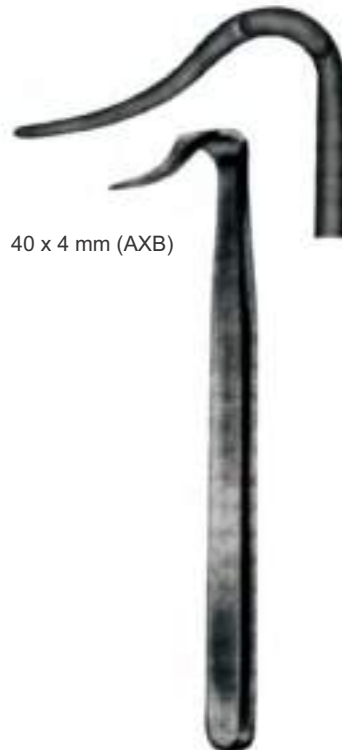
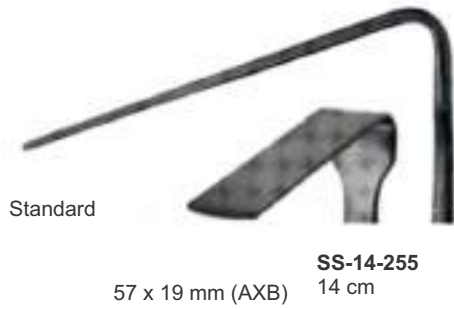

Smillie

Blount
SS-14-259
17 cm

SS-14-260
21 cm



SAPTESTAR
Manufacturer & Exporter Of Surgical, Dental & Veterinary Instruments

Meniscus Knives
Bisturies para menisco
Bistouris a menisque



SS-14-261
17.5 cm



Neff
SS-14-262
20.5 cm



Neff
SS-14-263
20.5 cm



Salenius
SS-14-264
22 cm



Salenius
SS-14-265
22 cm



Meniscus Knives
 Bisturies para menisco
 Bistouris a menisque



Smillie
SS-14-266
 17 cm



Smillie
SS-14-267
 17 cm



Smillie
SS-14-268
 17 cm



Canad-Modell
SS-14-269
 20.5 cm



Canad-Modell
SS-14-270
 20.5 cm



Bircher
SS-14-271
 19 cm



Bircher
SS-14-272
 19 cm

Finger Nail Instruments Finger Ring Saw,
 Sierras para abrir anillos, Instrumentos para unas
 Scies pour bagues, Instruments a ongles



Spare saw blade
 Hoja de repuesto
 Lame de scie de rechange

SS-14-273
16 cm
 Finger ring saw
 Sierra para abrir anillos
 Scie pour bagues



Spare saw blade
 Hoja de repuesto
 Lame de scie de rechange

SS-14-274
16.5 cm
 Finger ring saw
 Sierra para abrir anillos
 Scie pour bagues



SS-14-275
13 cm
 Nail splitting forceps
 Pinzas corta-unas
 Pince a ongles



Radolf
SS-14-276
13.5 cm
 Nail extracting forceps
 Pinzas arranca-unas
 Pince pour extraction des ongles

Tendon Seizing Forceps
 Pinzas para agarrar el tendón
 Pinces a saisir les tendons



SS-14-277
 11.5 cm



Jackson
SS-14-278
 15.5 cm
 4 x 5 teeth
 4 x 5 dientes
 4 x 5 dent



Steinmann
SS-14-279
 15.5 cm

Tendon Holding Forceps
Pinzas-conductoras de tendon
Conducteurs a tendons



Brand



SS-14-280
15 cm



SS-14-281
19 cm



SS-14-282
24 cm



Brand



SS-14-283
15 cm



SS-14-284
19 cm



SS-14-285
24 cm

Tendon Interlacing Forceps
Pinzas para entrelazar tendons
Pinces pour entrelacer les tendons



SS-14-286
21 cm / 8 ¼"



1:2

SS-14-287
21 cm / 8 ¼"



1:2



Carroll
SS-14-288
11.5 cm / 4 ½"



SS-14-289
15 cm
Tendon Interlacing Forceps
Pinzas para entrelazar tendon
Pinces pour entrelacer les tendons



SS-14-290
15 cm
Tendon Interlacing Forceps
Pinzas para entrelazar tendon
Pinces pour entrelacer les tendons

Hand Drills
Perforadores de mano
Perforateurs a main



Complete with three twist drills ref.
Completo con tres brocas ref.
Complet avec trois fraises ref.
SS-14-262 - SS-14-264

Stille-Sherman
SS-14-291
24 cm



Complete with nine twist drills ref.
Completo con nueve brocas ref.
Complet avec neuf fraises ref.
SS-14-262 - SS-14-270

Stille
SS-14-292
20.5 cm



SS-14-293
2.5 mm \emptyset
Twist Drill
Broca espiral
Meche helicoidale



SS-14-294
3 mm \emptyset
Twist Drill
Broca espiral
Meche helicoidale



SS-14-295
3.5 mm \emptyset
Twist Drill
Broca espiral
Meche helicoidale



SS-14-296
4 mm \emptyset
Twist Drill
Broca espiral
Meche helicoidale



SS-14-297
10 mm \emptyset
Trephine
Trepano
Trepan



SS-14-298
5 mm \emptyset
Spherical Burr
Fresa esferica
Fraise spherique



SS-14-299
8 mm \emptyset
Spherical Burr
Fresa esferica
Fraise spherique



SS-14-300
12 mm \emptyset
Spherical Burr
Fresa esferica
Fraise spherique



SS-14-301
16 mm \emptyset
Spherical Burr
Fresa esferica
Fraise spherique



SS-14-302
1 mm \emptyset
Twist Drill
Broca espiral
Meche helicoidale



SS-14-303
1.5 mm \emptyset
Twist Drill
Broca espiral
Meche helicoidale



SS-14-304
2 mm \emptyset
Twist Drill
Broca espiral
Meche helicoidale

Hand Drills
Perforadores de mano
Perforateurs a main



SS-14-314
Fig. 9
Extension piece
Pieza de prolongacion
Piece de rallonge

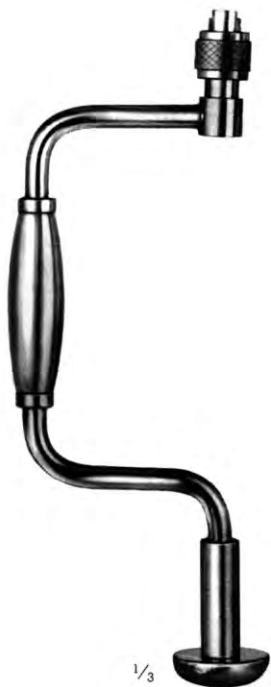

1/3

Hudson
SS-14-305
28 cm



SS-14-306
Fig. 1
Conical Burr
Fresa conica
Fraise conique



SS-14-307
Fig. 2
Conical Burr
Fresa conica
Fraise conique



SS-14-308
Fig. 3
Spherical Burr
Fresa esferica
Fraise spherique



SS-14-309
Fig. 4
Spherical Burr
Fresa esferica
Fraise spherique



SS-14-310
Fig. 5
Flat Trepine
Taladro plano
Fraise plate



SS-14-311
Fig. 6
Twist Drill
Broca espiral
Meche helicoidale



SS-14-312
Fig. 7
Burr
Fresa
Fraise



SS-14-313
Fig. 8
Burr
Fresa
Fraise

Complete, with burrs number 1-4 and extension piece
completo, con fresas number 1-4 y pieza de extension
complet, avec fraises no 1-4 et piece de rallonge



SAPTESTAR
Manufacturer & Exporter Of Surgical, Dental & Veterinary Instruments

Hand Drills
Perforadores de mano
Perforateurs a main



SS-14-316
Twist Drill
Broca espiral
Meche helicoidale

Set of 3
juego de 3
jue de 3

2x = 70 x 3.2 mm
1x = 90 x 3.2 mm



SS-14-318
Wrench
Llave
Cle'



SS-14-315



SS-14-317



Jacobs
SS-14-319
6.35 mm
Mandril de sujecion
Mandrin a trois
Machoirs

With borchardt shaft
con vastago borchardt
avec tige brochartd

Max. Opening
abertura max
pour montage de tiges jusqu'a

Complete with a set of twist drills ref. SS-14-287
Completo con un juego de brocas ref. SS-14-287
Complet avec un jeu de fraises ref, SS-14-287

Wire Twisting Forceps with tungsten carbide edges
Pinzas cierra-hilos con filos de carbure tungsteno
Pincers serre-fils avec des lames en tungstene



SS-14-320
15.5 cm



SS-14-321
18 cm



SS-14-322
15.5 cm



SS-14-323
18 cm



SS-14-324
15.5 cm



SS-14-325
20 cm



SAPTESTAR
Manufacturer & Exporter Of Surgical, Dental & Veterinary Instruments

Wire Twisting Forceps with tungsten carbide edges
Pinzas cierra-hilos con filos de carbure tungsteno
Pincas serre-fils avec des lames en tungstene



SS-14-326
19 cm
Heavy pattern
modelo fuerte
Modele fort



SS-14-327
15.5 cm



SS-14-328
18.5 cm

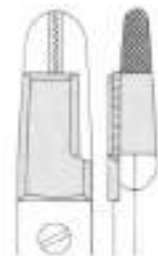

SS-14-329
18.5 cm
Regular



Martin
Combi-Wire Twisting Forceps
Combi-Pinza de alambre
Combi-Pince a torsader le fil

Koppelmann-Leibinger



TC - H/Gold



SS-14-330
 20 cm / 8"



SS-14-331
 15 cm
 for bending and cutting
 para cortar y doblar
 pour plier et couper



SS-14-332
 13.5 cm
 Modelling pliers



SS-14-333
 13.5 cm
 Modelling pliers



SS-14-334
 12.5 cm
 bending pliers



SS-14-335
 18 cm
 plate cutter



SAPTESTAR
Manufacturer & Exporter Of Surgical, Dental & Veterinary Instruments

Combi-Flat Nose Pliers, Fla Nose Pliers
Combi-Alicates de alambre, Alicates de pico plano
Combi-Pinces pour fils, Pinces plates

2 mm

3 mm

5 mm

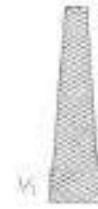

SS-14-336
18 cm

SS-14-337
18 cm

SS-14-338
18 cm

SS-14-339
13.5 cm
3 mm

Plier with 2 mm delicate tip can be
Used to remove up to 1.6 mm k-wires
From hard-to-reach areas

Plier with 3 mm and 5 mm jaws
Can be used to grasp all sizes
For wires and pins

Parallel grip
accion paralela
action parallele

TC-H/Gold



2 mm

4 mm

8 mm



SS-14-340
18 cm

SS-14-341
18 cm

SS-14-342
18 cm

SS-14-343
18 cm
3 mm

Parallel grip
accion paralela
action parallele



Flate Nose Pliers
Alicates de pico plano
Pinces plates



SS-14-344
18.5 cm
accion paralela
action parallele
afferramento parallelo
rostfrei
stainless steel
acero inoxidable



SS-14-345
20.5 cm
stainless steel
acero inoxidable
acier inoxydable



SS-14-346
16 cm
With longitudinal groove
con ranura longitudinal
avec rainure longitudinale

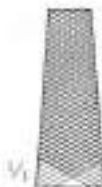

SS-14-347
17.5 cm



SS-14-348
17 cm
With crosswise groove
Con ranura en forma de cruz
avec rainures croisees



SS-14-349
19.5 cm

Hackstock

Flate Nose Pliers, Pointed
Alicates planos/agudos
Pinces plates/aigues

Wire Cutting Pliers
Cizallas corta-alambres
Pinces coupe-fils



SS-14-350
18.5 cm

2.4 mm \emptyset
For soft wires up to
para alambres blandos hasta
pour fils mous jusqu'a'

1.8 mm \emptyset
for hard wires up to
para alambres duros hasta
pour fils durs jusqu'a'



Martin "Diamant"
SS-14-351
16 cm

2.2 mm \emptyset
For soft wires up to
para alambres blandos hasta
pur fils mous jusqu'a'

2.0 mm \emptyset
for hard wires up to
para alambres duros hasta
pour fils durs jusqu'a'

Wire cutter, front action
Alicate frontal para cortar alambre
Pinces coupantes frontales

Wire Cutting Pliers with tungsten carbide edge
Cizallas corta-alambres con filos de carbure tungsteno
Pincas coupe-fils avec des lames en tungstene



2.0 mm \emptyset
For soft wires up to
para alambres blandos hasta
pour fils mouss jusqu'a'

1.7 mm \emptyset
for hard wires up to
para alambres duros hasta
pour fils durs jusqu'a'

SS-14-354
17 cm



2.8 mm \emptyset
For soft wires up to
para alambres blandos hasta
pour fils mouss jusqu'a'

2.2 mm \emptyset
for hard wires up to
para alambres duros hasta
pour fils durs jusqu'a'

SS-14-355
22.5 cm



2.0 mm \emptyset
For soft wires up to
para alambres blandos hasta
pour fils mous jusqu'a'

1.2 mm \emptyset
for hard wires up to
para alambres duros hasta
pour fils durs jusqu'a'

SS-14-356
15 cm



2.0 mm \emptyset
For soft wires up to
para alambres blandos hasta
pour fils mous jusqu'a'

1.5 mm \emptyset
for hard wires up to
para alambres duros hasta
pour fils durs jusqu'a'

SS-14-357
17.5 cm

Wire cutting plier
Alicate para cortar alambre
Pincas pour couper le fil



SAPTESTAR
Manufacturer & Exporter Of Surgical, Dental & Veterinary Instruments

Wire Tightener Wire Guides,
Agujas pasa-hilo, Tensor cierra-hilo
Aiguilles passe-fils, Tendeur serre-fil



Demel

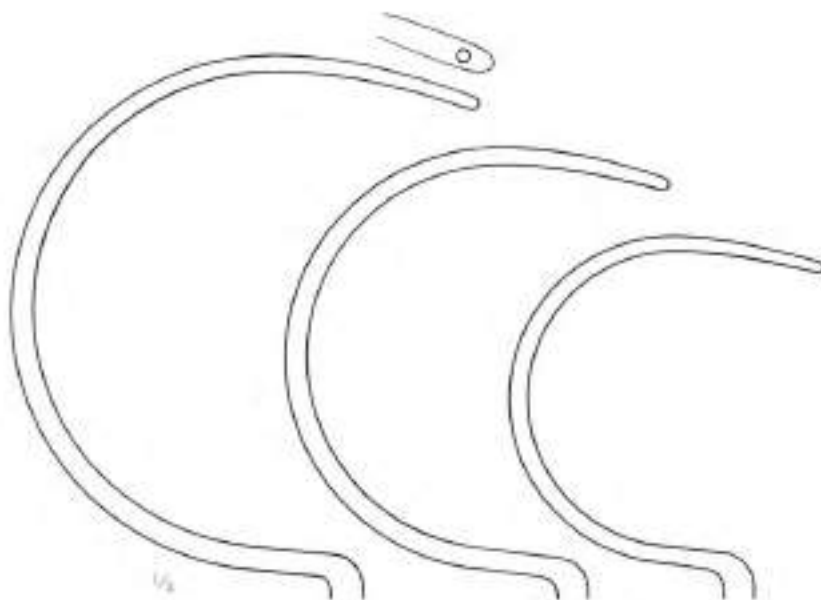

SS-14-358
Fig. 1
31 cm

SS-14-359
Fig. 2
29 cm

SS-14-360
Fig. 3
28 cm



Loute
SS-14-361
21 cm

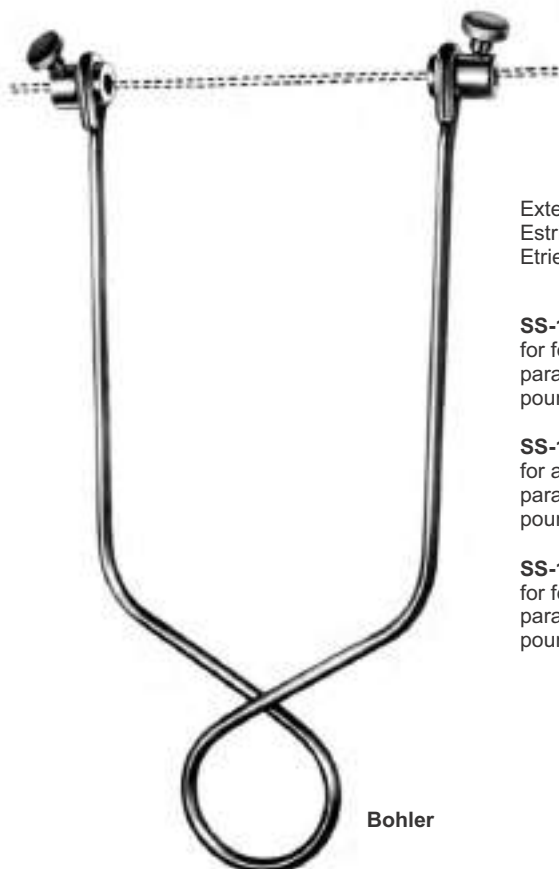

Bohler

Extension Bows
Estribos para extension
Etriers a extension

SS-14-362 210 x 150 mm
for femur & knee
para femuy y rodilla
pour femur et genou

SS-14-363 160 x 90 mm
for arm
para brazo
pour bras

SS-14-364 210 x 110 mm
for femur & knee
para femuy y rodilla
pour femur et genou

Extension Bows
Estribos para extension
Etriers a extension



Krischner
with 3 traction hook
con 3 ganchos de traccion
avec 3 crochets de traction

SS-14-370
18.5 cm
small pattern
modelo pequeno
modele petit
SS-14-371
26.5 cm
large pattern
modelo largo
modele grand



SAPTESTAR
Manufacturer & Exporter Of Surgical, Dental & Veterinary Instruments

Extension Bows
Estribos para extension
Etriers a extension



Inner width
vano
largeur ouverte

SS-14-372 180 x 100 mm

SS-14-373 270 x 160 mm



Demel
SS-14-374
270 mm, 10³/₄"
Drahtspannzange
Wire tightening and twisting forceps



SS-14-375
23 cm / 9"

SS-14-376
25 cm / 9³/₄"
soft wire 2.3 mm
hard wire 1.7 mm



SS-14-377
 24 cm

Head cabeza tete	Weight peso poids
26 mm ø	300 gr.

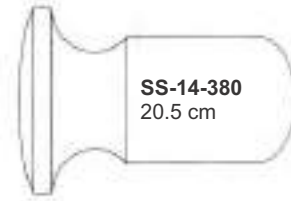

SS-14-380
 20.5 cm

Head cabeza tete	Weight peso poids
25 mm ø	120 gr.



SS-14-378
 24 cm

Head cabeza tete	Weight peso poids
28 mm ø	340 gr.



SS-14-381
 21 cm

Head cabeza tete	Weight peso poids
30 mm ø	180 gr.



SS-14-379
 24 cm

Head cabeza tete	Weight peso poids
30 mm ø	400 gr.



SS-14-382
 21.5 cm

Head cabeza tete	Weight peso poids
35 mm ø	260 gr.



Williger
 lead fillet
 relleno de plomo



Doyen



30 mm \varnothing
Head
cabeza
tete

220 gr.
Weight
peso
poids

Collin
SS-14-383
20 cm



SS-14-384

19 mm \varnothing	230 gr.
Head	Weight
cabeza	peso
tete	poids



SS-14-385

25 mm \varnothing	260 gr.
Head	Weight
cabeza	peso
tete	poids

Lucae



30 mm \varnothing
Head
cabeza
tete

300 gr.
Weight
peso
poids

Cottle
SS-14-386
19 cm
plan / konvex
plane / convex
plano / convexo
plan / convexe
plano / convesso

Mallets
Martillos
Maillets



SS-14-390
Spare facing (pair)
Tapas de repuesto (par)
Plaques de rechange (paire)

Plastic
Plastico
Matiere plastique



20 mm \varnothing
Head
cabeza
tete

140 gr.
Weight
peso
poids

Williger
SS-14-387
16.5 cm



30 mm \varnothing
Head
cabeza
tete

510 gr.
Weight
peso
poids

SS-14-388
26 cm
Plastic handle
mango de plastico
manche en matiere plastique



27 mm \varnothing
Head
cabeza
tete

320 gr.
Weight
peso
poids

Mead
SS-14-389
19 cm
with interchangeable plastic disks
con tapas intercambiables
avec plaques interchangeables



22 mm \varnothing
Head
cabeza
tete

200 gr.
Weight
peso
poids

Partsch
SS-14-391
19 cm
with hollow handle
con mango hueco
avec manche creux

Mallets
Martillos
Maillets



42 mmØ
Head
cabeza
tete

400 gr.
Weight
peso
poids

SS-14-392
26 cm
made of plastic
with lead filling
de plastico con
relleno de plomo
en matiere plastique
remplissage de plomb



42 mmØ
Head
cabeza
tete

250 gr.
Weight
peso
poids

SS-14-393
26 cm
made of plastic
without lead
de plastico con
sin plomo
en matiere plastique
sans plomb



42 mmØ
Head
cabeza
tete

400 gr.
Weight
peso
poids

SS-14-394
26 cm
made of plastic
with lead filling
de plastico con
relleno de plomo
en matiere plastique
remplissage de plomb

30 mmØ
Head
cabeza
tete

675 gr.
Weight
peso
poids

SS-14-395
26.5 cm
plane (nylon) / convex (steel)
plastic handle
plano (nilon) / convexo (acero)
mango de plastico
plan (Nylon) / convexe (acier)
manche en matiere plastique

Mallets
Martillos
Maillets



SS-14-399
Spare Facing (pair) Plastic
Tapas de repuesto (par) plastico
Plaques de rechange (paire) matiere plastique



42 / 30 mm ø
head
cabeza
tete

530 gr.
Weight
peso
poids

SS-14-396
26 cm
Plastic handle
mango de plastico
Manche en matiere plastique



30 mm ø
head
cabeza
tete

480 gr.
Weight
peso
poids

SS-14-397
24 cm
Plastic handle
mango de plastico
Manche en matiere plastique

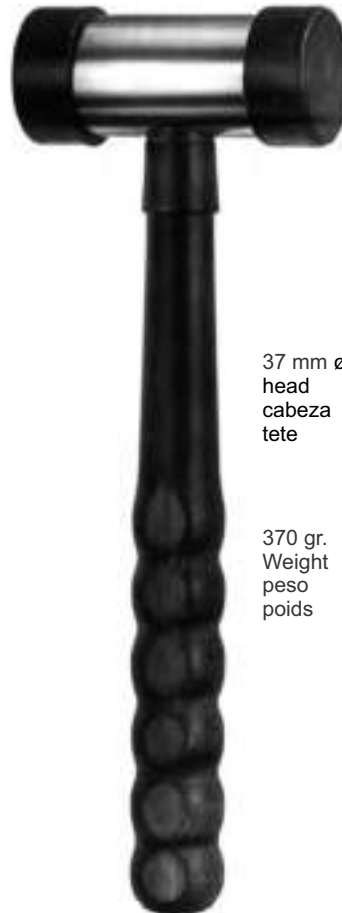

37 mm ø
head
cabeza
tete

370 gr.
Weight
peso
poids

SS-14-398
24 cm
disks and handle of plastic
mango y tapas de plastico
manche et plaques en matiere plastique



30 mm ø
head
cabeza
tete

125 gr.
Weight
peso
poids

SS-14-400
22 cm
made of of plastic
de plastico
en matiere plastique

Mallets
Martillos
Maillets



30 mm \varnothing
head
cabeza
tete

450 gr.
Weight
peso
poids

SS-14-401
26.5 cm
plastic handle
mango de plastico
manche en matiere plastique



50 mm \varnothing
head
cabeza
tete

900 gr.
Weight
peso
poids

SS-14-402
26.5 cm
plastic handle
mango de plastico
manche en matiere plastique



25 mm \varnothing
head
cabeza
tete

300 gr.
Weight
peso
poids

Vickers
SS-14-403
19 cm
nylon disks plastic handle
tapas de nilon mango de plastico
plaque en nylon manche en
matiere plastique

Bone Currettes
Cucharillas cortantes
Curettes



House
SS-14-404
15.5 cm



House
SS-14-405
15 cm



Martini
14 cm



SS-14-406

SS-14-407

SS-14-408



Williger
14 cm



SS-14-409

SS-14-410

SS-14-411

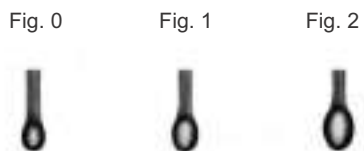

Williger
16 cm



SS-14-412

SS-14-413

SS-14-414



Bone Crettes
Cucharillas cortantes
Curettes

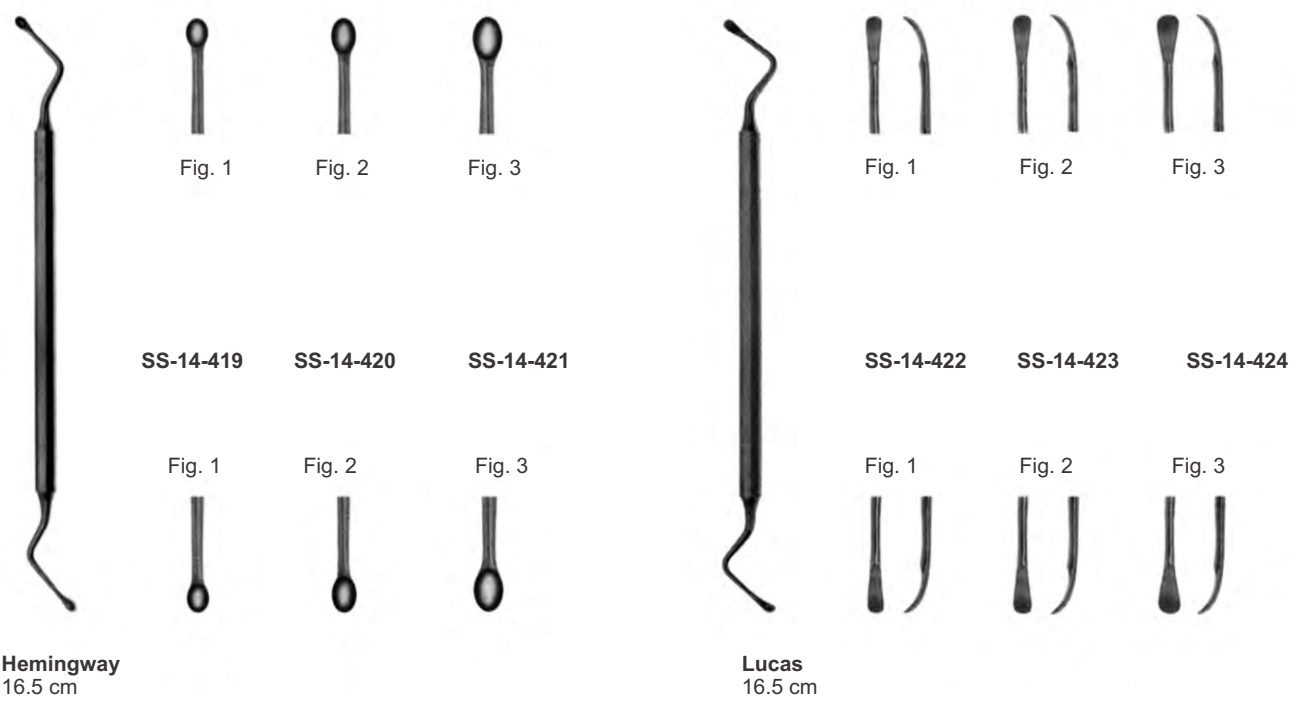
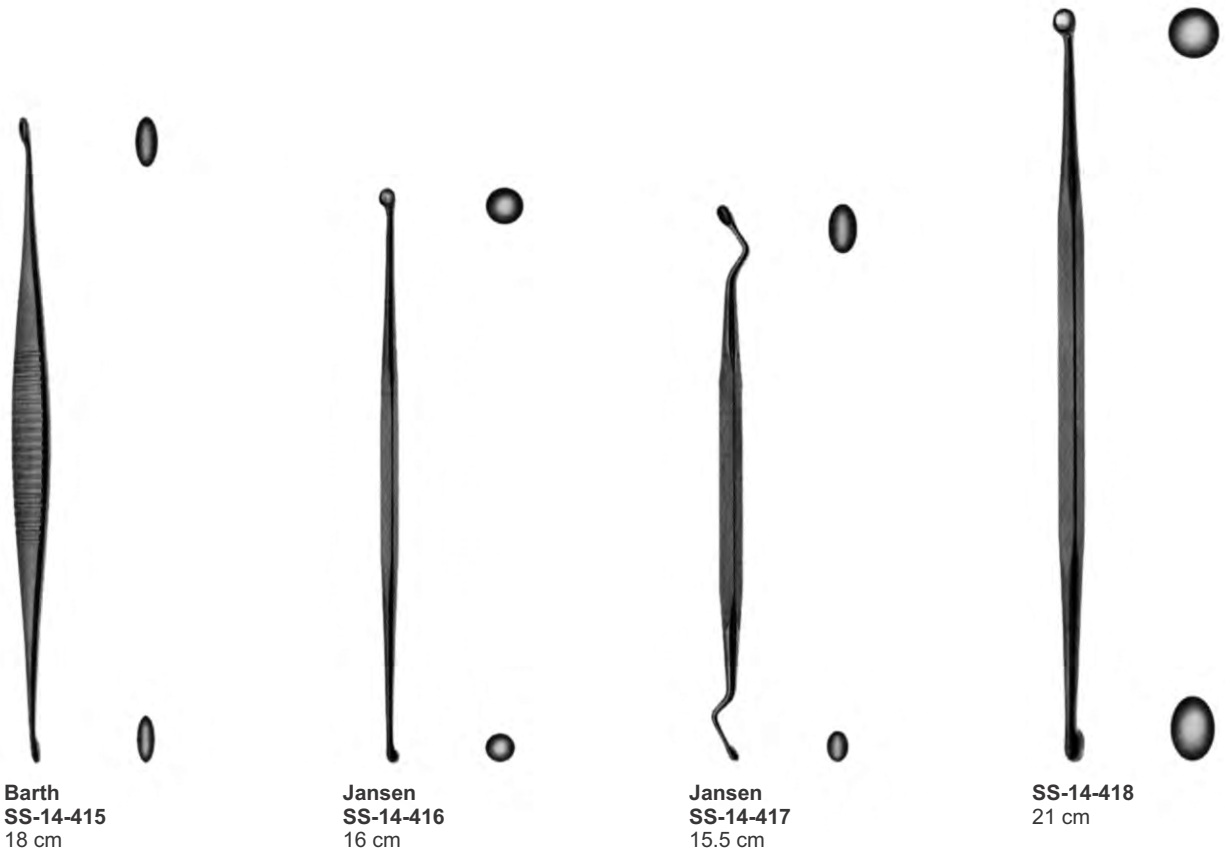

Bone Crettes
Cucharillas cortantes
Crettes



Volkman
SS-14-425
12.5 cm



Volkman
SS-14-426
16.5 cm



Volkman
SS-14-427
20.5 cm



Volkman
SS-14-428
13 cm



Volkman
SS-14-429
16.5 cm



Volkman
SS-14-430
20 cm



Williger
17.5 cm

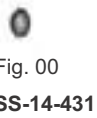

Fig. 00
SS-14-431



Fig. 0
SS-14-432



Fig. 00
SS-14-435



Fig. 0
SS-14-436



Fig. 1
SS-14-433



Fig. 2
SS-14-434



Fig. 1
SS-14-437



Fig. 2
SS-14-438



Williger
17.5 cm

Bone Crettes
Cucharillas cortantes
Curettes



Uffenerde
SS-14-439
17 cm



Uffenerde
SS-14-440
17 cm



Mod. USA
16 cm

Fig.1
SS-14-441

Fig.2
SS-14-442

Fig.3
SS-14-443

Fig.4
SS-14-444

Fig.5
SS-14-445

Fig.6
SS-14-446



Mod. USA
15.5 cm

Fig.1
SS-14-447

Fig.2
SS-14-448

Fig.3
SS-14-449

Fig.4
SS-14-450

Fig.5
SS-14-451

Fig.6
SS-14-452



Mod. USA
15.5 cm

Fig.1
SS-14-453

Fig.2
SS-14-454

Fig.3
SS-14-455

Fig.4
SS-14-456

Fig.5
SS-14-457

Fig.6
SS-14-458

Bone Currettes
Cucharillas cortantes
Currettes

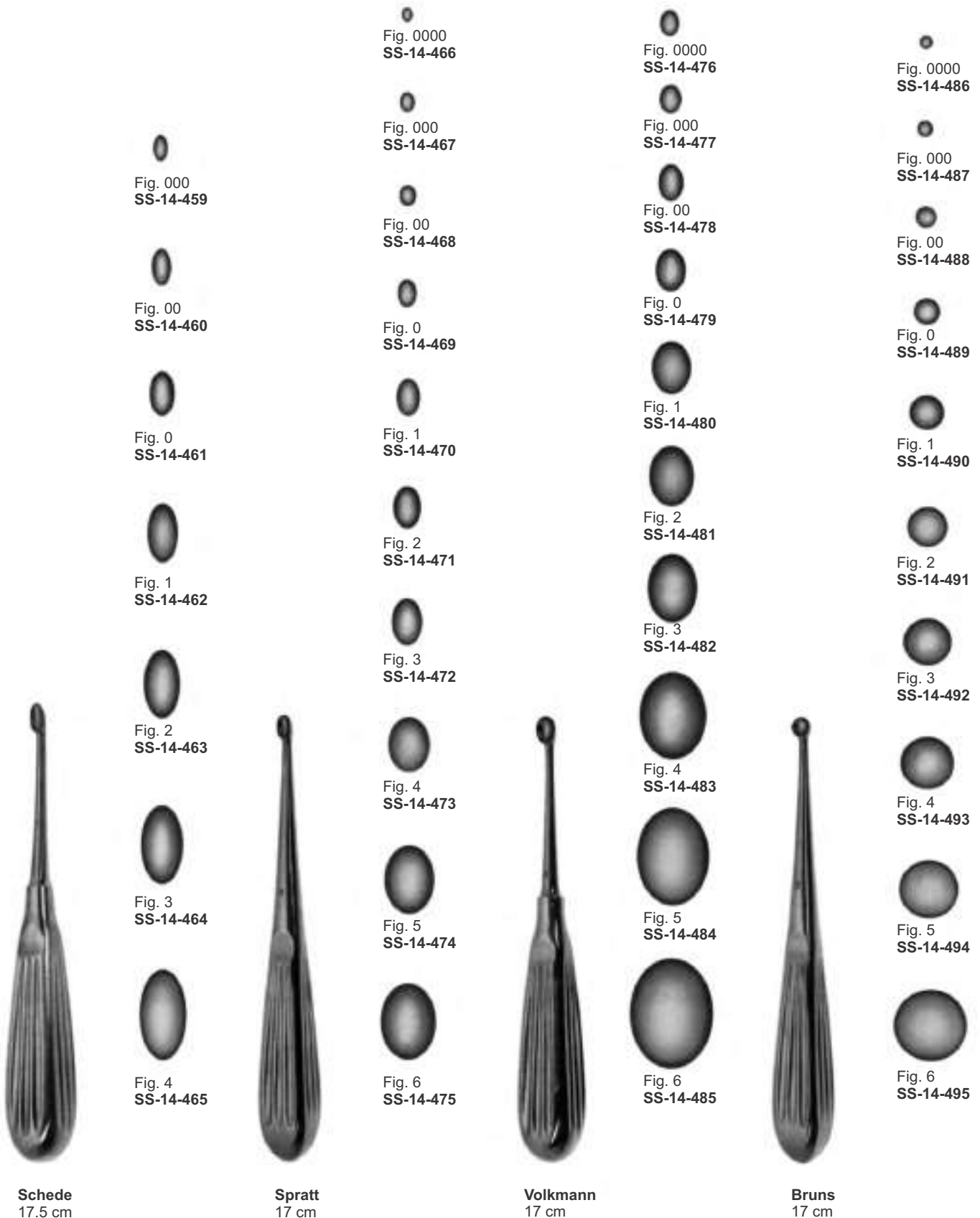



SAPTESTAR
Manufacturer & Exporter Of Surgical, Dental & Veterinary Instruments

Bone Currettes Cucharillas cortantes Currettes



Fig. 000
SS-14-496



Fig. 00
SS-14-497



Fig. 0
SS-14-498



Fig. 1
SS-14-499



Fig. 2
SS-14-500



Fig. 3
SS-14-501



Fig. 4
SS-14-502



Fig. 5
SS-14-503



Fig. 6
SS-14-504



Bruns
23 cm



Fig. 000
SS-14-505



Fig. 00
SS-14-506



Fig. 0
SS-14-507



Fig. 1
SS-14-508



Fig. 2
SS-14-509



Fig. 3
SS-14-510



Fig. 4
SS-14-511



Fig. 5
SS-14-512



Fig. 6
SS-14-513



Bruns
22.5 cm



Fig. 000
SS-14-514



Fig. 00
SS-14-515



Fig. 0
SS-14-516



Fig. 1
SS-14-517



Fig. 2
SS-14-518



Fig. 3
SS-14-519



Fig. 4
SS-14-520



Fig. 5
SS-14-521



Fig. 6
SS-14-522



Bruns
23 cm

Bone Currettes
Cucharillas cortantes
Currettes



Fig. 00000
SS-14-523

Fig. 000
SS-14-525

Fig. 0
SS-14-527

Lempert
20.5 cm

Fig. 0000
SS-14-524

Fig. 00
SS-14-526

Fig. 1
SS-14-528



Malleable
maleable
malleable

Halle
21 cm

Fig. 1
SS-14-529

Fig. 2
SS-14-530

Fig. 3
SS-14-531



Daubenspeck
SS-14-532
19.5 cm



Fig. 000
SS-14-533

Fig. 00
SS-14-534

Fig. 0
SS-14-535

Fig. 1
SS-14-536



Fig. 000
SS-14-537

Fig. 00
SS-14-538

Fig. 0
SS-14-539

Fig. 1
SS-14-540



Fig. 000
SS-14-541

Fig. 00
SS-14-542

Fig. 0
SS-14-543

Fig. 1
SS-14-544

Bone Crettes
Cucharillas cortantes
Curettes

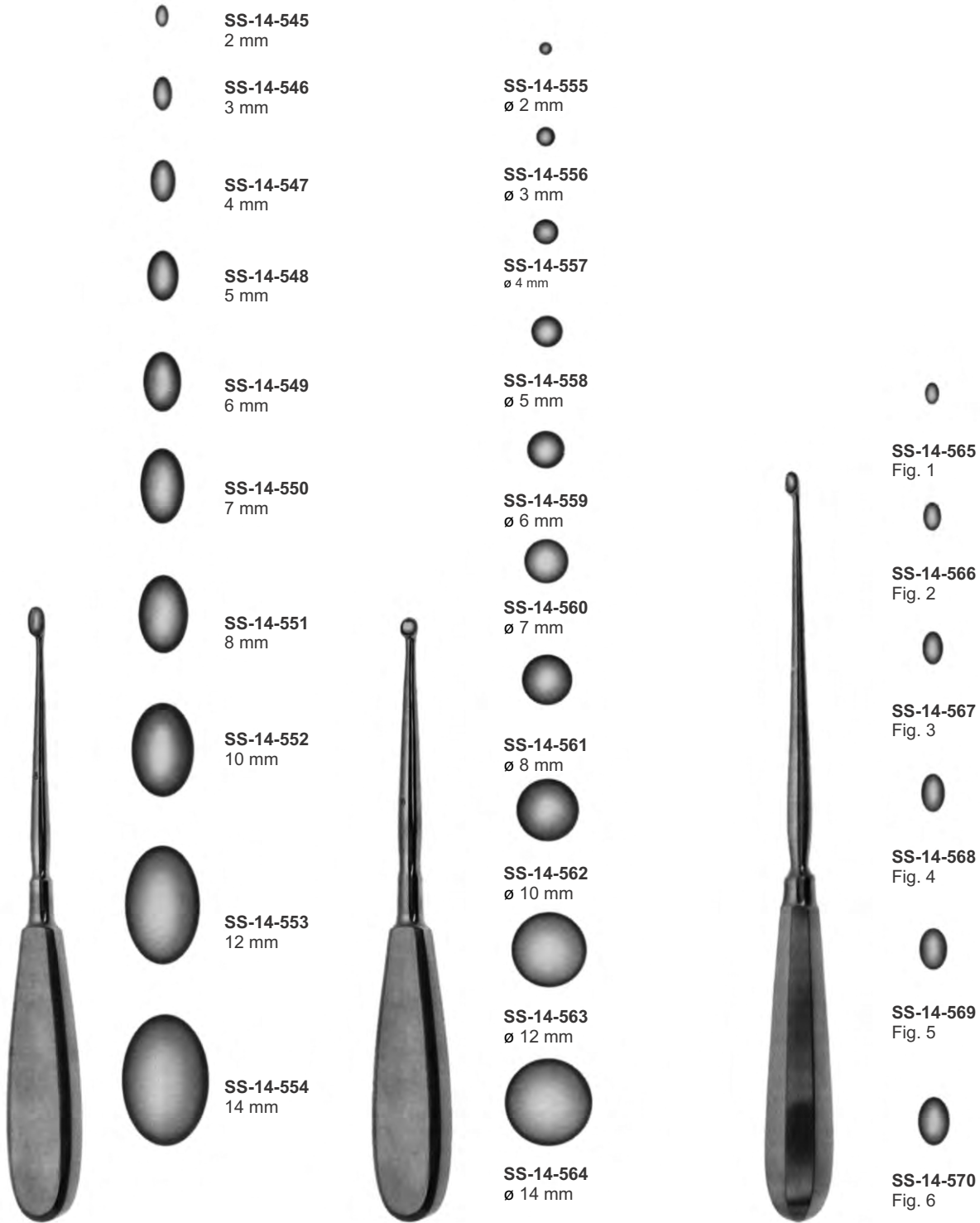

18 - 22 cm
Swedish pattern
modelos sueco
modeles suedois

17 - 20 cm
Swedish pattern
modelos sueco
modeles suedois

Simon
24 cm

Bone Currettes Tampers Cucharillas cortantes Pison Currettes Chasse-Greffons

Fig. 0000
SS-14-571

Fig. 000
SS-14-572

Fig. 00
SS-14-573

Fig. 0
SS-14-574

Fig. 1
SS-14-575

Fig. 2
SS-14-576

Fig. 3
SS-14-577

Fig. 4
SS-14-578

Fig. 5
SS-14-579

Fig. 6
SS-14-580



Volkman
17.5 cm
Bone currettes with handle from artificial wood
Cucharillas cortantes con mango de maderas artificial
Currettes avec manche en "Ferrozell"

Fig. 0000
SS-14-581

Fig. 000
SS-14-582

Fig. 00
SS-14-583

Fig. 0
SS-14-584

Fig. 1
SS-14-585

Fig. 2
SS-14-586

Fig. 3
SS-14-587

Fig. 4
SS-14-588

Fig. 5
SS-14-589

Fig. 6
SS-14-590



Volkman
28 cm
Bone currettes with handle from artificial wood
Cucharillas cortantes con mango de maderas artificial
Currettes avec manche en "Ferrozell"

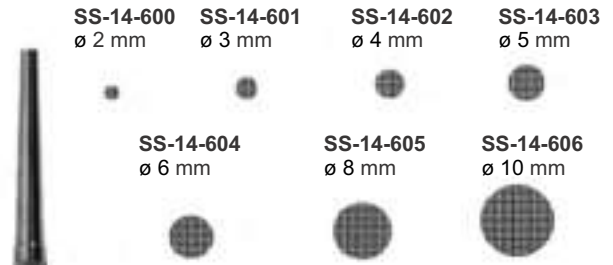

Can be autoclaved at 3 bar overpressure (143°C)
Esterilizables en autoclave a 3 bar sobrepresion (143°)
Sterilisables a l' autoclave a 3 bars (143°C)

16 cm
Tampers
Pison
Chasse-Greffons

SS-14-607
ø 3 mm

SS-14-608
ø 5 mm

SS-14-609
ø 8 mm

SS-14-610
ø 12 mm

SS-14-611
ø 14 mm

SS-14-612
ø 16 mm

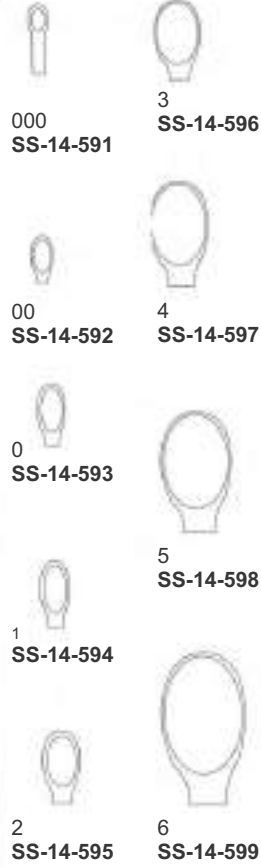

Cobb
28 cm



20 cm
Tampers with handle from artificial wood
Pison con mango de maderas artificial
Chasse-Freffons avec manche en "Ferrozell"

Amputation & Resection Saws
Sierras para amputacion y reseccion
Scies a amputation et reseccion



Langenbeck
SS-14-615
23.5 cm



Charriere
SS-14-616
27 cm



Satterlee
SS-14-617
29 cm
With interchangeable saw blade (SS-14-568)
Con hoja de sierra intercambiable (SS-14-568)
avec lame interchangeable (SS-14-568)



Charrier
SS-14-618

35 cm
with 1 each interchangeable saw blade
12 mm (SS-14-570) and 18 mm (SS-14-571)

Con be hojas de sierras intercambiables
12 mm (SS-14-570) y 18 mm (SS-14-571)

avec 1 jeu de 2 lames de scie 12 mm
(SS-14-570) et 18 mm (SS-14-571)



Bier
SS-14-619

40.5 cm
with 1 each interchangeable saw blade
4 mm (SS-14-573), 6 mm (SS-14-574)
and 8 mm (SS-14-575)

Con 3 hojas de sierras intercambiables
4 mm (SS-14-573), 6 mm (SS-14-574) y 8 mm
(SS-14-575)

avec 1 jeu de 4 lames de scies 4 mm
(SS-14-573), 6 mm (SS-14-574) et 8 mm
(SS-14-575)

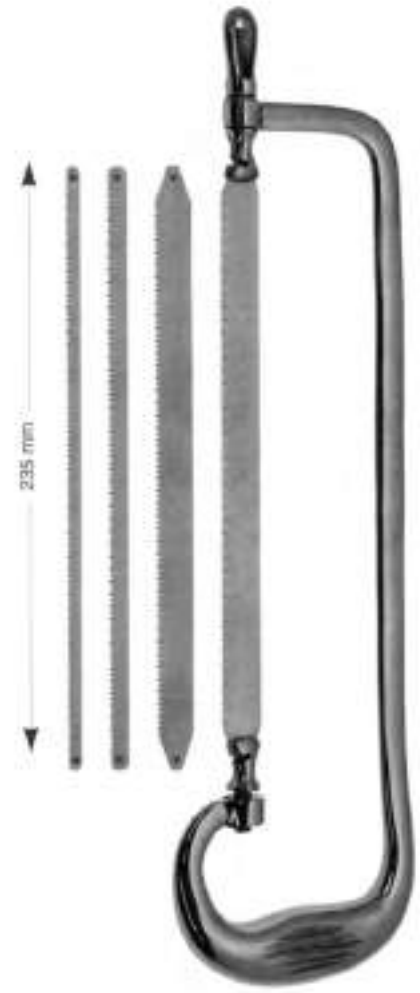

Rust
SS-14-620

39 cm
with 1 each interchangeable saw blade
6 mm (SS-14-578), 15 mm (SS-14-579)
and 18 mm (SS-14-580)

Con 4 hojas de sierras intercambiables
6 mm (SS-14-577), 8 mm (SS-14-578) y
15 mm (SS-14-579) y 18 mm (SS-14-580)

avec 1 jeu de 4 lames de scies 6 mm
(SS-14-577), 8 mm (SS-14-578),
15 mm (SS-14-579) et 18 mm (SS-14-580)



SAPTESTAR
Manufacturer & Exporter Of Surgical, Dental & Veterinary Instruments

Dissectors
Disecadores
Dissecteurs

Elevators
Elevadores
Elevateurs

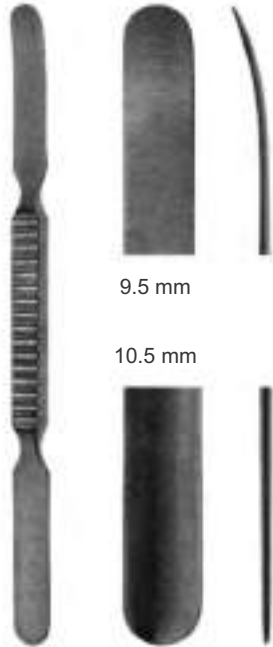

9.5 mm

10.5 mm

Watson-Cheyne
SS-14-621
17.5 cm



5 mm

5 mm

Mc Donald
SS-14-622
19 cm

Dissectors Disecadores Dissecteurs

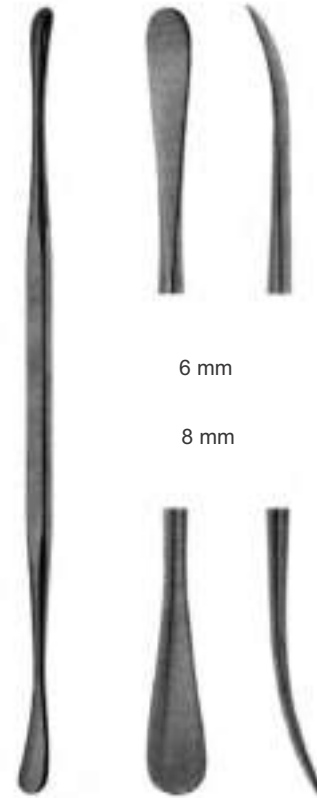

6 mm

8 mm

Alderdyce
SS-14-623
21.5 cm

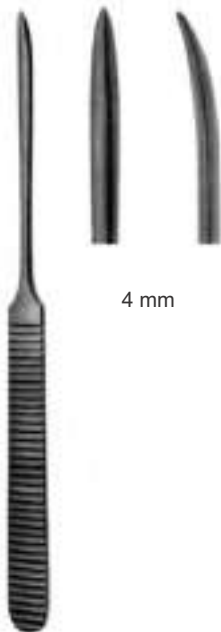

4 mm

Williger
SS-14-624
17 cm

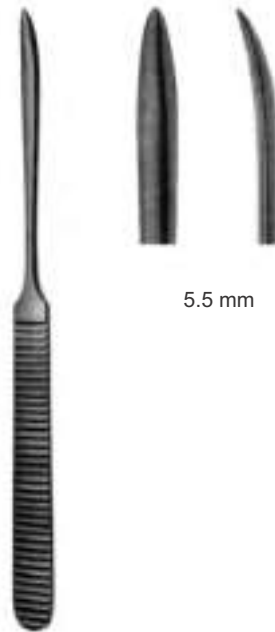

5.5 mm

Williger
SS-14-625
17 cm

Elevators Elevadores Elevateurs



5.5 mm

SS-14-626
16.5 cm

Elevators
 Elevadores
 Elevateurs

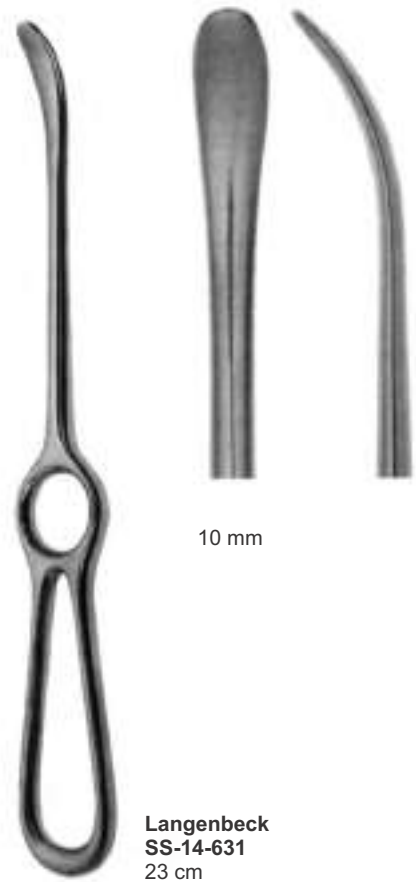
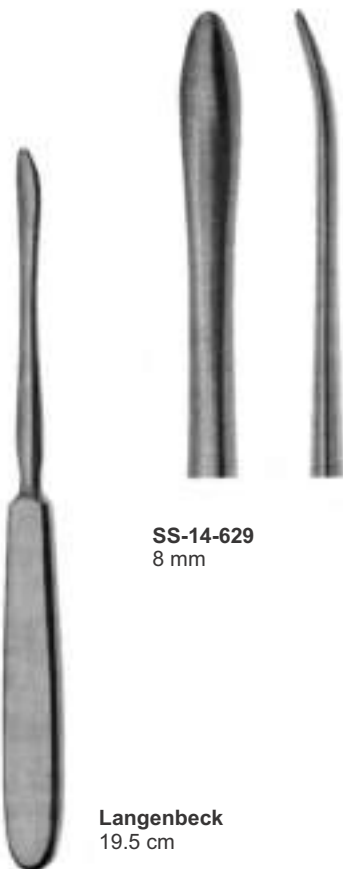
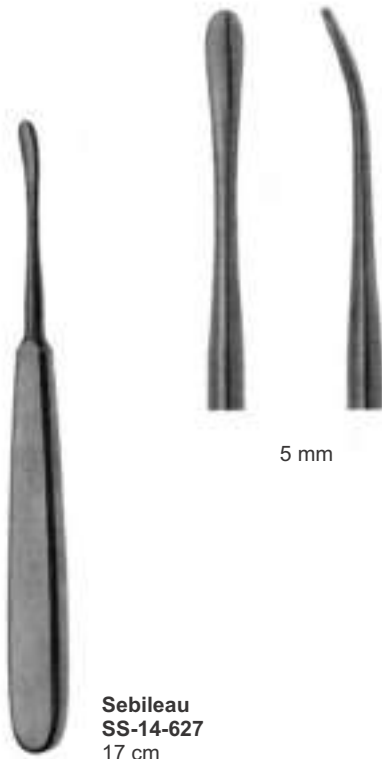

Bone Levers
Elevadores para huesos
Leviers a os

3 mm



SS-14-632
14.5 cm

6 mm



SS-14-633
14.5 cm

7 mm



SS-14-634
15 cm

6 mm

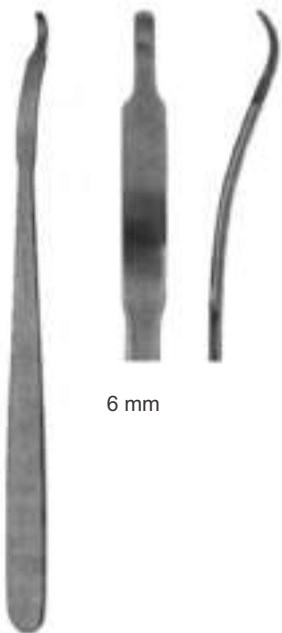

Mini-Hohmann
SS-14-635
16 cm

8 mm

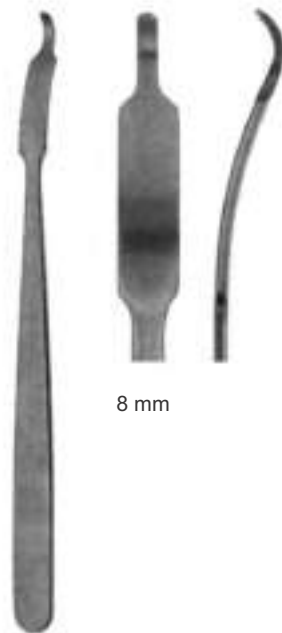

Mini-Hohmann
SS-14-636
16 cm

7.5 mm

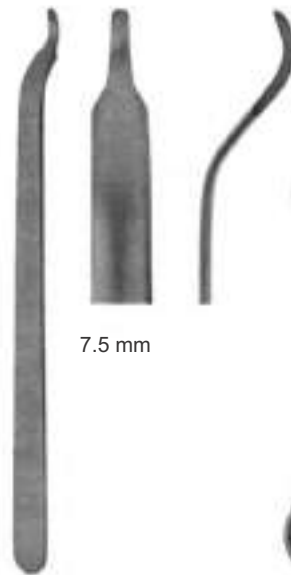

Buck-Gramcko
SS-14-637
15 cm

16 mm



SS-14-638
12 cm

Bone Levers
 Elevadores para huesos
 Leviers a os



17 mm



24 mm



30 mm



Wagner
SS-14-639
 22 cm



Lange-Hohmann
SS-14-640
 25.5 cm



Lange-Hohmann modif.
SS-14-641
 26.5 cm

Bone Levers
Elevadores para huesos
Leviers a os



9 mm



18 mm



18 mm



24 mm



Hohmann
SS-14-642
22 cm



Hohmann
SS-14-643
24 cm



Hohmann
SS-14-644
25.5 cm



Hohmann
SS-14-645
26 cm

Bone Levers
 Elevadores para huesos
 Leviers a os



35 mm



43 mm



64 mm



Hohmann
SS-14-646
 28.5 cm



Verbrugge-Muller
SS-14-647
 24 cm



Verbrugge-Muller
SS-14-648
 25.5 cm



SAPTESTAR
Manufacturer & Exporter Of Surgical, Dental & Veterinary Instruments

Bone Levers
Elevadores para huesos
Leviers a os



25 mm



24 mm



34 mm



45 mm



**Hohmann
SS-14-649**
27 cm
Bone lever
elevador para hueso
Levier a' os



**Hohmann-Aldinger
SS-14-650**
28.5 cm
Bone lever
elevador para hueso
Levier a' os



**Blount
SS-14-651**
26 cm
Hib lever
elevador para cadera
eleveur pour la hanche



**Blount
SS-14-652**
26 cm
Hib lever
elevador para cadera
eleveur pour la hanche

Bone Levers
 Elevadores para huesos
 Leviers a os



SS-14-653
 45 mm



SS-14-654
 60 mm



30 mm



18 mm



Bennet
 25 cm
 Bone levers
 Elevadores para huesos



30 mm



18 mm

Murphy-Lane
SS-14-655
 30 cm
 Luxation lever
 Elevador para luxacion

Raspatories
 Periostotomos
 Rugines-raspatories

4 mm

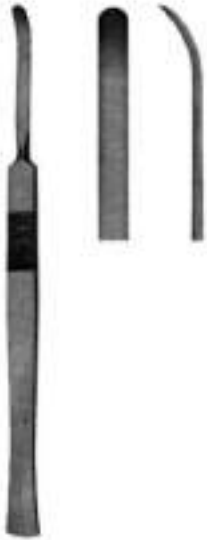

Mc Kenty
SS-14-656
 14.5 cm

5 mm



Konig
SS-14-657
 15.5 cm

4 mm



Willger
SS-14-658
 14 cm

6 mm



Willger
SS-14-659
 16 cm

6 mm



Sewall
SS-14-663
 20 cm

3 mm



Halle
SS-14-662
 18 cm

4 mm



Joseph
SS-14-661
 17 cm

8 mm



Trelat
SS-14-660
 15 cm

½

Raspatories
 Periostotomos
 Rugines-raspatories

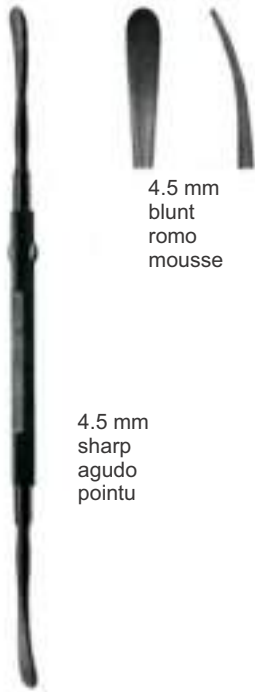

4.5 mm
 blunt
 romo
 mousse

4.5 mm
 sharp
 agudo
 pointu

Freer
SS-14-664
 19.5 cm

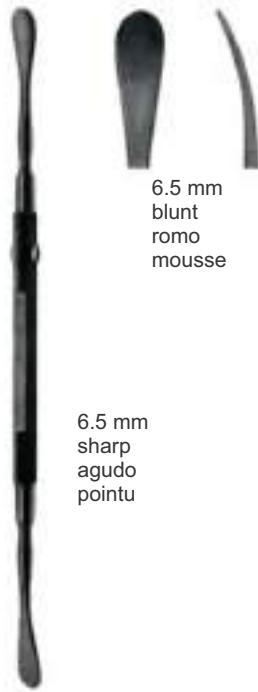

6.5 mm
 blunt
 romo
 mousse

6.5 mm
 sharp
 agudo
 pointu

Freer
SS-14-665
 19.5 cm



4.5 mm
 blunt
 romo
 mousse

Freer
SS-14-666
 19.5 cm



4.5 mm
 sharp
 agudo
 pointu

Freer
SS-14-667
 19.5 cm



3.5 mm
 blunt
 romo
 mousse

3.5 mm
 sharp
 agudo
 pointu

Killian
SS-14-668
 18.5 cm

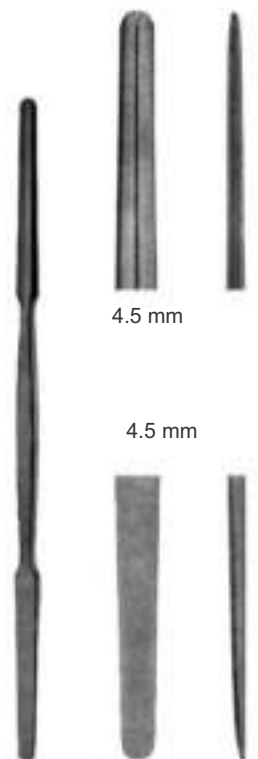

4.5 mm

4.5 mm

Killian
SS-14-669
 19 cm

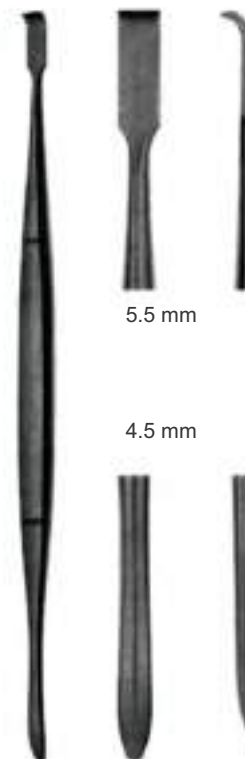

5.5 mm

4.5 mm

Howard
SS-14-670
 21.5 cm

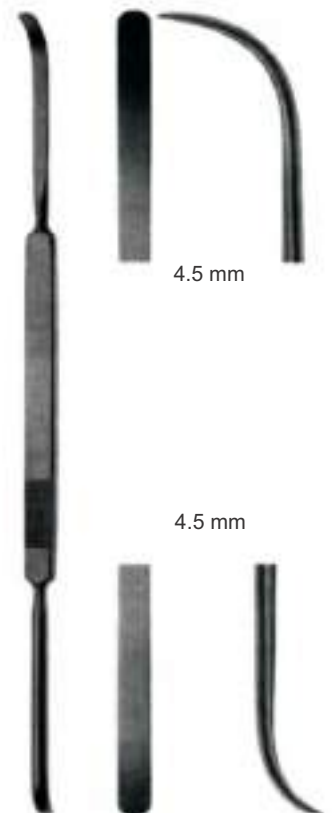

4.5 mm

4.5 mm

Cottle
SS-14-671
 23 cm

Raspatories
 Periostotomos
 Rugines-raspatories



17 cm



SS-14-672
 6 mm



SS-14-673
 8 mm



Lempert
 17 cm



SS-14-674
 2 mm



SS-14-675
 3 mm



SS-14-676
 4 mm



SS-14-677
 5 mm



Muhling
 --



SS-14-678
 4 mm



SS-14-679
 4 mm



SS-14-680
 4 mm



SS-14-681
 6 mm

Raspatories
Periostotomos
Rugines-raspatories



17 cm



SS-14-682
3 mm



SS-14-683
6 mm



Landolt
SS-14-684
17.5 cm



4.5 mm



Caspar
SS-14-685
18 cm



6 mm



Caspar
SS-14-686
18 cm



6 mm



Cottle
SS-14-687
19 cm



9 mm

Raspatories
 Periostotomos
 Rugines-raspatories



Adson
 17 cm



SS-14-688
 8 mm



SS-14-689
 7 mm



SS-14-690
 7 mm



SS-14-691
 7 mm



Sedillot
SS-14-692
 19 cm

18 mm



Hoen
SS-14-693
 16 cm



6 mm



Hoen
SS-14-694
 19 cm

15 mm



Hoen
SS-14-695
 19 cm

20 mm



Sedillot
SS-14-696
 22 cm

15 mm

Raspatories
 Periostotomos
 Rugines-raspatories



Jansen
SS-14-697
 16.5 cm



Langenbeck
SS-14-698
 19.5 cm



Langenbeck
SS-14-699
 18 cm



Langenbeck
SS-14-700
 19.5 cm



Langenbeck
SS-14-701
 19.5 cm



Langenbeck
SS-14-702
 19 cm



Langenbeck
SS-14-703
 18 cm

Raspatories
Periostotomos
Rugines-raspatories



**Schneider
SS-14-704**
17.5 cm



**Schneider-Sauerbruch
SS-14-705**
19 cm



**Farabeuf
SS-14-706**
15 cm



**Farabeuf
SS-14-707**
15 cm



**Farabeuf-Collin
SS-14-708**
15.5 cm



**Farabeuf-Collin
SS-14-709**
15.5 cm

Raspatories
Periostotomos
Rugines-raspatories



3.0 mm

SS-14-710
17.5 cm



6.5 mm

SS-14-711
17.5 cm



9.5 mm

SS-14-712
19 cm



12.5 mm

SS-14-713
19 cm



16.0 mm

SS-14-714
20 cm



19.5 mm

SS-14-715
20 cm



24.5 mm

SS-14-716
21 cm



10.0 mm

SS-14-717
28.5 cm



13.0 mm

SS-14-718
28.5 cm



19.0 mm

SS-14-719
28.5 cm



25.0 mm

SS-14-720
28.5 cm



Key



Cobb



SAPTESTAR
Manufacturer & Exporter Of Surgical, Dental & Veterinary Instruments

Raspatories with handle from artificial wood
Periostotomos con mango de madera artificial
Rugines-raspatories avec manche en "Ferozell"

6 mm



SS-14-721
19 cm

3 mm



SS-14-722
19 cm

6 mm



SS-14-723
19 cm

6 mm



SS-14-724
19 cm

12 mm



SS-14-725
19.5 cm

13 mm



SS-14-726
20.5 cm

13 mm



SS-14-727
20 cm

20 mm



SS-14-728
20.5 cm

Raspatories with handle from artificial wood
Periostotomos con mango de madera artificial
Rugines-raspatories avec manche en "Ferozell"



SS-14-729
10 mm



SS-14-730
13 mm



SS-14-731
19 mm



SS-14-732
25 mm

21 mm



SS-14-733
27.5 cm



SS-14-734
8 mm



SS-14-735
17 mm



Cobb
25 cm



Wagner
33 cm

Can be autoclaved at 3 bar overpressure (143°)
Esterilizables en autoclave a 3 bar sobrepresion (143°)
Sterilisables a l' autoclave a' 3 bara ((143°))

Bone Files, Rasps
 Limas para huesos, Escofinas
 Limes a os, Rapes



Joseph
SS-14-736
 16.5 cm



Gallaher
SS-14-737
 17 cm



Lewis
 18 cm



SS-14-738
 fine
 fina
 denture fine



SS-14-739
 coarse
 gruesa
 denture grosse



Miller
 18 cm



SS-14-740



SS-14-741



SS-14-742



Rasps
 Escofinas
 Rapes



Maltz
SS-14-743
 18 cm

Ø 3.5 mm



Cottle
SS-14-744
 21 cm

Ø 3.5 mm



Aufricht
 20.5 cm



SS-14-745
 up stroke
 a presion
 a pousser



SS-14-746
 down stroke
 a traccion
 a tirer



Wiener
SS-14-747
 19.5 cm



Wiener
SS-14-748
 19.5 cm



Brawley
SS-14-749
 19.5 cm



Watson-Williams
SS-14-750
 22 cm

Ø 3.7 mm

Bone Files, Rasps
Limas para huesos, Escofinas
Limes a os, Rapes



20 mm

18 mm

Putti
SS-14-751
27 cm



10 mm

16 mm

Putti
SS-14-752
30 cm



13 mm

SS-14-753
24.5 cm



20 mm

SS-14-754
28.5 cm

Bone Holding Forceps
Pinzas para huesos
Daviers



SS-14-456
fine
fina
denture fine

SS-14-757
coarse
guesa
denture grosse

20 mm



SS-14-755
22 cm
file cut / rasp cut
filo de lima / filo de escofina
coupe lime / coupe rape



Fomon
21.5 cm
file cut / rasp cut
filo de lima / filo de escofina
coupe lime / coupe rape





SAPTESTAR
 Manufacturer & Exporter Of Surgical, Dental & Veterinary Instruments

Osteotomes, Chisels, Gouges
 Osteotomos, Cinceles, Gubias
 Osteotomes, Ciseaux-burins, Gouges



Hoke
SS-14-458 2 mm
SS-14-759 3 mm
SS-14-760 4 mm
SS-14-761 5 mm
SS-14-762 6 mm
SS-14-763 7 mm
SS-14-764 8 mm
 14 cm
 Osteotomes
 Oateotomos
 Osteotomes



Hoke
SS-14-465 2 mm
SS-14-766 3 mm
SS-14-767 4 mm
SS-14-768 5 mm
SS-14-769 6 mm
SS-14-770 7 mm
SS-14-771 8 mm
 14 cm
 Osteotomes
 Oateotomos
 Osteotomes

4 mm



Freer
SS-14-772
 17 cm
 Chisel
 Cincel
 Ciseaux-burins

4 mm



Freer
SS-14-773
 17 cm
 Chisel
 Cincel
 Ciseaux-burins

4 mm



West
SS-14-774
 16 cm
 Chisel
 Cincel
 Ciseaux-burins

4 mm



West
SS-14-775
 16 cm
 Gouge
 Gubia
 Gouges

6 mm



West
SS-14-776
 19 cm
 Chisel
 Cincel
 Ciseaux-burins

6 mm



West
SS-14-777
 19 cm
 Gouge
 Gubia
 Gouges

Osteotomes
Osteotomos
Osteotomes



Cottle
SS-14-778 4 mm
SS-14-779 6 mm
SS-14-780 8 mm
SS-14-781 10 mm
SS-14-782 12 mm
 18 cm
 with depth markings
 graduado
 gradue



Cottle
SS-14-783
 18 cm
 with depth markings
 graduado
 gradue



Mini-Lambotte
SS-14-784 2 mm
SS-14-785 3 mm
SS-14-786 4 mm
SS-14-787 6 mm
SS-14-788 8 mm
SS-14-789 10 mm
SS-14-790 12 mm
SS-14-791 15 mm
 12.5 cm



Mini-Lambotte
SS-14-792 2 mm
SS-14-793 3 mm
SS-14-794 4 mm
SS-14-795 6 mm
SS-14-796 8 mm
SS-14-797 10 mm
SS-14-798 12 mm
SS-14-799 15 mm
 17 cm

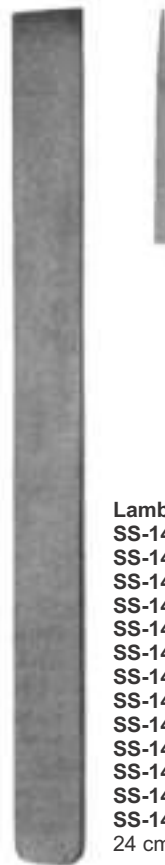

Lambotte
SS-14-800 4 mm
SS-14-801 6 mm
SS-14-802 8 mm
SS-14-803 10 mm
SS-14-804 13 mm
SS-14-805 15 mm
SS-14-806 10 mm
SS-14-807 20 mm
SS-14-808 25 mm
SS-14-809 30 mm
SS-14-810 38 mm
SS-14-811 44 mm
SS-14-812 50 mm
 24 cm

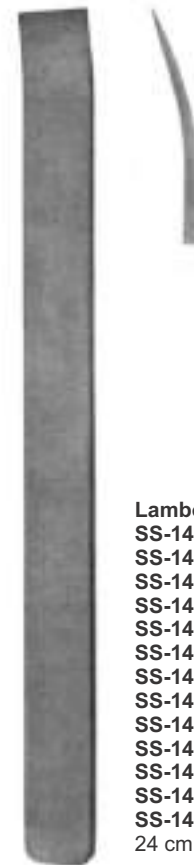

Lambotte
SS-14-813 4 mm
SS-14-814 6 mm
SS-14-815 8 mm
SS-14-816 10 mm
SS-14-817 13 mm
SS-14-818 15 mm
SS-14-819 18 mm
SS-14-820 20 mm
SS-14-821 25 mm
SS-14-822 30 mm
SS-14-823 38 mm
SS-14-824 44 mm
SS-14-825 50 mm
 24 cm



SAPTESTAR
 Manufacturer & Exporter Of Surgical, Dental & Veterinary Instruments

Osteotomes, Chisels, Gouges
 Osteotomos, Cinceles, Gubias
 Osteotomes, Ciseaux-burins, Gouges



SS-14-826 4 mm
SS-14-827 6 mm
SS-14-828 8 mm
SS-14-829 10 mm
SS-14-830 12 mm
 13.5 cm
 Osteotomes
 Osteotomos
 Osteotomes



SS-14-831 4 mm
SS-14-832 6 mm
SS-14-833 8 mm
SS-14-834 10 mm
SS-14-835 12 mm
 13.5 cm
 Chisels
 Cinceles
 Ciseaux-burins



SS-14-836 4 mm
SS-14-837 6 mm
SS-14-838 8 mm
SS-14-839 10 mm
SS-14-840 12 mm
 13.5 cm
 Gouges
 Gubias
 Gouges



Alexander
SS-14-841 4 mm
SS-14-842 6 mm
SS-14-843 8 mm
SS-14-844 10 mm
SS-14-845 12 mm
 17.5 cm
 Osteotomes
 Osteotomos
 Osteotomes



Alexander
SS-14-846 4 mm
SS-14-847 6 mm
SS-14-848 8 mm
SS-14-849 10 mm
SS-14-850 12 mm
 17.5 cm
 Chisel
 Cinceles
 Ciseaux-burins



Alexander
SS-14-851 4 mm
SS-14-852 6 mm
SS-14-853 8 mm
SS-14-854 10 mm
SS-14-855 12 mm
 17.5 cm
 Gouges
 Gubias
 Gouges



Stille
SS-14-856 10 mm
SS-14-857 12 mm
SS-14-858 15 mm
SS-14-859 20 mm
SS-14-860 25 mm
 20.5 cm
 Osteotomes
 Osteotomos
 Osteotomes



Stille
SS-14-861 8 mm
SS-14-862 10 mm
SS-14-863 12 mm
SS-14-864 15 mm
SS-14-865 20 mm
SS-14-866 25 mm
SS-14-867 30 mm
 20.5 cm
 Osteotomes
 Osteotomos
 Osteotomes



Stille
SS-14-868 10 mm
SS-14-869 12 mm
SS-14-870 15 mm
SS-14-871 20 mm
SS-14-872 25 mm
 20.5 cm
 Chisels
 Cinceles
 Ciseaux-burins



Stille
SS-14-873 10 mm
SS-14-874 12 mm
SS-14-875 15 mm
SS-14-876 20 mm
SS-14-877 25 mm
 20.5 cm
 Gouges
 Gubias
 Gouges

Osteotomes, Chisels, Gouges
 Osteotomos, Cinceles, Gubias
 Osteotomes, Ciseaux-burins, Gouges

Can be autoclave at 3 bar overpressure (143°C)
 Esterilizables en autoclave a 3 bar sobrepresion (143°C)
 Sterilisables a l' autoclave a 3 bars (143°C)



SS-14-878
 18.5 cm
 Handle or interchangeable blades,
 with key (SS-14-841)
 Mango para hojas intercambiables,
 con llave (SS-14-841)
 Manche pour lames interchangeables
 avec clef (SS-14-841)



BC-14-879



SS-14-880 5 mm
SS-14-881 10 mm
SS-14-882 16 mm
SS-14-883 25 mm
 Interchangeable osteotome blades
 Osteotomos, hoja intercambiable
 Lames-osteotomes interchangeables

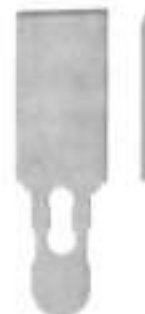

SS-14-884 5 mm
SS-14-885 10 mm
SS-14-886 16 mm
SS-14-887 25 mm
 Interchangeable chisel blades
 Cinceles, hojas intercambiable
 Lames-ciseaux-burins interchangeables



SS-14-888 25 mm (r= 50 mm)
SS-14-889 25 mm (r= 60 mm)
SS-14-890 25 mm (r= 70 mm)
 Interchangeable gouges blades
 Gubias, hojas intercambiable
 Lames-gouges interchangeables

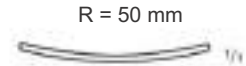

R = 50 mm

SS-14-888

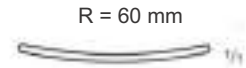

R = 60 mm

SS-14-889

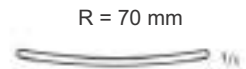

R = 70 mm

SS-14-890

Chisels, Gouges Osteotomes,
Osteotomos, Cinceles, Gubias
Osteotomes, Ciseaux-burins, Gouges



Lexer
SS-14-891 10 mm
SS-14-892 15 mm
27.5 cm
Osteotomes, angled
Osteotomos, acodados
Osteotomes, angules



Lexer
SS-14-893 10 mm
SS-14-894 15 mm
27.5 cm
Gouges, angled
Gubias, acodadas
Gouges, angules



SS-14-895 10 mm
SS-14-896 15 mm
16 cm
Chisels
Cinceles
Ciseaux-burins



SS-14-897 10 mm
SS-14-898 15 mm
SS-14-899 20 mm
20 cm
Chisels
Cinceles
Ciseaux-burins



SS-14-900 10 mm
SS-14-901 15 mm
SS-14-902 20 mm
20 cm
Chisels
Cinceles
Ciseaux-burins

Osteotomes, Chisels
 Osteotomos, Cinceles
 Osteotomes, Ciseaux-burins

Can be autoclave at 3 bar overpressure (143°C)
 Esterilizables en autoclave a 3 bar sobrepresion (143°C)
 Sterilisables a l' autoclave a 3 bars (143°C)



Mini-Lexer
SS-14-903 4 mm
SS-14-904 6 mm
SS-14-905 8 mm
SS-14-906 10 mm
SS-14-907 12 mm
 18 cm
 Osteotomes
 Osteotomos
 Osteotomes



Mini-Lexer
SS-14-908 4 mm
SS-14-909 6 mm
SS-14-910 8 mm
SS-14-911 10 mm
SS-14-912 12 mm
 18 cm
 Gouges
 Gubias
 Gouges



Lexer
SS-14-913 5 mm
SS-14-914 7 mm
SS-14-915 10 mm
SS-14-916 15 mm
SS-14-917 20 mm
SS-14-918 25 mm
SS-14-919 30 mm
 22 cm
 Osteotomes
 Osteotomos
 Osteotomes



Lexer
SS-14-920 5 mm
SS-14-921 7 mm
SS-14-922 10 mm
SS-14-923 15 mm
SS-14-924 20 mm
SS-14-925 25 mm
SS-14-926 30 mm
 22 cm
 Gouges
 Gubias
 Gouges

Chisels, Gouges
Cinceles, Gubias
Ciseaux-burins, Gouges

Can be autoclave at 3 bar overpressure (143°C)
Esterilizables en autoclave a 3 bar sobrepresion (143°C)
Sterilisables a l' autoclave a 3 bars (143°C)



SS-14-927
24.5 cm
Chisel
Cinzel
Ciseaux-burins

SS-14-928
26.5 cm
Chisel
Cinzel
Ciseaux-burins

SS-14-929
22 cm
Gouge for removing
broken screw
Gubias para exteriorizar
tornillos truncados
Gouge pour extraire
les vis cassees

Zielke
SS-14-930 5.5 mm
SS-14-931 9.0 mm
23 cm
Gouge for scoliosis
operations
Gubias para operaciones
scoliosis
Gouge pour scoliose

Gouges with handle from artificial wood
Gubias con mango de madera artificial
Gouges avec manche en "Ferrozell"

Can be autoclave at 3 bar overpressure (143°C)
Esterilizables en autoclave a 3 bar sobrepresion (143°C)
Sterilisables a l' autoclave a 3 bars (143°C)



SS-14-932 5 mm
SS-14-933 10 mm
SS-14-934 15 mm
25 cm
Spongiosa gouges
Gubias de esponjosa
Ciseaux-burins spongiose



SS-14-935 5 mm
SS-14-936 10 mm
SS-14-937 15 mm
25 cm
Spongiosa gouges
Gubias de esponjosa
Ciseaux-burins spongiose



Lexer
SS-14-938 7 mm
SS-14-939 10 mm
28.5 cm
Spongiosa gouges
Gubias de esponjosa
Ciseaux-burins spongiose



SAPTESTAR

Manufacturer & Exporter Of Surgical, Dental & Veterinary Instruments



+92-340-4040061



exportsaptestar@gmail.com



info@saptestar.com



www.saptestar.com



Defence Road, Near Hotel Javson, 51310-Sialkot Pakistan





Dressing 15

15 Dressing

Bandage Scissors	154-156
Bergmann	158
Bruns	159
Cloth Scissors	156-158
Engel	153
Esmarch	153,157
Hennig	162
Hopkins	153
Knowles	155
Lange	154
Lister	155,156
Lister Modif.	155
Mod. Usa	162
Plaster Knives	153
Plaster Spreaders	162
Plaster Of-Paris Shears	157-161
Reiner	153
Seutin	158
Smith	154
Stille	160,161
Stille-Mini	161
Wolff	162

Plaster Knives
 Cuchillos para escayolas
 Couteaux pour appareils platres



Esmarch
SS-15-101
 18 cm
 Plaster Knife
 Cuchillos para escayolas
 Couteaux pour appareils platres
 Coltello per gessi



Reiner
SS-15-102
 18 cm
 Plaster Knife
 Cuchillos para escayolas
 Couteaux pour appareils platres
 Coltello per gessi



Hopkins
SS-15-103
 20 cm
 Plaster Knife with
 ebony handle
 Cuchillos para escayolas
 con mango de ebano
 Couteaux pour appareils
 platres avec manche ebonite



Hopkins
SS-15-104
 20.5 cm
 Plaster Knife with
 ebony handle
 Cuchillos para escayolas
 con mango de ebano
 Couteaux pour appareils
 platres avec manche ebonite



Engel
SS-15-105
 15 cm
 Plaster saw
 Sierra para escayolas
 Scie pour appareils platres

1/2

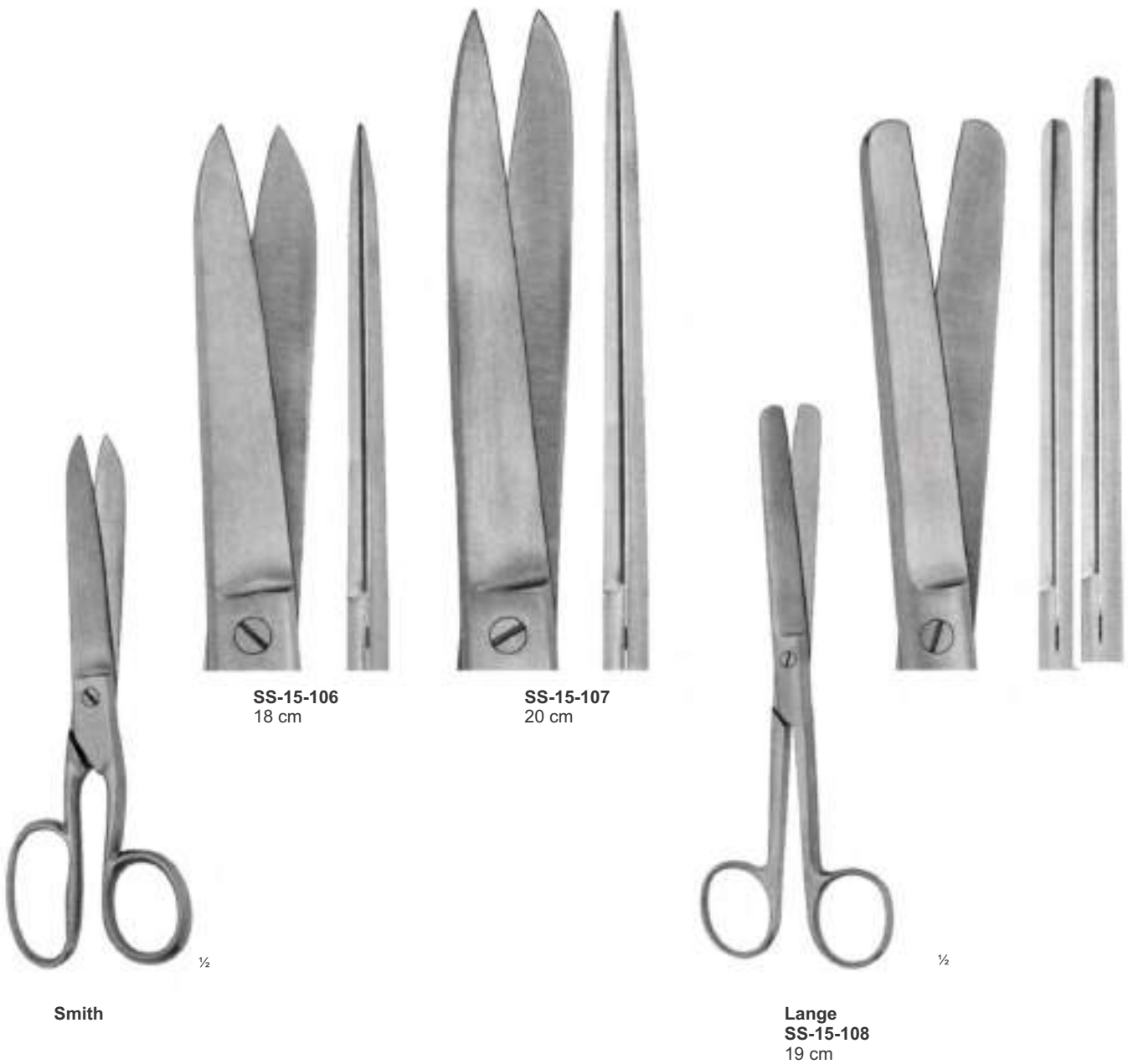

Bandage Scissors
Tijeras para vendajes
Ciseaux a pansements



1/2

Knowles
SS-15-109
14.5 cm
for finger bandges
para vendajes de dedos
pour bandages des doigts



1/2

Lister modif.
SS-15-110
14.5 cm
1 blade serrated
1 hoja dentada
1 lame dentelee



Lister
SS-15-111
18 cm
with tungsten carbide edges
con fillos de carburo tungsteno
avec des lames en tungstene



Lister



SS-15-112
11.5 cm



SS-15-113
14.5 cm



SS-15-114
18 cm



SS-15-115
20 cm

Bandage & cloth Scissors
Tijeras para vendajes y tela
Cisailles a pansements et etoffes d'habillement



Lister
SS-15-116
14.5 cm

Universal bandage and cloth scissors, made of acid-proof stainless steel, with 1 serrated blade and plastic handles, autoclavable up to 134°C.

Tijera universal para vendajes y tela, acero inoxidable y resistente a los acidos, con 1 hoja dentada y mangos de plastico, esterilizable en autoclave hasta 134°C.

Ciseaux universels pour etoffes en acier inox, avec 1 lame crantee et anneaux en plastique, autoclavables a 134°C.

SS-15-117
18 cm

Universal bandage and cloth scissors, made of acid-proof stainless steel, with 1 serrated blade and plastic handles, autoclavable up to 134°C.

Tijera universal para vendajes y tela, acero inoxidable y resistente a los acidos, con 1 hoja dentada y mangos de plastico, esterilizable en autoclave hasta 134°C.

Ciseaux universels pour etoffes en acier inox, avec 1 lame crantee et anneaux en plastique, autoclavables a 134°C.

Cloth Scissors, Plaster-of-Paris Shears
Tijeras para tela, Cizallas para escayolas
Cisailles pour etoffes d'habillement et appareils plats



Cloth Scissors, Plaster-of-Paris Shears
Tijeras para tela, Cizallas para escayolas
Cisailles pour etoffes d'habillement et appareils platres



Bergmann
SS-15-121
23 cm



Seutin
SS-15-122
23 cm

Plaster-of-Paris Shears
Cizallas para escayolas
Cisailles pour appareils platres



Brun's
SS-15-123
24 cm
with tungsten carbide edges
con filos de carburo tungsteno
avec des lames en tungstene



Brun's
SS-15-124
24 cm



Brun's
SS-15-125
24 cm
1 blade serrated
1 hoja dentada
1 lame dentelee

Plaster-of-Paris Shears
Cizallas para escayolas
Cisailles pour appareils platres



SS-15-126
23 cm



SS-15-127
27 cm



SS-15-128
37.5 cm



Stille
blade with reinforced back
hoja con espalda reforzada
lame avec dos renforce

1/2

Plaster-of-Paris Shears
Cizallas para escayolas
Cisailles pour appareils platres



½

Stille-Mini
SS-15-129
19.5 cm
for small plaster dressings
para escayolas pequenas
pour petits pansements platres



½

Stille
SS-15-130
24.5 cm

Plaster Spreaders
 Separadores para escayolas
 Pinces ecartantes a platre



SS-15-133
 17.5 cm

SS-15-134
 26.5 cm



Mod. USA
SS-15-131
 22.5 cm
 Plaster spreader
 Separador para escayolas
 pince ecartante a platre



Hennig
SS-15-132
 27 cm
 Plaster spreader
 Separador para escayolas
 pince ecartante a platre



Wolff
 Plaster breakers
 Pinza para romper escayolas
 Pince ecrasante a platre



SAPTESTAR



**Manufacturers & Exporters Of Quality Surgical Instruments
Cardiovascular Instruments Catalogue**

Group 16

Cardiovascular 16



+92-340-4040061



exportsaptestar@gmail.com



info@saptestar.com



www.saptestar.com



Defence Road, Near Hotel Javson, 51310-Sialkot Pakistan

Company Profile



ABOUT US

Quality begins at **SapteStar** Instruments Company where master craftsmen forge and manufacture each instrument to its exact specifications and measurements. Instruments must undergo a series of quality control inspections in order to be worthy of **SapteStar** name and warranty. We offer a wide selection of medical instruments including Surgical and Dental instruments.

We have acquired a unique and unmatched understanding of manufacturing through a large experience, working since 1908. Years of experience & state of the art manufacturing facilities helped us to keep our prices low. Our Surgical & Dental instruments are created by expert craftsmen, providing unfaltering quality you can rely on.

We have launched a fully interactive website where you can get online and track your orders 24 hours a day, 7 days in a week, and 365 days a year. Ask for our free e-catalogue on CD-Rom to save time and enjoy hassle free ordering.

We provide our customers with most reliable customer service as your satisfaction is our top priority. Our customers always enjoy our wonderful customer service and quality tools at the best price.

Lastly we invite you to have a work experience with SapteStar Instruments Company and we will prove ourselves as one of the most valuable source you have.

You can find us at

SapteStar
CEO



Company Profile



History

SAPTESTAR INSTRUMENTS was founded in 1995. Our Great Grandfather **Mian Muhammad Fazal Elahi** was the founder of M/s M.F. Elahi & Company (E.P.) Pvt. Ltd, established in 1908. SapteStar is a sister concern of M.F. Elahi & Co. It is our pride to be a member of M.F. Elahi Family.

SapteStar Instruments Company is located in the heart of beautiful city, Sialkot, Pakistan. We are manufacturers and exporters of quality Surgical, Dental instruments and Scissors of all sorts in various categories. We are closely attached with highly skilled surgeons and other technicians of the surgical industry to make the new instruments development possible.

SapteStar is in a continues process of development and testing of new instruments for their precision and perfect functioning. We are also working at imported forging supply by foreign customers.

Certificates

Instruments Company has achieved the certificates for ISO-9001, ISO-13485, cGMP (FDA) and CE Marking.

Quality Control

All material use in the manufacturing of our instruments are tested from relevant laboratories. Our continuous quality control is our best warranty so that you built confidence in our products.

Deliveries

Deliveries are quick and in-time.

Mode Of Payment

Terms of Payment is ADVANCE or LETTER OF CREDIT (Irrevocable)



CardioVascular 16

16 Cardiovascular Surgery

Adson	69	Lambert-Kay	46
Adson-brown	69	Lamotte	19
Alexander-farabeuf	19	Lebsche	2
Allison	14	Lees	49
Arteria	64, 65	Leland-Jones	31
Atraumatic Tissue Forcep	76	Lovelace	16
Baby-Satinsky	61	Matson	19
Bailey	13, 35	Mc Indoe	68
Bailey-Baby	13	Mercedes	22
Bailey-Gibbon	13	Morse	7
Bonney	68	Morse-Favaloro	7
Brunner	2	Ochsner	36
Burford- Finochietto	20, 21	Oehler	70
Calne	47	Potts-Smith	70
Castaneda	5	Price-Thomas	15, 62
Chevalier	22	Rib Shears	1
Cooley	03, 23, 24, 52-55, 57-59, 66	Sarot	62
Cooley-Beck	57	Sauerbruch	2
Cooley-Derra	56	Sellors	13
Cooley-Reynolds	56	Semb	15, 18
Crafoord	61	Semi Flexible Vascular	60
Cushing	69	Semken	68
Cushing-Taylor	69	Subramanian	34
Dale	32	Thoracic Retractors	12
Dardik	51	Tuffier	8
De Bakey	25-34, 36, 38, 41-44, 48, 50, 67, 71, 73	Vena	64, 65
De Bakey-Garrett	24	Wangesteen	71
De Bakey-Bahnon	42	Weber	45
De Bakey-Bainbridge	27	Wylie	46
De Bakey-Beck	34, 41, 47		
De Bakey-Crafoord	43		
De Bakey-Derra	39		
De Bakey-Diethrich	63		
De Bakey-Harken	48		
De Bakey-Morris	37		
De Bakey-Pean	26		
De Bakey-Potts	28		
De Bakey-Reynolds	39		
De Bakey-Satinsky	38		
De Bakey	10, 11		
Diethrich	63		
Diethrich	36		
Doyen	17		
Finochietto (Modif)	6		
Finochietto	4, 9, 21, 61		
Finochietto, Baby	4, 8, 21		
Finochietto, infant	4		
Gerald	68		
Gillies	68		
Glertz-Stille	2		
Glover	40		
Gluck	1		
Gregory	31		
Haight	6		
Jaboma	72		
Javid	34, 66		

Rib Shears
Costotomos
Costotmes



SS-16-101
23 cm
Bone Shears
Cizallas para hueso
Cisailles a os



SS-16-102
23 cm



Gluck
SS-16-103
21 cm

Drawing cut
corte oblicuo
lame qlissante

Rib Shears, Sternum Chisel
Costotomos, Cinceles
Costotomes, Ciseau-burin a sternum



Sauerbruch
SS-16-104
26 cm



Giertz-Stille
SS-16-105
24.5 cm



Brunner
SS-16-106
32 cm
for right hand
para la mano derecha
pour la main droite

SS-16-107
32 cm
for left hand
para la mano izquierda
pour la main gauche



Lebsche
SS-16-108
24.5 cm

Rib Retractors
Separadores costales
Ecarteurs des cotes



Cooley
SS-16-109
For babies
para recién nacidos
pour nourissons

Lateral blades hojas laterales valves laterales 12 x 16 mm	Spreading abertura ouverture 95 mm
---	---



Cooley
SS-16-110
SS-16-111
For Children
para niños
pour enfants

Lateral blades hojas laterales valves laterales 15 x 30 mm 21 x 44 mm	Spreading abertura ouverture 140 mm 150 mm
---	--



Cooley
SS-16-112
For adults
para adultos
pour adultes

Lateral blades hojas laterales valves laterales 35 x 50 mm	Spreading abertura ouverture 200 mm
---	--

Rib Retractors
Separadores costales
Ecarteurs des cotes



**Finochietto, Infant
SS-16-113**
For babies
para recién nacidos
pour nourissons

Lateral blades
hojas laterales
valves laterales
15 x 15 mm

Spreading
abertura
ouverture
75 mm



**Finochietto, Baby
SS-16-114**
For Children
para niños
pour enfants

Lateral blades
hojas laterales
valves laterales
31 x 31 mm

Spreading
abertura
ouverture
100 mm



**Finochietto
SS-16-115
SS-16-116
SS-16-117**
For adults
para adultos
pour adultes

Lateral blades
hojas laterales
valves laterales
40 x 45 mm
52 x 62 mm
85 x 65 mm

Spreading
abertura
ouverture
135 mm
175 mm
175 mm

Rib Retractors
Separadores costales
Ecarteurs des cotes



**Castaneda
SS-16-118**
For babies
para recién nacidos
pour nourissons

Lateral blades
hojas laterales
valves laterales
10.5 x 32 mm

Spreading
abertura
ouverture
65 mm



**Castaneda
SS-16-119**
For infants
para bebés
pour petits enfants

Lateral blades
hojas laterales
valves laterales
12 x 45 mm

Spreading
abertura
ouverture
70 mm



**Castaneda
SS-16-120**
For infants
para bebés
pour petits enfants

Lateral blades
hojas laterales
valves laterales
15 x 60 mm

Spreading
abertura
ouverture
120 mm

Rib Retractors
Separadores costales
Ecarteurs des cotes



**Finochietto (modif.)
SS-16-121**

Lateral blades
hojas laterales
valves laterales
14 x 15 mm

Spreading
abertura
ouverture
120 mm



**Haight
SS-16-122**

Lateral blades
hojas laterales
valves laterales
30 x 30 mm

Spreading
abertura
ouverture
120 mm

Sternal Retractors
 Separadores esternales
 Ecarteurs a sternum



Morse-Favaloro
SS-16-123
 for children
 para niños
 pour enfants

4 movable blades
 4 valvas moviles
 4 valves mobiles
 17 x 22 mm

Spreading
 abertura
 ouverture
 160 mm

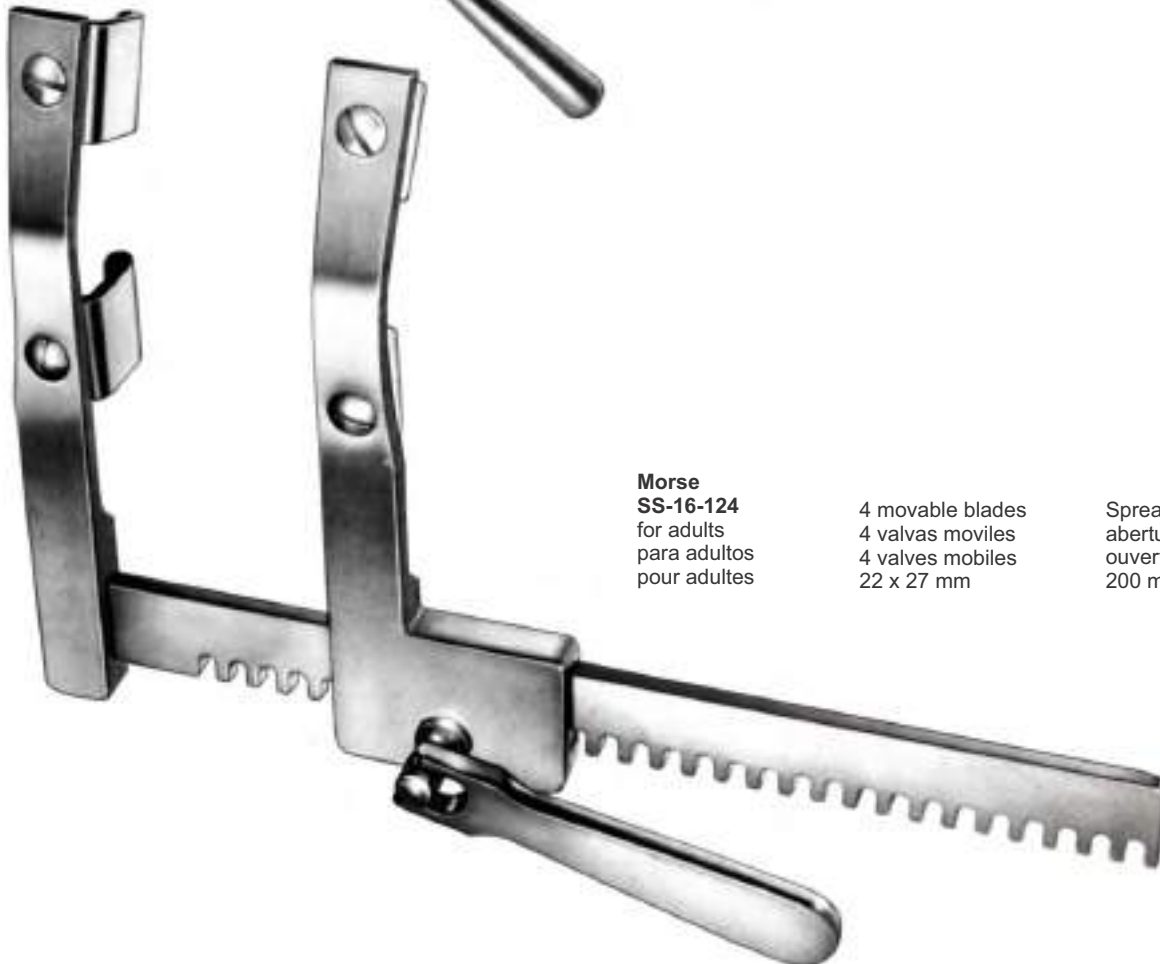

Morse
SS-16-124
 for adults
 para adultos
 pour adultes

4 movable blades
 4 valvas moviles
 4 valves mobiles
 22 x 27 mm

Spreading
 abertura
 ouverture
 200 mm

Rib Retractors
Separadores costales
Ecarteurs des cotes



Tuffier
SS-16-125

Lateral blades
hojas laterales
valves laterales
45 x 45 mm

Spreading
abertura
ouverture
160 mm



Finochietto, Baby
SS-16-126

Lateral blades
hojas laterales
valves laterales
14 x 15 mm

Spreading
abertura
ouverture
75 mm



Finochietto

SS-16-127
SS-16-127A
SS-16-127B

Lateral blades
hojas laterales
valves laterales
30 x 45 mm
46 x 62 mm
80 x 65 mm

Spreading
abertura
ouverture
150 mm
190 mm
190 mm

Rib Retractors
 Separadores costales
 Ecarteurs des cotes



DeBakey
SS-16-128
 Retractor only
 Separadore suelto
 Ecarteurs seul

SS-16-129
 With 3 pairs of blades
 con 3 pares de valvas
 avec 3 paires de valves

spreading
 abertura
 ouverture
 200 mm



Fig. 1



Fig. 2



Fig. 3



Fig. 4



Fig. 5

SS-16-130 = Fig. 1 60 x 60 mm
SS-16-131 = Fig. 2 50 x 80 mm
SS-16-132 = Fig. 3 40 x 100 mm
SS-16-133 = Fig. 4 80 x 60 mm
SS-16-134 = Fig. 6 50 x 66 mm

Rib Retractors
Separadores costales
Ecarteurs des cotes

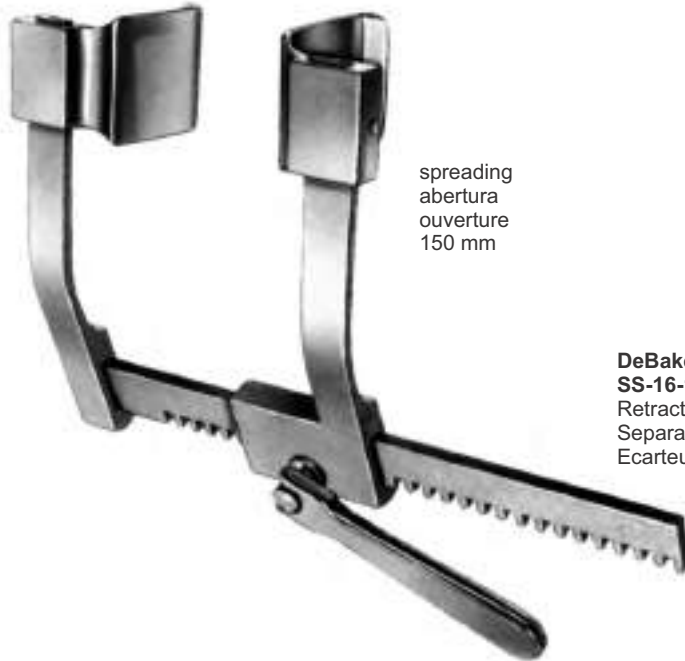

spreading
abertura
ouverture
150 mm

With 3 pairs of blades
con 3 pares de valvas
avec 3 paires de valves
SS-16-136

DeBakey
SS-16-135
Retractors only
Separadores suelto
Ecarteurs seul

Fig. 1



Fig. 2



Fig. 3



Laterals blades
Valvas Laterales
Valves Laterales
SS-16-137 = Fig. 1 30 x 30 mm
SS-16-138 = Fig. 2 40 x 40 mm
SS-16-139 = Fig. 3 50 x 50 mm

Thoracic Retractors
 Separadores toracico
 Ecarteurs thoracique



(Mercedes Retractor)
 (Retractor Mercedes)
 (Ecarteur Mercedes)
 SS-16-140

With 1 pair of blades each
 con 1 par de valvas de c.u
 avec chaqun 1 paire de valves
 SS-16-142 - SS-16-143

Retractor only
 Separador suelto
 Valves laterales
 SS-16-141



Fig. 1



Fig.2

Lateral Blades	pair
Valvas Laterales	par
Valves Laterales	paire
SS-16-142 = Fig.1	48 x 68 mm
SS-16-143 = Fig. 2	70 x 75 mm

Rib Contractors
Aproximadores para costillas
Rapprocheurs des cotes



Sellers
SS-16-144
20 cm



Bailey-Baby
SS-16-145
15.5 cm



Bailey
SS-16-146
20 cm
short claws
garras cortas
bras courts



Bailey-Gibbon
SS-16-147
20 cm
long claws
garras largas
bras longs

Lung Spatulas
Espatulas pulmonares
Spatules pulmonaires



SS-16-148
29.5 cm

SS-16-149
32.5 cm

Allison

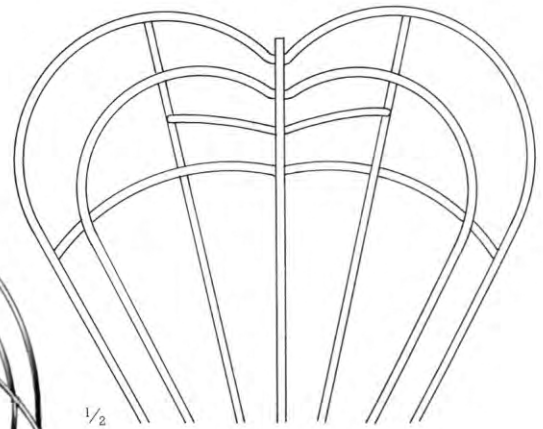

SS-16-150
26 cm

Bronchus Clamps
 Pinzas bronquiales
 Pince-clamps a bronches



SS-16-151
 22 cm



SS-16-152
 22 cm



SS-16-154
 24.5 cm



SS-16-155
 24 cm



SS-16-153
 22 cm



Price-Thomas



Price-Thomas



Semb

Lung Grasping Forceps
Pinzas para coger el pulmon
Pince-clamps au poumon

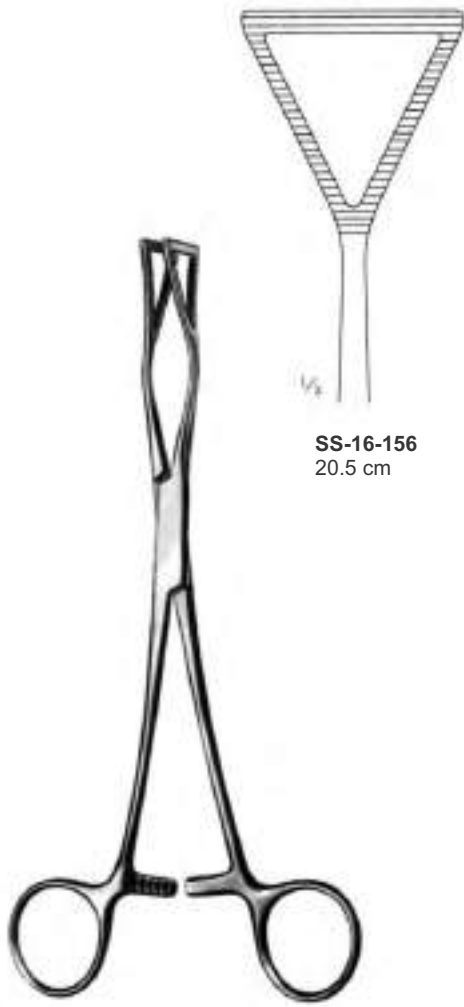

SS-16-156
20.5 cm

Lovelace

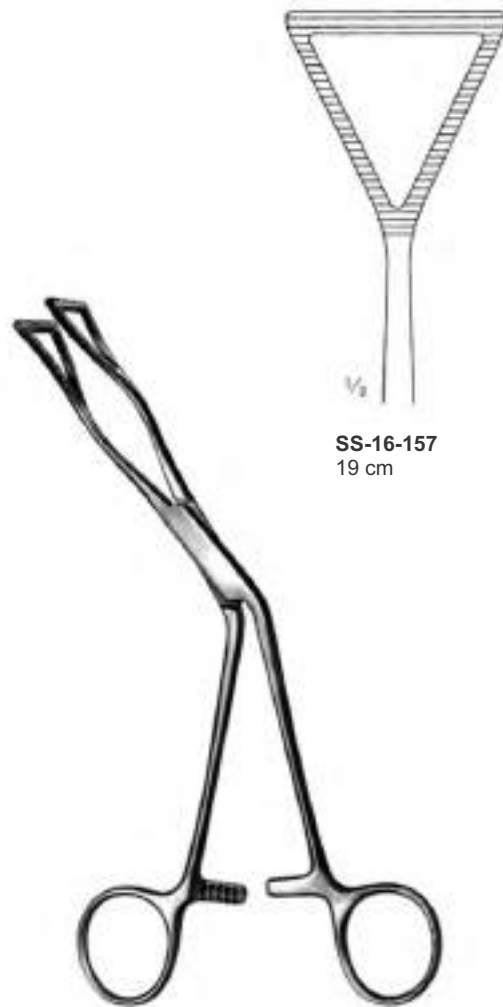

SS-16-157
19 cm

Lovelace
Laterally curved
Lateralmente curva
courbe lateralement

Rib Raspatories
Periostotomos costales
Rugines a costales



**Doyen
SS-16-158**
15.5 cm
for children, right
para niños, derecha
pour enfants, a droite



**Doyen
SS-16-159**
15.5 cm
for children, left
para niños, izquierda
pour enfants, a gauche



**Doyen
SS-16-160**
18 cm
for children, right
para niños, derecha
pour enfants, a droite



**Doyen
SS-16-161**
15.5 cm
for children, left
para niños, izquierda
pour enfants, a gauche



**Doyen
SS-16-162**
17 cm
for adults, right
para adultos, derecha
pour adultes, a droite



**Doyen
SS-16-163**
17 cm
for adults, left
para adultos, izquierda
pour adultes, a gauche

Rib Raspatories
Periostotomos costales
Rugines a costales



Rib Raspatories
Periostotomos costales
Rugines a costales



Lambotte
21 cm



SS-16-169
5 mm



SS-16-170
10 mm



SS-16-171
15 mm



SS-16-172
20 mm



SS-16-173
25 mm



Matson
SS-16-174
22 mm / 8³/₄"

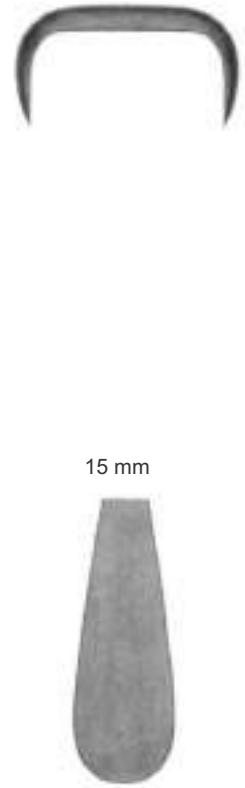

15 mm



Alexander-Farabeuf
SS-16-175
15 cm / 6"



10 mm



14 mm



12 mm



24 mm

Alexander-Farabeuf
SS-16-176
21 mm / 8¹/₄"

Rib Spreaders
 Separadores costales
 Ecarteurs a cotes

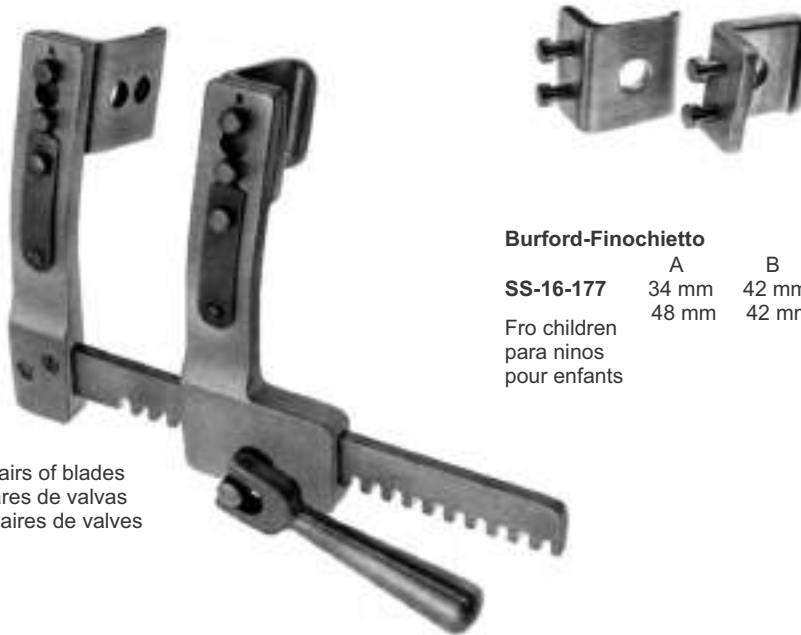

Burford-Finochietto

	A	B	C
SS-16-177	34 mm 48 mm	42 mm 42 mm	145 mm

For children
 para niños
 pour enfants

With 2 pairs of blades
 con 2 pares de valvas
 avec 2 paires de valves

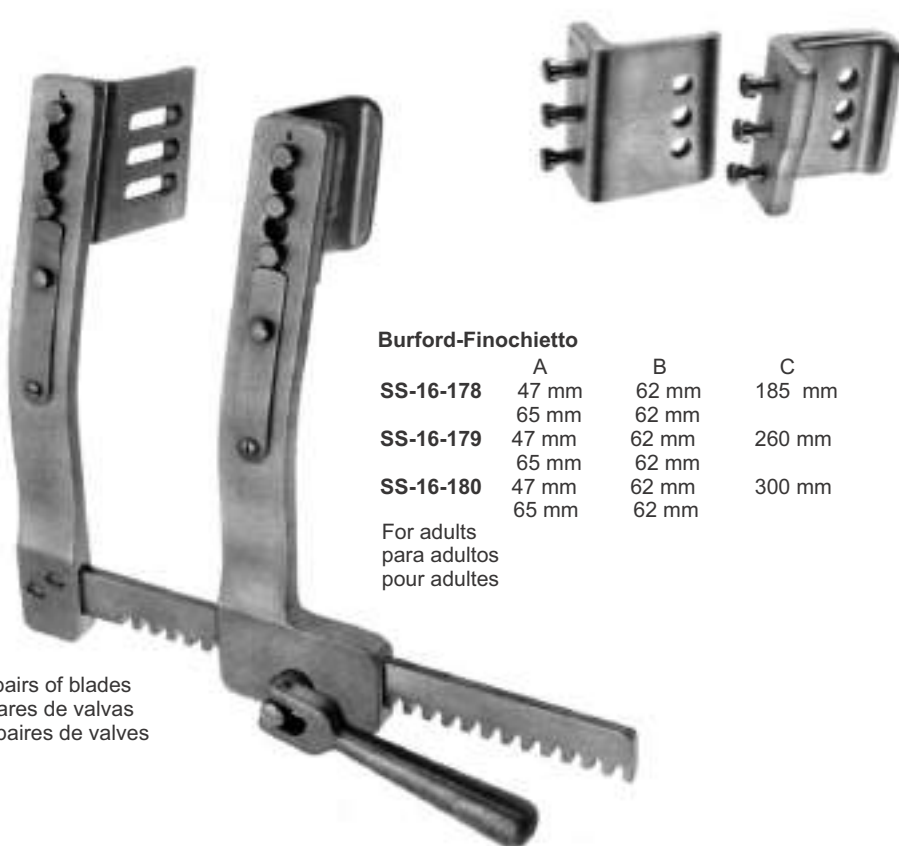

Burford-Finochietto

	A	B	C
SS-16-178	47 mm 65 mm	62 mm 62 mm	185 mm
SS-16-179	47 mm 65 mm	62 mm 62 mm	260 mm
SS-16-180	47 mm 65 mm	62 mm 62 mm	300 mm

For adults
 para adultos
 pour adultes

With 2 pairs of blades
 con 2 pares de valvas
 avec 2 paires de valves

Rib Spreaders Separadores costales Ecarteurs a cotes



Finochietto-Baby	A	B	C
SS-16-181	19 mm	20 mm	85 mm
Fro babies para bebes pour bebes			



Finochietto	A	B	C
SS-16-182	39 mm	45 mm	140 mm
SS-16-183	50 mm	66 mm	200 mm
SS-16-184	50 mm	66 mm	250 mm
SS-16-185	68 mm	66 mm	200 mm
SS-16-186	68 mm	66 mm	250 mm
SS-16-187	68 mm	66 mm	300 mm
For adults para adultos pour adultes			

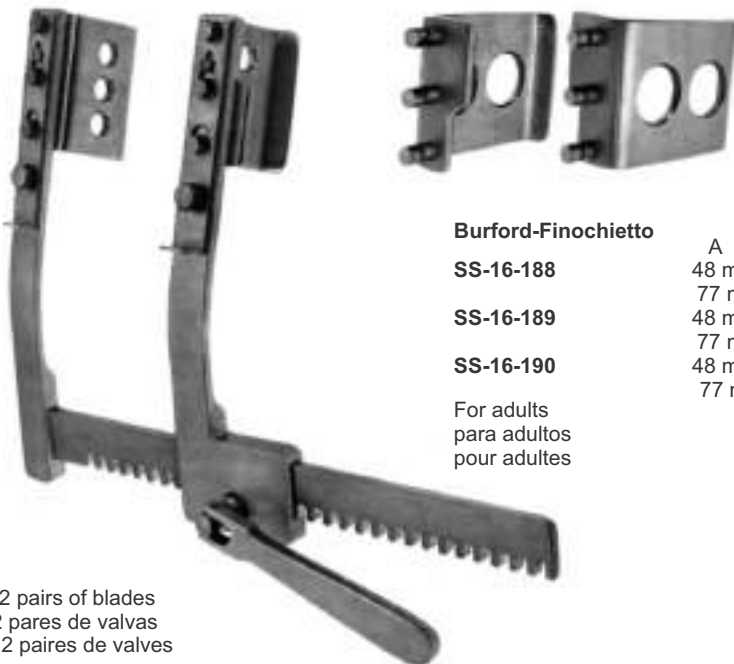

Burford-Finochietto	A	B	C
SS-16-188	48 mm 77 mm	64 mm 64 mm	210 mm
SS-16-189	48 mm 77 mm	64 mm 64 mm	260 mm
SS-16-190	48 mm 77 mm	64 mm 64 mm	300 mm
For adults para adultos pour adultes			

With 2 pairs of blades
con 2 pares de valvas
avec 2 paires de valves



SAPTESTAR
Manufacturer & Exporter Of Surgical, Dental & Veterinary Instruments

Rib Spreaders
Separadores costales
Ecarteurs a cotes



Chevalier
SS-16-191
Rib Spreaders
Separador costal
Ecarteur a cotes

A
27 mm

B
100 mm

C
190 mm

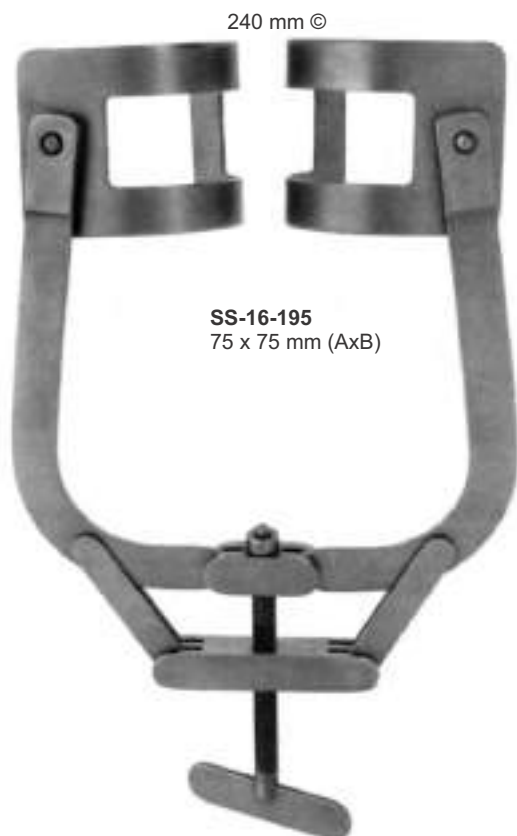

SS-16-195
75 x 75 mm (AxB)



SS-16-194
48 x 65 mm (AxB)

Mercedes
SS-16-192

Thoracic retractor, complete, consisting of:

- SS-16-193** 1 Spreader
- SS-16-194** 2 Lateral blades 48 x 65 mm (AxB)
- SS-16-195** 2 Lateral blades 75 x 75 mm (AxB)

Separador toracico, completo, compuesto de:

- SS-16-193** 1 Separador
- SS-16-194** 2 Valvas Laterales 48 x 65 mm (AxB)
- SS-16-195** 2 Valvas Laterales 75 x 75 mm (AxB)

Ecarteur thoracique, complet, compose de:

- SS-16-193** 1 Ecarteur
- SS-16-194** 2 Valvas Laterales 48 x 65 mm (AxB)
- SS-16-195** 2 Valvas Laterales 75 x 75 mm (AxB)



45 x 48 mm (AxB)

Cooley
SS-16-196
25 cm / 10"
right
derecho
droite



45 x 48 mm (AxB)

Cooley
SS-16-197
25 cm / 10"
right, serrated
derecho, estriado
droite, cannele



24 x 48 mm (AxB)

Cooley
SS-16-198
27.5 cm / 10¾"
left
izquierdo
gauche

Atrium Retractors
 Separadores atrium
 Ecarteurs atrium



Cooley
 13 cm / 5 1/8"

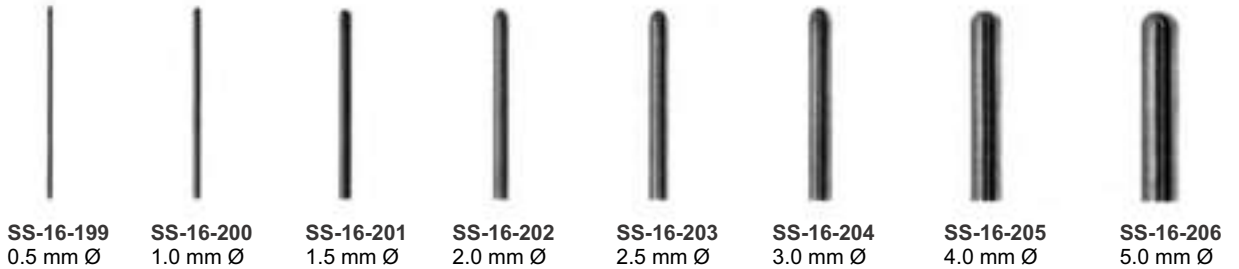

SS-16-199
 0.5 mm Ø

SS-16-200
 1.0 mm Ø

SS-16-201
 1.5 mm Ø

SS-16-202
 2.0 mm Ø

SS-16-203
 2.5 mm Ø

SS-16-204
 3.0 mm Ø

SS-16-205
 4.0 mm Ø

SS-16-206
 5.0 mm Ø

Malleable
 maleable
 malleables



**De Bakey
 (Garrett)**
 19 cm / 7 1/2"

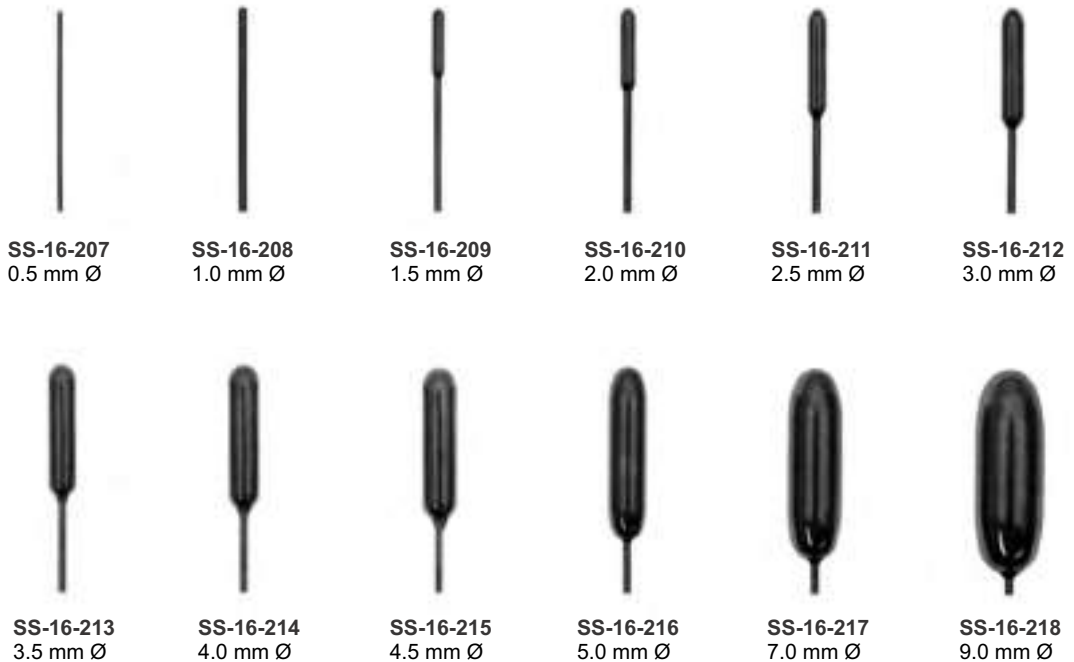

SS-16-207
 0.5 mm Ø

SS-16-208
 1.0 mm Ø

SS-16-209
 1.5 mm Ø

SS-16-210
 2.0 mm Ø

SS-16-211
 2.5 mm Ø

SS-16-212
 3.0 mm Ø

SS-16-213
 3.5 mm Ø

SS-16-214
 4.0 mm Ø

SS-16-215
 4.5 mm Ø

SS-16-216
 5.0 mm Ø

SS-16-217
 7.0 mm Ø

SS-16-218
 9.0 mm Ø

Malleable
 maleable
 malleables

Bulldog Clamps
 Clamps Bulldog
 Clamps Bulldog



**De Bakey
 SS-16-219**
 13 cm / 5 1/8"



**De Bakey
 SS-16-220**
 12.5 cm / 5"



**De Bakey
 SS-16-221**
 10 cm / 4"



**De Bakey
 SS-16-222**
 12.5 cm / 5"



**De Bakey
 SS-16-223**
 12.5 cm / 5"

Vascular Clamps
 Pinzas-clamps
 Pincas vasculares



De Bakey-Pean

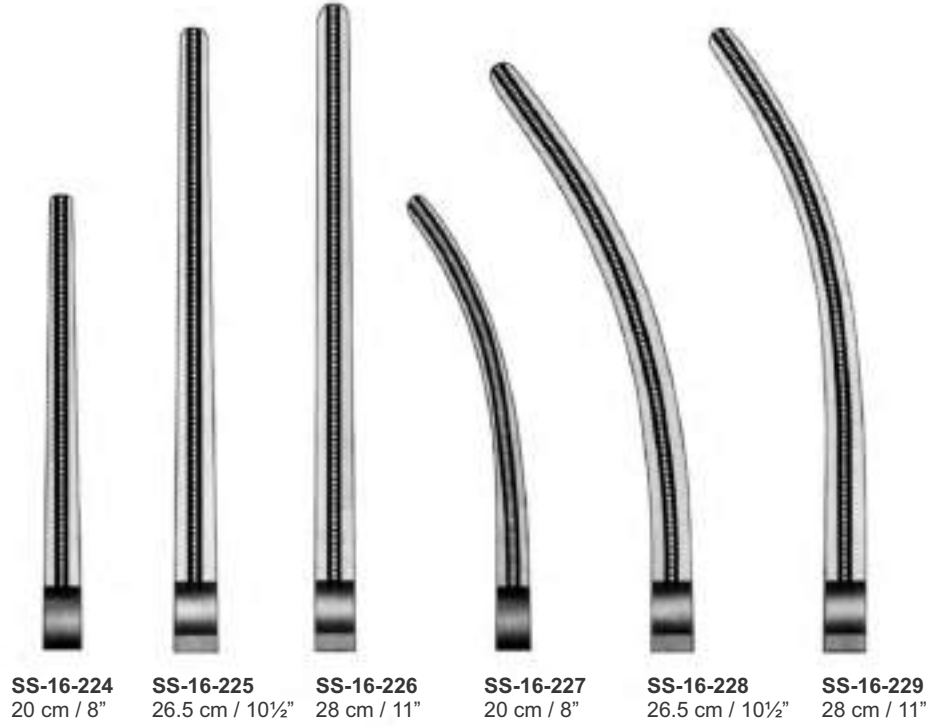

De Bakey

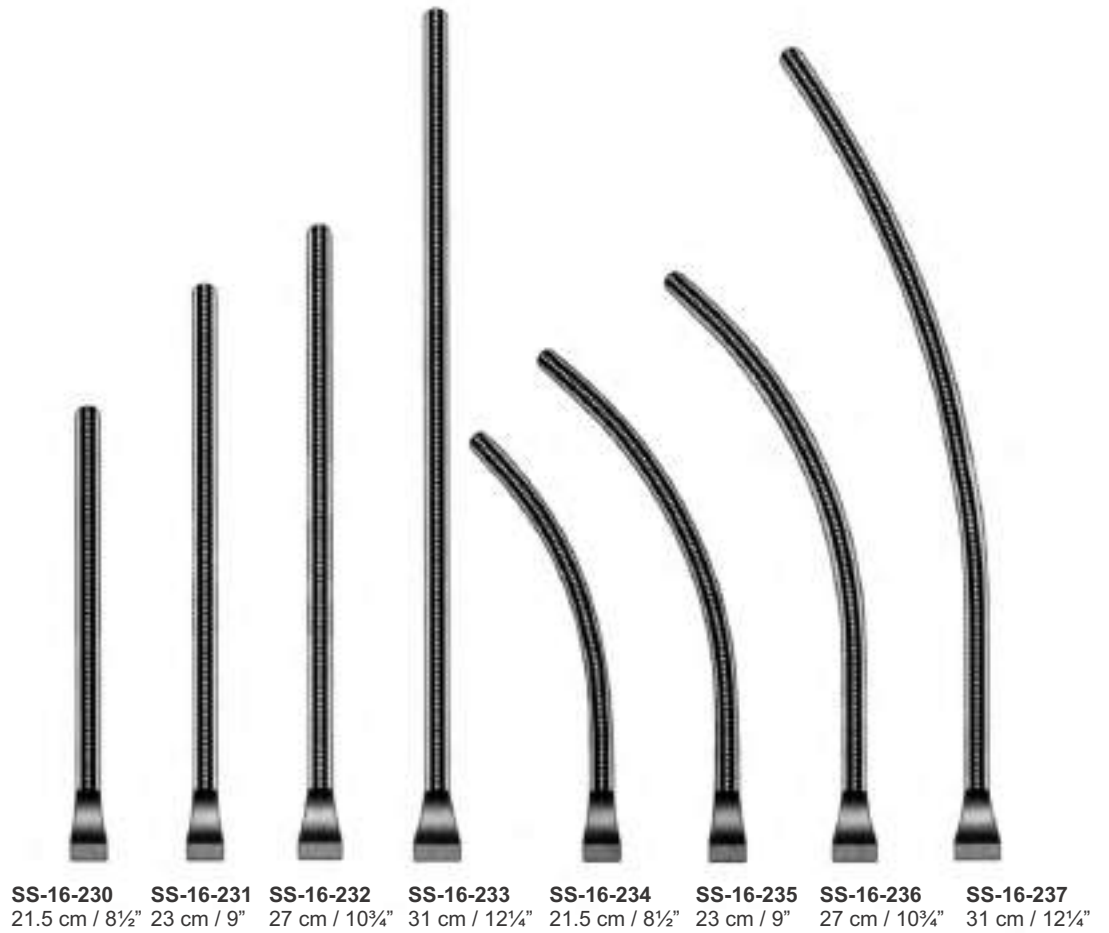

Vascular Clamps
 Pinzas-clamps
 Pincas vasculares



De Bakey-Bainbridge



SS-16-238
 15 cm / 6"



SS-16-239
 18.5 cm / 7 1/4"



De Bakey-Bainbridge



SS-16-240
 15 cm / 6"



SS-16-241
 18.5 cm / 7 1/4"



De Bakey



SS-16-242
 16 cm / 6 1/4"



SS-16-243
 15.5 cm / 6 1/4"



SS-16-244
 14 cm / 5 1/2"

Multi-purpose clamps
 Pinzas-clamps de varias aplicaciones
 Pincas-clamps universelles



SAPTESTAR
Manufacturer & Exporter Of Surgical, Dental & Veterinary Instruments

Patent Ductus Clamps
Pinzas Pantent de conducto
Clamps patent-ductus



SS-16-245
15.5 cm / 6"

De Bakey



SS-16-246
19.5 cm / 7³/₄"



De Bakey



SS-16-247
15 cm / 6"



SS-16-248
19 cm / 7¹/₂"



De Bakey-Potts
SS-16-249
20.5 cm / 8"



De Bakey-Potts
SS-16-250
20 cm / 8"



Patent Ductus Clamps
Pinzas Pantent de conducto
Clamps patent-ductus



De Bakey
SS-16-252
16.5 cm / 6½"



De Bakey
SS-16-253
16 cm / 6¼"



De Bakey
SS-16-254
17 cm / 6¾"



De Bakey
SS-16-255
17 cm / 6¾"



SAPTESTAR
Manufacturer & Exporter Of Surgical, Dental & Veterinary Instruments

Patent Ductus Clamps
Pinzas Pantent de conducto
Clamps patent-ductus



De Bakey



SS-16-256
20.5 cm / 8"



SS-16-257
22.5 cm / 9"



SS-16-258
26 cm / 10½"



De Bakey



SS-16-259
20 cm / 8"



SS-16-260
22 cm / 8¾"



SS-16-261
25.5 cm / 10"

Vascular Clamps
Pinzas-clamps vasculares
Pinces vasculaires



Gregory

SS-16-262
14 cm / 5½"



SS-16-263
16 cm / 6¼"



SS-16-264
18 cm / 7"



Profunda clamps
Pinzas-clamps para la Profunda
Pinces-clamps pour femorale



Leland-jones

SS-16-265
19 cm / 7½"



SS-16-266
18.5 cm / 7¼"



De Bakey
SS-16-267
18 cm / 7"

Peripheral vascular clamps
Pinzas-clamps para vasos perifericos
Pinces-clamps vasculaires peripheriques

Peripheral Vascular Clamps
 Pinzas-clamps para vasos perifericos
 Pincas-clamps vasculaires peripheriques



De Bakey
SS-16-268
 15.5 cm / 6"



De Bakey



SS-16-269
 20 cm / 8"



SS-16-270
 19 cm / 7½"



Dale



SS-16-271
 17 cm / 6¾"



SS-16-272
 17.5 cm / 7"



SS-16-273
 18 cm / 7"



SS-16-274
 18.5 cm / 7¼"

Peripheral Vascular Clamps
 Pinzas-clamps para vasos perifericos
 Pinces-clamps vasculaires peripheriques



De Bakey
SS-16-275
 15 cm / 6"



De Bakey
SS-16-276
 16.5 cm / 6½"



De Bakey
SS-16-277
 18 cm / 7"

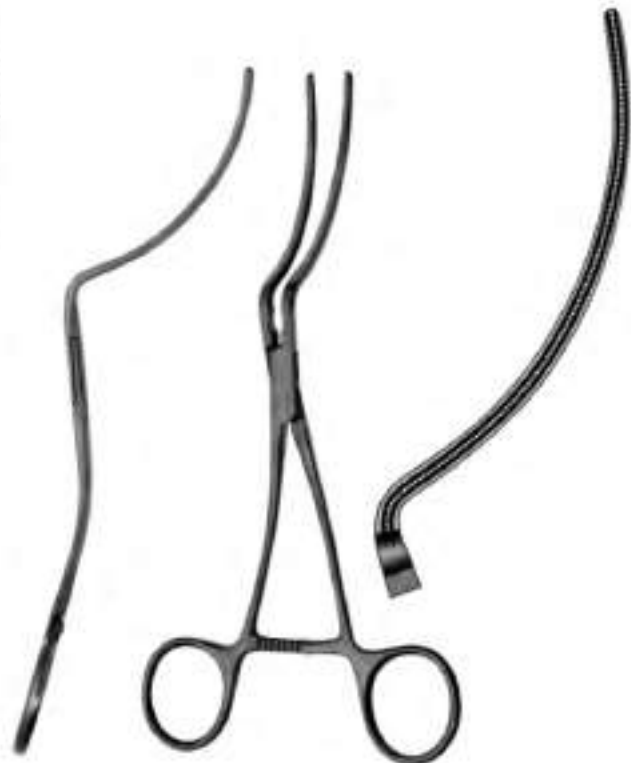

De Bakey
SS-16-278
 19 cm / 7½"

Vascular Clamps
 Pinzas-clamps Vasculares
 Pinces vasculaires



De Bakey
SS-16-279
 20 cm / 8"
 Renal artery clamp
 Pinza-clamp para arteria renal
 Pince hemostatique renale



Javid
SS-16-280
 18 cm / 7"
 Carotid clamp
 Pinza-clamp para carotida
 Pince-clamp pour la carotide



Javid
SS-16-281
 19 cm / 7½"
 Carotid clamp
 Pinza-clamp para carotida
 Pince-clamp pour la carotide



Subramanian
SS-16-282
 15.5 cm / 6"



Subramanian
SS-16-283
 15.5 cm / 6"
 Aortic clamp
 pinzas-clamps para aorta



De Bakey-Beck
SS-16-284
 16 cm / 6¼"

Aortic clamps
 Pinzas-clamps
 Pinces-clamps



Bailey



Bailey



Bailey

Aortic Clamps
Pinzas-clamps
Pinces-clamps

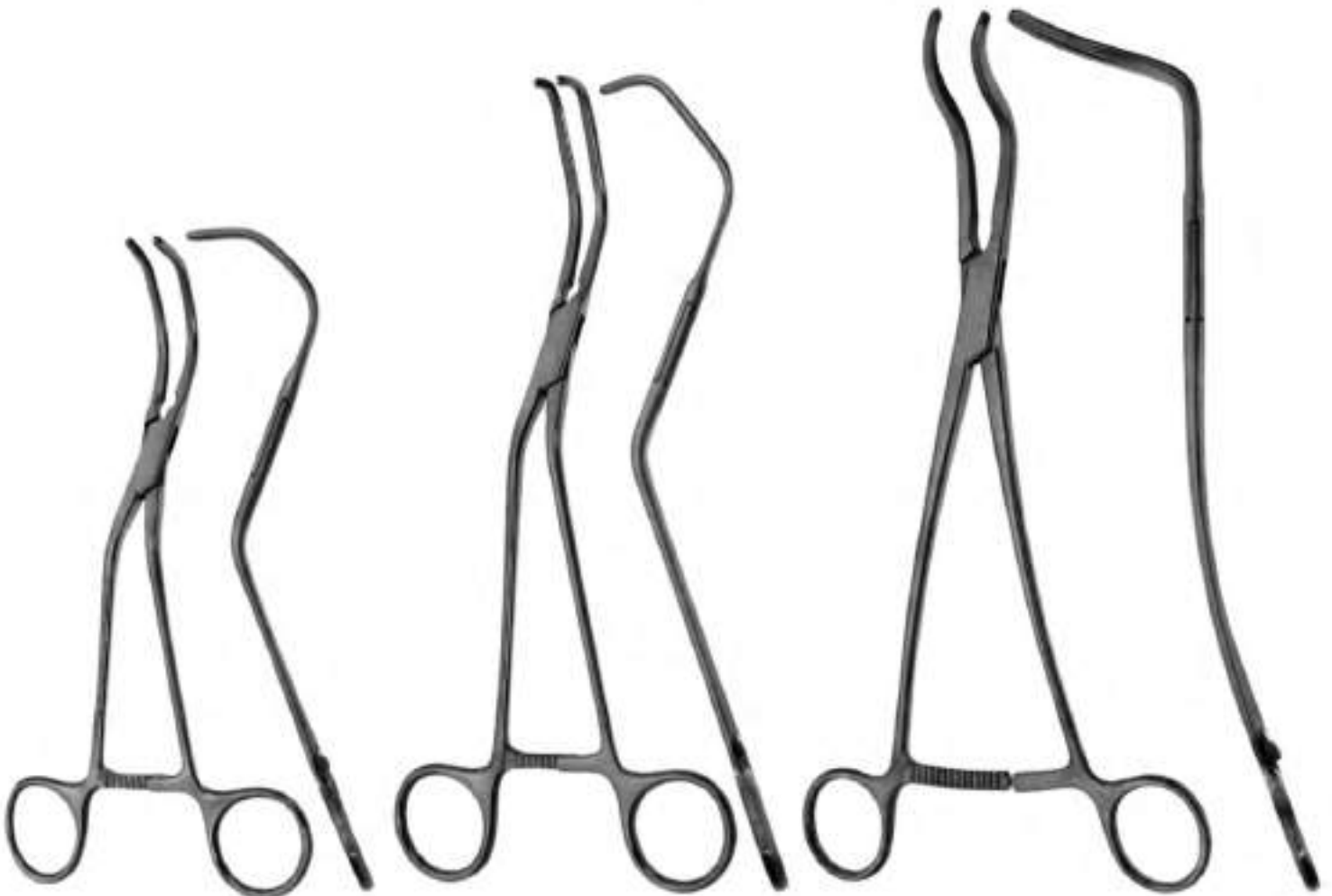

Dietrich
SS-16-293
19.5 cm / 7 ¾"

Ochsner
SS-16-294
24 cm / 9 ½"

De Bakey
SS-16-295
26 cm / 10 ¼"

Aortic Clamps
 Pinzas-clamps
 Pinces-clamps



SS-16-296
 22.5 cm / 9"



SS-16-298
 27.5 cm / 10 3/4"



SS-16-297
 18 cm / 7"



SS-16-299
 23 cm / 9"



De Bakey-Morris



De Bakey-Morris

Tangential Occlusion Clamps
 Pinzas-clamps para oclusion tangencial
 Pincas vasculaires pour oclusion tangencielle



Anastomosis Clamps
 Pinzas-clamps para anastomosis
 Pinces-clamps a anastomose



De Bakey-Reynolds



SS-16-310
 16.5 cm / 6 1/2"

SS-16-311
 16.5 cm / 6 1/2"

SS-16-312
 17.5 cm / 7"

SS-16-313
 17.5 cm / 7"



De Bakey-Derra



SS-16-314
 16.5 cm / 6 1/2"

SS-16-315
 16.5 cm / 6 1/2"

SS-16-316
 17 cm / 6 3/4"



SAPTESTAR
Manufacturer & Exporter Of Surgical, Dental & Veterinary Instruments

Anastomosis Clamps
Pinzas-clamps para anastomosis
Pinces-clamp a anastomose



Glover

SS-16-317
20.5 cm / 8"



SS-16-318
24.5 cm / 9 3/4"



Glover

SS-16-319
21 cm / 8 1/4"



SS-16-320
25.5 cm / 10"



Glover



SS-16-321
18 cm / 7"



SS-16-322
22 cm / 8 3/4"

Anastomosis Clamps
 Pinzas-clamps para anastomosis
 Pinces-clamps a anastomose



De Bakey
SS-16-323
 17 cm / 6 3/4"



De Bakey-Beck

SS-16-324
 15 cm / 6"



SS-16-325
 15 cm / 6"



De Bakey



SS-16-327
 16 cm / 6 1/4"

SS-16-328
 16 cm / 6 1/4"

SS-16-326
 16 cm / 6 1/4"



SAPTESTAR
Manufacturer & Exporter Of Surgical, Dental & Veterinary Instruments

Aorta-Aneurysma Clamps
Pinzas-clamps para aneurisma
Pinces-clamps pour aneurisme

For temporary occlusion of the arteria iliaca
para la oclusion temporal de la arteria iliac
pour oclusion temporele de l'artere illiaque

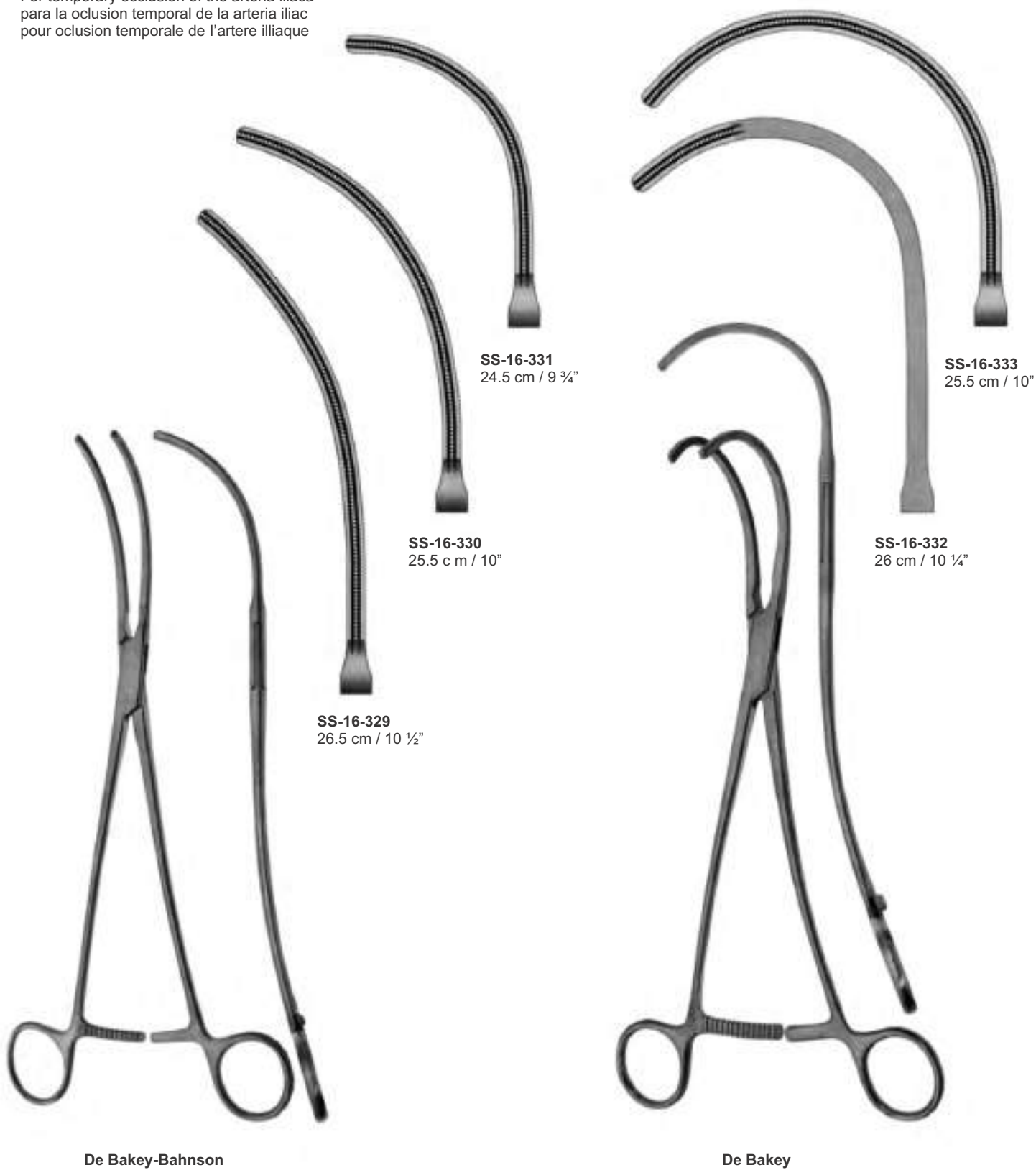

Aorta-Aneurysma Clamps
 Pinzas-clamps para aneurisma
 Pinces-clamps pour aneurisme

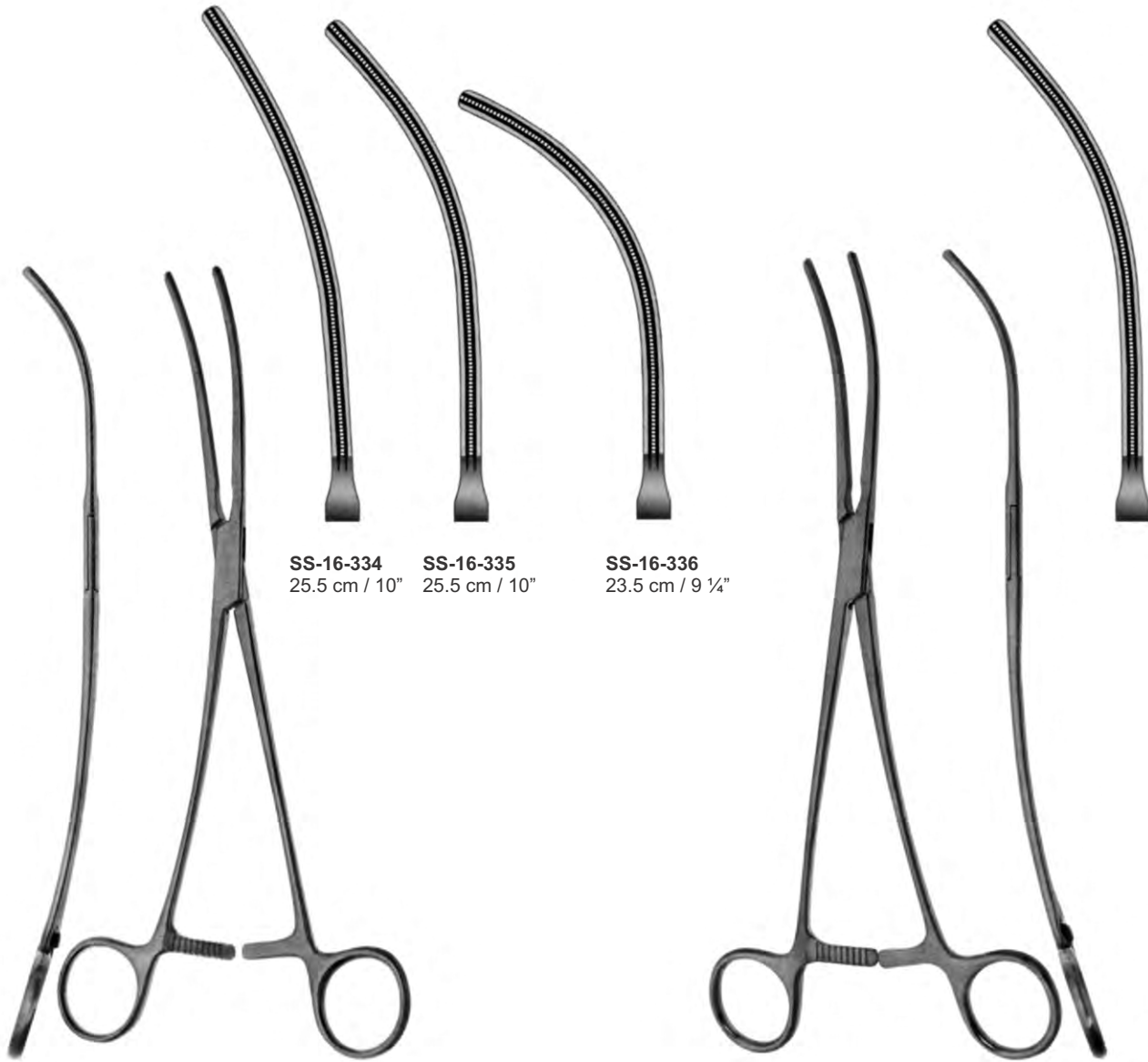

SS-16-334
 25.5 cm / 10"

SS-16-335
 25.5 cm / 10"

SS-16-336
 23.5 cm / 9 1/4"

De Bakey-Crafoord

De Bakey-Crafoord
SS-16-337
 26 cm / 10 1/4"



SAPTESTAR
Manufacturer & Exporter Of Surgical, Dental & Veterinary Instruments

Aorta-Aneurysma Clamps
Pinzas-clamps para aneurisma
Pinces-clamps pour aneurisme



SS-16-338 **SS-16-339** **SS-16-340** **SS-16-341**
26 cm / 10 ¼" 26.5 cm / 10 ½" 31 cm / 12 ¼" 33 cm / 13"

De Bakey

De Bakey
SS-16-342
30.5 cm / 12"

Aorta-Aneurysma Clamps
Pinzas-clamps para aneurisma
Pinces-clamps pour aneurisme



Weber
SS-16-343
25 cm / 10"
left
izquierda
a gauche



Weber
SS-16-344
25 cm / 10"
right
derecha
a droite

Aorta-Aneurysma Clamps
Pinzas-clamps para aneurisma
Pinces-clamps pour aneurisme



Lambert-Kay



B-16-345
19.5 cm / 7 3/4"



SS-16-346
20 cm / 8"



Wylie



SS-16-347
22.5 cm / 9"



SS-16-348
23 cm / 9"

Vena-Cava Clamps
Pinzas-clamps para vena cava
Pinces-clamps pour veine cave



SS-16-349
19 cm / 7 ½"

SS-16-350
21 cm / 8 ¼"



Calne
SS-16-351
27 cm / 10 ¾"

The special clamp makes it possible to clamp the vena cava interior above the liver according to the anatomic condition. The lock at the upper end of the jaws fixes firmly the part of the jaws of the clamp after it is placed. Thus impeding the vena cava interior -clamped together with diaphragm- from slipping out.

Se facilita la colocacion amoldada de la vena cava interior sobre el higado, por causa de la forma anatomica de la pinza clamp especial. El cierre a la punta de la mandibula sujeta firmemente la pinza clamp y evita que se escape la vana cava interior con el diafragma.

Le clamp special permet un clampage atraumatique de la veine cave interieure au-dessus du foie, adapte aux conditions anatomiques. L'anneau terminal permet de maintenir les mors joints evitant ainsi le glisse-ment de la veine cave superieure clampee avec le diaphragme.



SAPTESTAR
Manufacturer & Exporter Of Surgical, Dental & Veterinary Instruments

Disecting & Ligature Forceps
Pinzas para diseccion y ligaduras
Pincas a dissequer et a ligatures

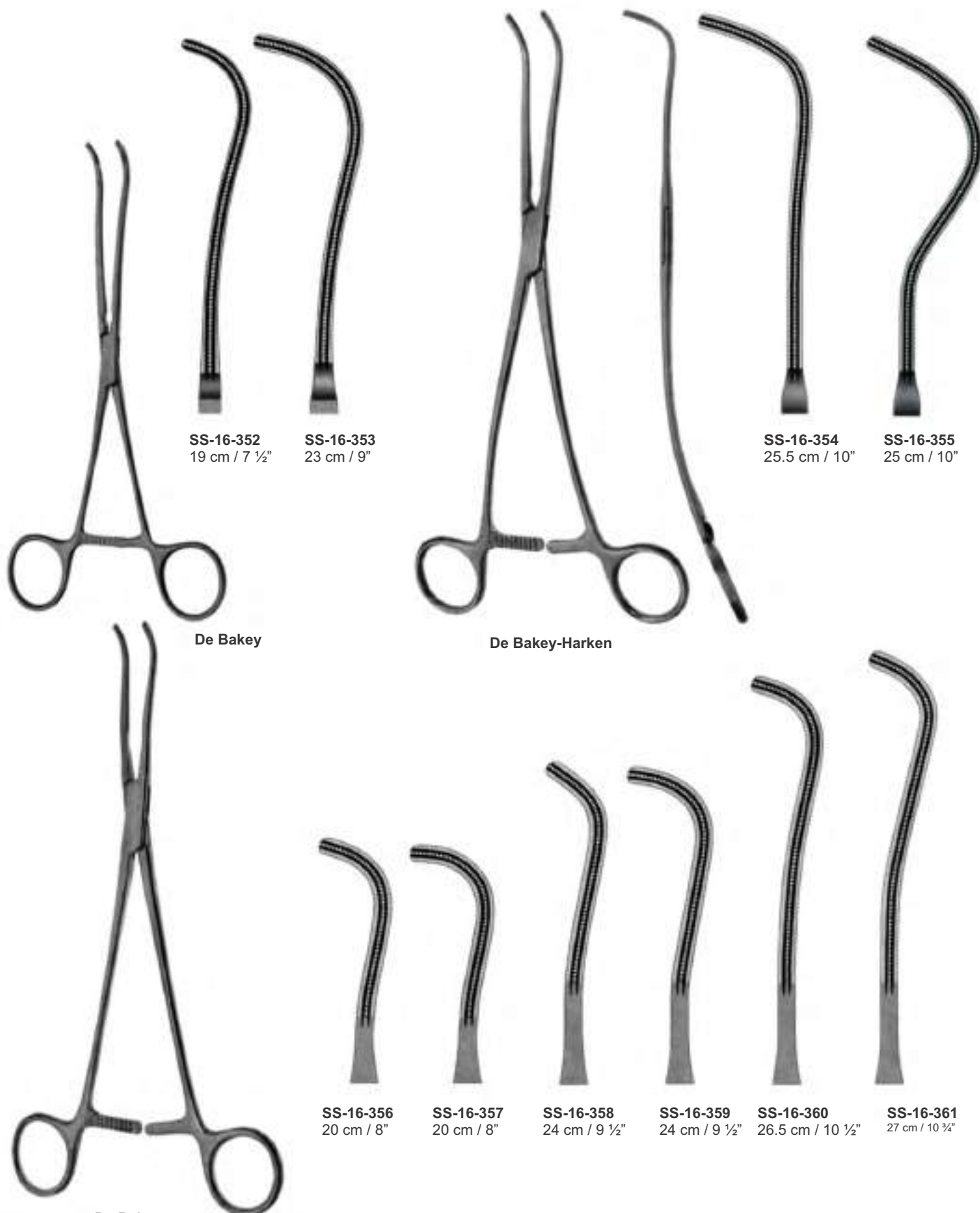

SS-16-352
19 cm / 7 ½"

SS-16-353
23 cm / 9"

SS-16-354
25.5 cm / 10"

SS-16-355
25 cm / 10"

De Bakey

De Bakey-Harken

SS-16-356
20 cm / 8"

SS-16-357
20 cm / 8"

SS-16-358
24 cm / 9 ½"

SS-16-359
24 cm / 9 ½"

SS-16-360
26.5 cm / 10 ½"

SS-16-361
27 cm / 10 ¾"

Bronchus Clamps
Pinzas-clamps bronquiales
Pinces-clamps a bronches



Lees
SS-16-362
21 cm / 8 1/4"



Lees
SS-16-363
22 cm / 8 3/4"



Lees
SS-16-364
24.5 cm / 9 3/4"

Multi-Purpose Clamps
 Pinzas-clamps de varis aplicaciones
 Pinces-clamps universelles



De Bakey

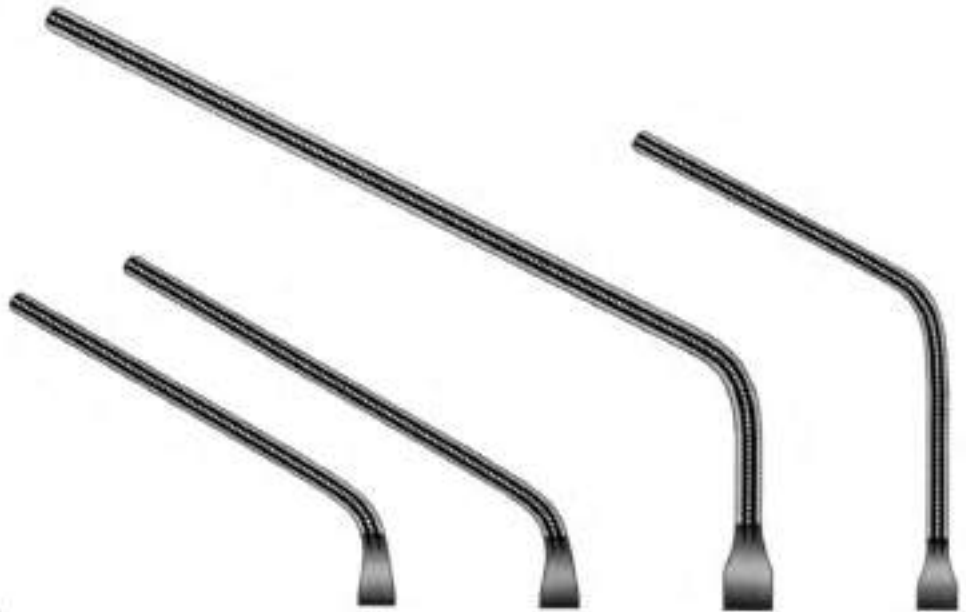

SS-16-365
 20 cm / 8"

SS-16-366
 23.5 cm / 9 1/4"

SS-16-367
 30.5 cm / 12"

SS-16-368
 24 cm / 9 1/2"



De Bakey

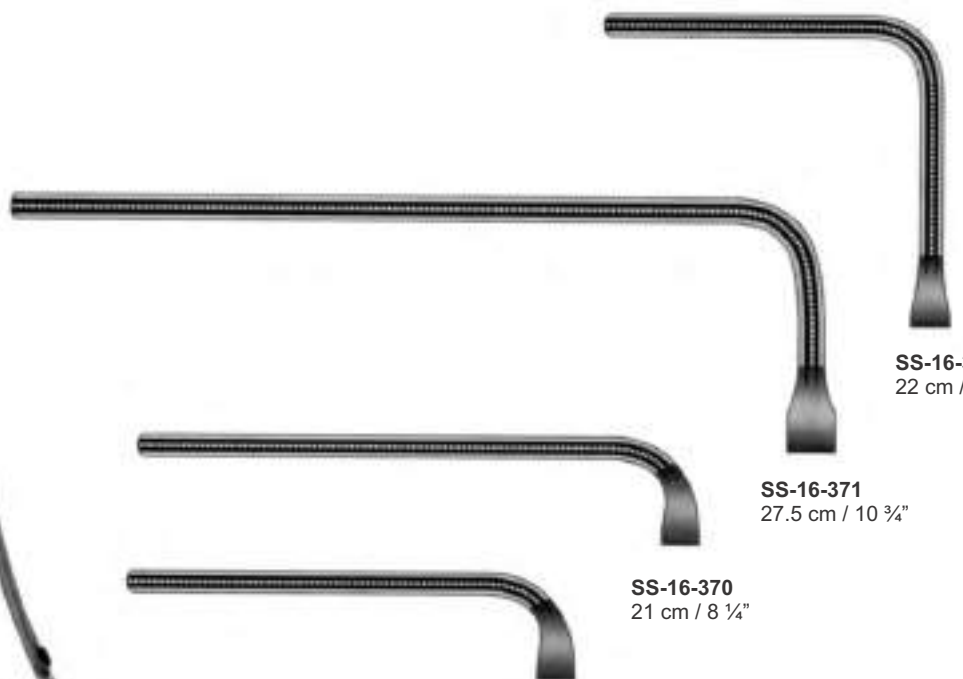

SS-16-372
 22 cm / 8 3/4"

SS-16-371
 27.5 cm / 10 3/4"

SS-16-370
 21 cm / 8 1/4"

SS-16-369
 18.5 cm / 7 1/4"

Multi-Purpose Clamps
Pinzas-clamp de varis aplicaciones
Pinces-clamp universelles



SS-16-373
15 cm / 6"



15°
SS-16-374
15 cm / 6"



30°
SS-16-375
15 cm / 6"



45°
SS-16-376
14.5 cm / 5 ¾"



90°
SS-16-377
13 cm / 5 ⅛"



SS-16-378
16.5 cm / 6 ½"



15°
SS-16-379
16.5 cm / 6 ½"



30°
SS-16-380
16 cm / 6 ¼"



45°
SS-16-381
16 cm / 6 ¼"



90°
SS-16-382
13.5 cm / 5 ¼"



Dardik

Vascular Clamps
 Pinzas-clamps vasculares
 Pincas vasculaires

For pediatric surgery. Para la pediatria. Pour chirurgie pediatrique



SS-16-383
 14 cm / 5 1/2"

Cooley



BC-16-384
 14 cm / 5 1/2"



Cooley



SS-16-385
 11.5 cm / 4 1/2"



SS-16-386
 11.5 cm / 4 1/2"



SS-16-387
 11.5 cm / 4 1/2"



Cooley
SS-16-388
 14 cm / 5 1/2"



Cooley
SS-16-389
 13.5 cm / 5 1/4"



Cooley
SS-16-390
 13.5 cm / 5 1/4"

Blood Vessel Clamps
Pinzas-clamps para vasos
Pinces vasculaires



Cooley
SS-16-391
12.5 cm / 5"
Bulldog clamp
Clamp Bulldog
Clamp Bulldog



Cooley
SS-16-392
12.5 cm / 5"
Bulldog clamp
Clamp Bulldog
Clamp Bulldog



Cooley
SS-16-393
15.5 cm / 6"
Patent ductus clamp
Pinzas patente de conducto
Clamp patent-ductus droit



Cooley
SS-16-394
15 cm / 6"
Patent ductus clamp
Pinzas patente de conducto
Clamp patent-ductus droit



Cooley



SS-16-395
16 cm / 6 1/4"



SS-16-396
15.5 cm / 6"



SS-16-397
14 cm / 5 1/2"

Multi-purpose clamps. Pinzas-clamps de varias aplicaciones. Pinces-clamp universelles



SAPTESTAR
Manufacturer & Exporter Of Surgical, Dental & Veterinary Instruments

Coarctation Clamps
Pinzas-clamps para coarctacion
Pinces-clamps pour coarctation



Cooley
SS-16-398
16.5 cm / 6 1/2"



Cooley
SS-16-399
16 cm / 6 1/4"



Cooley
SS-16-400
17 cm / 6 3/4"



Cooley
SS-16-401
17 cm / 6 3/4"



SS-16-402
19.5 cm / 7 3/4"



SS-16-403
22.5 cm / 9"



SS-16-404
19 cm / 7 1/2"



SS-16-405
22 cm / 8 3/4"

Cooley

Cooley

Vascular Clamps
Pinzas-clamps vasculares
Pinces vasculaires



Cooley
SS-16-406
18 cm / 7"
Peripheral vascular clamp
Pinza-clamp para vasos perifericos
Pince-clamp peripherique



Cooley
Iliac clamp
Pinzas-clamp para iliaca
Pinces-clamps iliques

SS-16-407
21 cm / 8 1/4"



SS-16-408
27 cm / 10 3/4"



Cooley



SS-16-409
18.5 cm / 7 1/4"



SS-16-410
19.5 cm / 7 3/4"



SS-16-411
27.5 cm / 10 3/4"

Renal artery clamp, also used for subclavian and carotid artery
Pinzas-clamps para las arterias renales, tambien se usan para la ateria clavicular y carotide
Pinces hemostatiques renales, egalement utilisees pour L' artere clavulaire et la carotide



SAPTESTAR
Manufacturer & Exporter Of Surgical, Dental & Veterinary Instruments

Anastomosis Clamps
Pinzas-clamps para anastomosis
Pinces-clamps a anastomose



Cooley-Reynolds



SS-16-412
16.5 cm / 6 1/2"



SS-16-413
16.5 cm / 6 1/2"



SS-16-414
17.5 cm / 7"



SS-16-415
17.5 cm / 7"



Cooley-Derra



SS-16-416
16.5 cm / 6 1/2"



SS-16-417
16.5 cm / 6 1/2"



SS-16-418
17 cm / 6 3/4"

Anastomosis Clamps
 Pinzas-clamps para anastomosis
 Pinces-clamps a anastomose



Cooley
SS-16-419
 17 cm / 6 3/4"

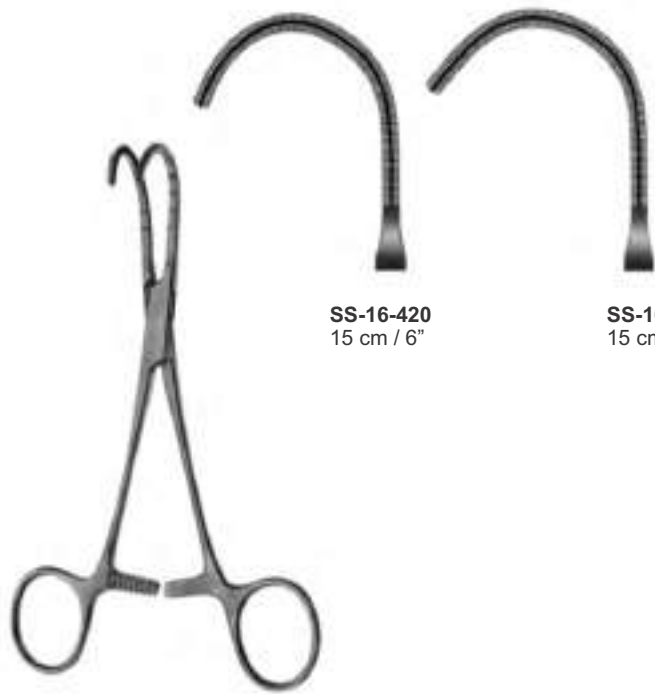

SS-16-420
 15 cm / 6"

SS-16-421
 15 cm / 6"

Cooley-Beck



Cooley



SS-16-423
 16 cm / 6 1/4"

SS-16-424
 16 cm / 6 1/4"

SS-16-422
 16 cm / 6 1/4"

Vascular Clamps
Pinzas-clamps vasculares
Pinces vasculaires



Cooley
SS-16-425
26.5 cm / 10 1/2"
Aortic aneurysm clamp
Pinzas-clamp para aneurisma de aorta
Pince-clamp pour aneurisme de l'aorte



Cooley
SS-16-426
25 cm / 10"
Aortic clamps
Pinza-clamp para aorta
Pince-clamp pour aorte

Vascular Clamps
Pinzas-clamp vasculares
Pinces vasculaires



SS-16-427
19 cm / 7 1/2"

SS-16-228
25.5 cm / 10"

SS-16-429
27 cm / 10 3/4"

Tangential occlusion clamps
Pinzas-clamps para oclusion tangencial
Pinces-clamps pour oclusion tangentielle



SS-16-430
20 cm / 8"

SS-16-431
23.5 cm / 9 1/4"

Multi-Purpose clamps
Pinzas-clamps de varias aplicaciones
Pinces-clamps universelles



SAPTESTAR
Manufacturer & Exporter Of Surgical, Dental & Veterinary Instruments

Disecting Ligature Forceps
Pinzas de diseccion y ligaduras
Pinces a dissequer et a ligatures



SS-16-438
24 cm / 9 1/2"



SS-16-439
24 cm / 9 1/2"



Finochietto
SS-16-440
24 cm / 9 1/2"
Thoracic and ligature forceps
Pinzas de toracica y ligadura
Pince thoracique et pour ligatures

Semb
Dissecting and ligature forceps
Pinzas de diseccion y ligaduras
Pinces a dissequer et a ligatures



SS-16-441
24 cm / 9 1/2"



SS-16-442
24 cm / 9 1/2"



SS-16-443
24 cm / 9 1/2"



Crafoord
Auricle clamps
Pinzas para la auricula atri
Pinces-clamps auriculaires

Anastomosis (Vena Cava) Clamps
 Pinzas-clamps para anastomosis (vena cava)
 Pinces-clamps a anastomose (veine cave)



SS-16-446
 20.5 cm / 8"

SS-16-447
 27 cm / 10 3/4"



Baby-Satinsky
SS-16-444
 16 cm / 6 1/4"



Satinsky
SS-16-445
 24 cm / 9 1/2"



Satinsky

Bronchus Forceps
Pinzas-clamps bronquiales
Pinces-clamp a bronches



Price-Thomas
SS-16-448
22 cm / 8 3/4"



SS-16-449
22 cm / 8 3/4"



SS-16-450
22 cm / 8 3/4"

Price-Thomas
jaw with pins
con dientes
avec dents



Sarat
jaw with pins
con dientes
avec dents



SS-16-451
22.5 cm / 9"



SS-16-452
22.5 cm / 9"

Bulldog Clamps
Clamps Bulldog
Clamps Bulldog

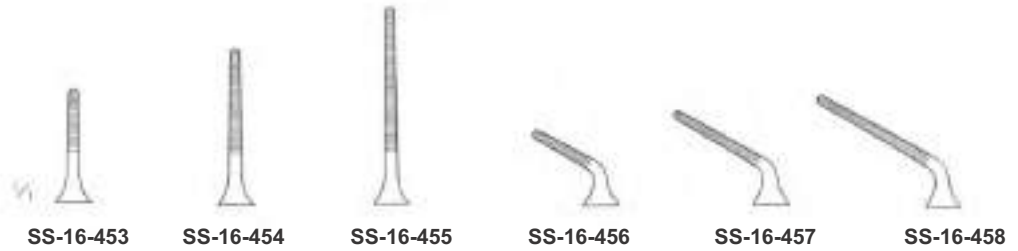

Diethrich

	SS-16-453	SS-16-454	SS-16-455	SS-16-456	SS-16-457	SS-16-458
Length longitud longueur	4.5 cm	4.55 cm	5 cm	4.5 cm	5 cm	6 cm
Jaw length longitud de la boca longeur des mors	8 mm	12 mm	20 mm	8 mm	12 mm	20 mm
Closing pressure presion de cierre pression d' occlusion	50 gr.	50 gr.	50 gr.	50 gr.	50 gr.	50 gr.
Weight peso poids	3 gr.	3 gr.	3 gr.	3 gr.	3 gr.	3 gr.

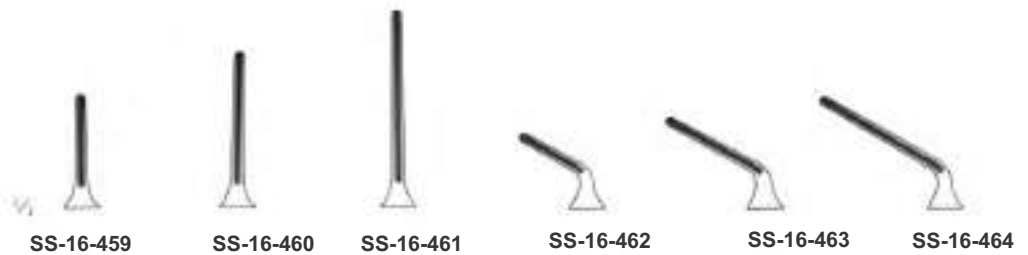

De Bakey-Diethrich

	SS-16-459	SS-16-460	SS-16-461	SS-16-462	SS-16-463	SS-16-464
Length longitud longueur	4.5 cm	5 cm	6 cm	3.5 cm	4.5 cm	6 cm
Jaw length longitud de la boca longeur des mors	10 mm	14 mm	20 mm	10 mm	14 mm	20 mm
Closing pressure presion de cierre pression d' occlusion	180 gr.	180 gr.	180 gr.	180 gr.	180 gr.	180 gr.
Weight peso poids	3 gr.	3 gr.	3 gr.	3 gr.	3 gr.	3 gr.

Bulldog Clamps
Clamps Bulldog
Clamps Bulldog



**Vena
SS-16-465**



**Vena
SS-16-466**



**Vena
SS-16-467**



**Vena
SS-16-468**

Closing pressure
presion de cierre
pression d' occlusion

110+/-10 gr.

110+/-10 gr.

110+/-10 gr.

110+/-10 gr.

**Arteria
SS-16-469**

**Arteria
SS-16-470**

**Arteria
SS-16-471**

**Arteria
SS-16-472**

Closing pressure
presion de cierre
pression d' occlusion

220+/- 10 gr.

220+/- 10 gr.

220+/- 10 gr.

220+/- 10 gr.

Length
longitud
longueur

30 mm

35 mm

40 mm

50 mm

Jaw length
longitud de la boca
longueur des mors

9 mm

13 mm

14 mm

23 mm

Weight
peso
poids

1 gr.

1 gr.

1 gr.

1.5 gr.



Bulldog Clamps
Clamps Bulldog
Clamps Bulldog



**Vena
SS-16-473**



**Vena
SS-16-474**



**Vena
SS-16-475**



**Vena
SS-16-476**

Closing pressure
pression de cierre
pression d'occlusion

110+/-10 gr.

110+/-10 gr.

110+/-10 gr.

110+/-10 gr.

**Arteria
SS-16-477**

**Arteria
SS-16-478**

**Arteria
SS-16-479**

**Arteria
SS-16-480**

Closing pressure
pression de cierre
pression d'occlusion

220+/-10 gr.

220+/-10 gr.

220+/-10 gr.

220+/-10 gr.

30 mm

35 mm

40 mm

50 mm

Jaw length
longitud de la boca
longueur des mors

9 mm

13 mm

14 mm

23 mm

Weight
peso
poids

1 gr.

1 gr.

1 gr.

1.5 gr.



**Vena
SS-16-481**



**Vena
SS-16-482**



**Vena
SS-16-483**



**Vena
SS-16-484**

Closing pressure
pression de cierre
pression d'occlusion

110+/-10 gr.

110+/-10 gr.

110+/-10 gr.

110+/-10 gr.

**Arteria
SS-16-485**

**Arteria
SS-16-486**

**Arteria
SS-16-487**

**Arteria
SS-16-488**

Closing pressure
pression de cierre
pression d'occlusion

220+/-10 gr.

220+/-10 gr.

220+/-10 gr.

220+/-10 gr.

30 mm

35 mm

40 mm

50 mm

Jaw length
longitud de la boca
longueur des mors

10 mm

14 mm

15 mm

21 mm

Weight
peso
poids

1 gr.

1 gr.

1 gr.

1.5 gr.



SAPTESTAR
Manufacturer & Exporter Of Surgical, Dental & Veterinary Instruments

Carotid Shunt Clamps, Catheter Clamps
Pinzas para shunt carotido, Pinzas para cateteres
Pinces pour carotide, Pinces pour sondes



SS-16-491
16 cm / 6 1/4"
24 Charr.



SS-16-492
16 cm / 6 1/4"
26 Charr.



SS-16-493
20 cm / 8"
28 Charr.



SS-16-494
20 cm / 8"
30 Charr.



SS-16-495
20 cm / 8"
32 Charr.



SS-16-496
20 cm / 8"
36 Charr.

Catheter Clamps
Pinzas para cateteres
Pinces pour sondes

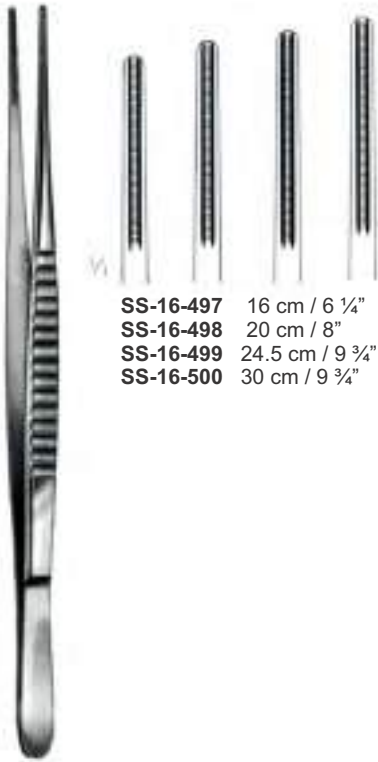

SS-16-497 16 cm / 6 1/4"
SS-16-498 20 cm / 8"
SS-16-499 24.5 cm / 9 3/4"
SS-16-500 30 cm / 9 3/4"

De Bakery
2.7 mm

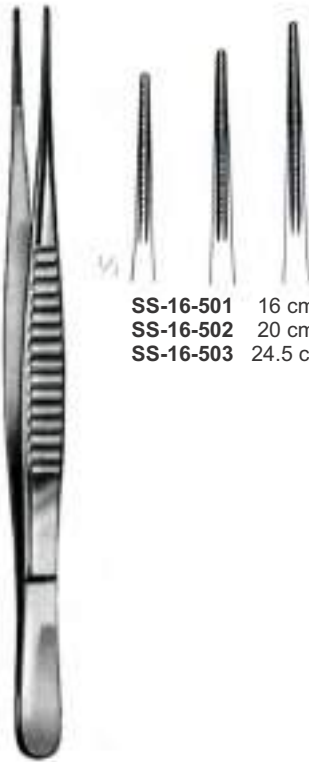

SS-16-501 16 cm / 6 1/4"
SS-16-502 20 cm / 8"
SS-16-503 24.5 cm / 9 3/4"

De Bakery
1.5 mm

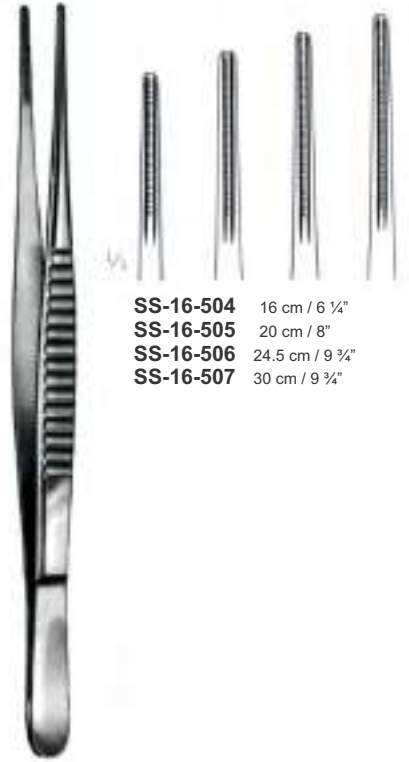

SS-16-504 16 cm / 6 1/4"
SS-16-505 20 cm / 8"
SS-16-506 24.5 cm / 9 3/4"
SS-16-507 30 cm / 9 3/4"

De Bakery
2.0 mm



SS-16-508 16 cm / 6 1/4"
SS-16-509 19.5 cm / 7 3/4"
SS-16-510 24.5 cm / 9 3/4"
SS-16-511 29.5 cm / 11 1/2"

De Bakery
2.0 mm

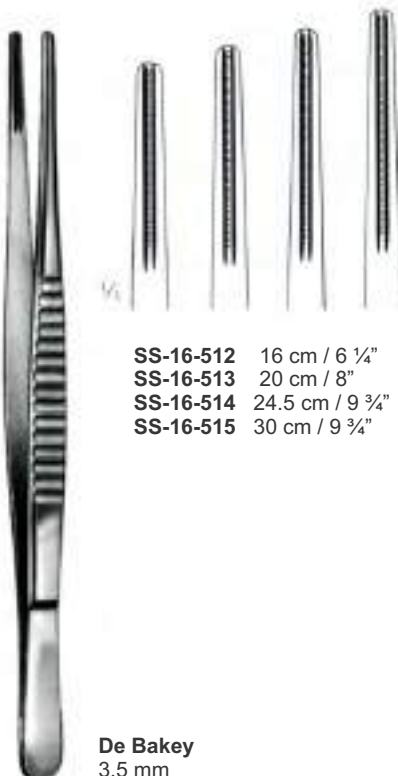

SS-16-512 16 cm / 6 1/4"
SS-16-513 20 cm / 8"
SS-16-514 24.5 cm / 9 3/4"
SS-16-515 30 cm / 9 3/4"

De Bakery
3.5 mm



SS-16-516 16 cm / 6 1/4"
SS-16-517 20 cm / 8"

De Bakery
2.0 mm



SAPTESTAR
Manufacturer & Exporter Of Surgical, Dental & Veterinary Instruments

Dissecting Forceps with Tungsten carbide edges
Pinzas de diseccion con filos de carbure tungsteno
Pincas a dissection avec des lames en tungstene



SS-16-518
17.5 cm / 7"



1:2
normal profile
perfil normal
profil normal

Bonney



SS-16-519
17.5 cm / 7"



1:2
normal profile
perfil normal
profil normal

Gerald



SS-16-520
15.5 cm / 6"



1:2
normal profile
perfil normal
profil normal

Gillies



SS-16-521
15 cm / 6"
mini profile
perfil mini
profil mini



Mc Indoe



SS-16-522
15.5 cm / 6"



1:2
normal profile
perfil normal
profil normal

Semkin



SS-16-523
17.5 cm / 7"



1:2



SS-16-524
15.5 cm / 6"



1:2
mini profile
perfil mini
profil mini



SS-16-525
17.5 cm / 7"



1:2

Dissecting Forceps with Tungsten carbide edges
Pinzas de diseccion con fillos de carbure tungsteno
Pincas a dissection avce des lames en tungstene



SS-16-526
12 cm / 4 3/4"
normal profile
perfil normal
profil normal

Adson-Brown

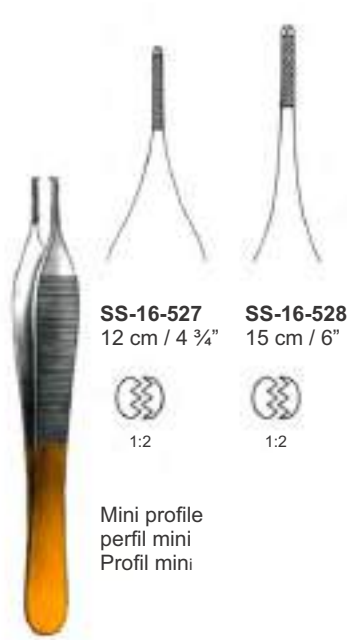

SS-16-527
12 cm / 4 3/4"
SS-16-528
15 cm / 6"
1:2 1:2

Mini profile
perfil mini
Profil mini

Adson

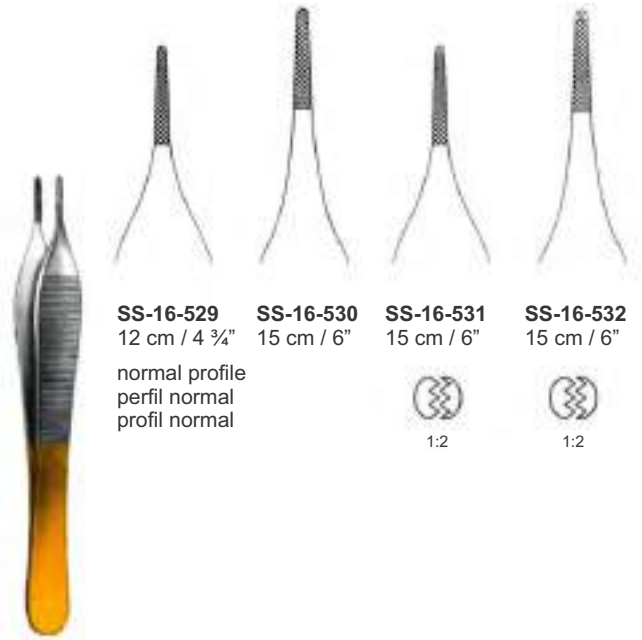

SS-16-529
12 cm / 4 3/4"
normal profile
perfil normal
profil normal
SS-16-530
15 cm / 6"
SS-16-531
15 cm / 6"
1:2
SS-16-532
15 cm / 6"
1:2

Adson



SS-16-533
17.5 cm / 7"
normal profile
perfil normal
profil normal

Cushing



SS-16-534
17 cm / 6 3/4"
normal profile
perfil normal
profil normal

Cushing



SS-16-535
18.5 cm / 7 1/4"
normal profile
perfil normal
profil normal

Cusging-Taylor



SAPTESTAR
Manufacturer & Exporter Of Surgical, Dental & Veterinary Instruments

Dissecting Forceps with Tungsten carbide edges
Pinzas de diseccion con filos de carbure tungsteno
Pincas a dissection avce des lames en tungstene



Potts-Smith



SS-16-536
16 cm / 6 1/4"



SS-16-537
18.5 cm / 7 1/4"



SS-16-538
20 cm / 8"



SS-16-539
23 cm / 9"



SS-16-540
25 cm / 9 3/4"

Normal profile
perfil normal
profil normal



Oehler



SS-16-541
14.5 cm / 5 3/4"



1:2



SS-16-542
16 cm / 6 1/4"



1:2



SS-16-543
18 cm / 7"



1:2



SS-16-544
20 cm / 8"



1:2



SS-16-545
25 cm / 9 3/4"



1:2

Normal profile
perfil normal
profil normal

Dissecting Forceps with tungsten carbide edges
Pinzas de diseccion con filos de carbure tungsteno
Pincas a dissection avec des lames en tungstene



Wangenstein



SS-16-546
15 cm / 6"



SS-16-547
23 cm / 9"



SS-16-548
16 cm / 6 ¼"



SS-16-549
20 cm / 8"



SS-16-550
24.5 cm / 9 ¾"

Micro profile
Perfil micro
Profil micro
1.6 mm



De Bakey



SS-16-551
16 cm / 6 ¼"



SS-16-552
20 cm / 8"



SS-16-553
24.5 cm / 9 ¾"

Mini profile
Perfil mini
Profil mini
2.0 mm

Atraumatic Dissecting Forceps with tungsten carbide edges
Pinzas de diseccion con filo carbure tungsteno
Pincas a dissection avce des lames en tungstene



SS-16-554
18 cm / 7"



Jaboma



SS-16-555
18 cm / 7"
1:2



Jaboma



SS-16-556
18 cm / 7"
1:2



Jaboma

Atraumatic Tissue Forceps
Pinzas quirurgicas
Pinces chirurgicales



1.5 mm

SS-16-557 15 cm
SS-16-558 19.5 cm
SS-16-559 24 cm

De Bakey



2.0 mm

SS-16-560 15 cm
SS-16-561 19.5 cm
SS-16-562 24 cm

De Bakey



2.7 mm

SS-16-563 15 cm
SS-16-564 19.5 cm
SS-16-565 24 cm
SS-16-566 30 cm

De Bakey



De Bakey atraumatic
serrations



3.5 mm

SS-16-567 19.5 cm
SS-16-568 24 cm
SS-16-569 30 cm

De Bakey



2.0 mm

SS-16-570 15 cm
SS-16-571 19.5 cm
SS-16-572 24 cm

De Bakey

Atraumatic Tissue Forceps
Pinzas quirurgicas
Pinces chirurgicales



SS-16-573 SS-16-574

SS-16-573 15 cm
SS-16-574 24 cm



SS-16-575 4 mm
BC-16-576 8 mm

SS-16-575 15 cm
SS-16-576 24 cm

Atraumatic Forceps with delicate parallel fluted toothing for gentle grasping and precise seizing of finest tissues.



SAPTESTAR

Manufacturer & Exporter Of Surgical, Dental & Veterinary Instruments



+92-340-4040061



exportsaptestar@gmail.com



info@saptestar.com



www.saptestar.com



Defence Road, Near Hotel Javson, 51310-Sialkot Pakistan





SAPTESTAR

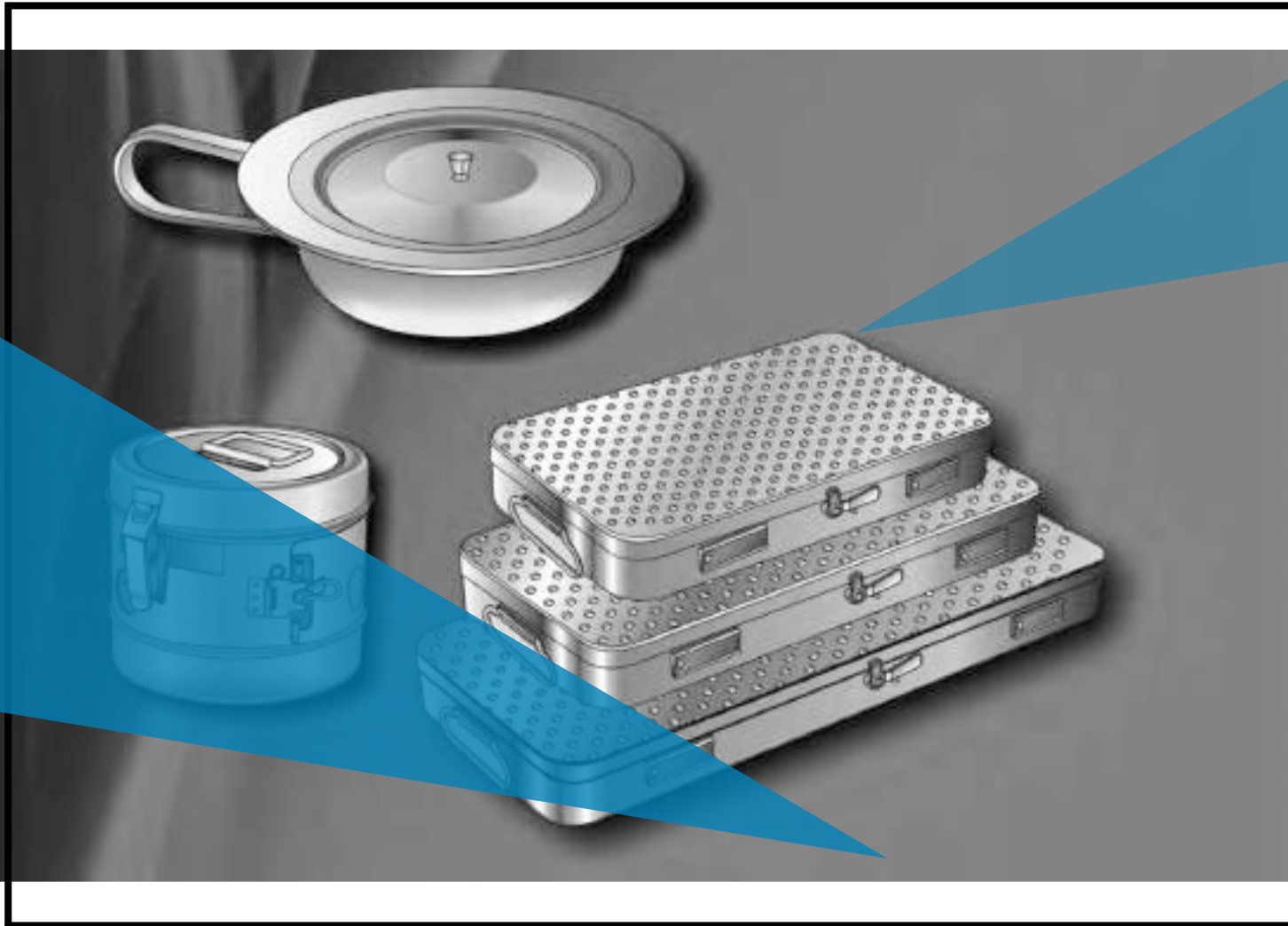

**Manufacturers & Exporters Of Quality Surgical Instruments
Holloware Catalogue**

Group 17

HOLLOWARE 17



+92-340-4040061



exportsaptestar@gmail.com



info@saptestar.com



www.saptestar.com



Defence Road, Near Hotel Javson, 51310-Sialkot Pakistan

Company Profile



ABOUT US

Quality begins at **SapteStar** Instruments Company where master craftsmen forge and manufacture each instrument to its exact specifications and measurements. Instruments must undergo a series of quality control inspections in order to be worthy of **SapteStar** name and warranty. We offer a wide selection of medical instruments including Surgical and Dental instruments.

We have acquired a unique and unmatched understanding of manufacturing through a large experience, working since 1908. Years of experience & state of the art manufacturing facilities helped us to keep our prices low. Our Surgical & Dental instruments are created by expert craftsmen, providing unfaltering quality you can rely on.

We have launched a fully interactive website where you can get online and track your orders 24 hours a day, 7 days in a week, and 365 days a year. Ask for our free e-catalogue on CD-Rom to save time and enjoy hassle free ordering.

We provide our customers with most reliable customer service as your satisfaction is our top priority. Our customers always enjoy our wonderful customer service and quality tools at the best price.

Lastly we invite you to have a work experience with SapteStar Instruments Company and we will prove ourselves as one of the most valuable source you have.

You can find us at

SapteStar
CEO



Company Profile



History

SAPTESTAR INSTRUMENTS was founded in 1995. Our Great Grandfather **Mian Muhammad Fazal Elahi** was the founder of M/s M.F. Elahi & Company (E.P.) Pvt. Ltd, established in 1908. SapteStar is a sister concern of M.F. Elahi & Co. It is our pride to be a member of M.F. Elahi Family.

SapteStar Instruments Company is located in the heart of beautiful city, Sialkot, Pakistan. We are manufacturers and exporters of quality Surgical, Dental instruments and Scissors of all sorts in various categories. We are closely attached with highly skilled surgeons and other technicians of the surgical industry to make the new instruments development possible.

SapteStar is in a continues process of development and testing of new instruments for their precision and perfect functioning. We are also working at imported forging supply by foreign customers.

Certificates

Instruments Company has achieved the certificates for ISO-9001, ISO-13485, cGMP (FDA) and CE Marking.

Quality Control

All material use in the manufacturing of our instruments are tested from relevant laboratories. Our continuous quality control is our best warranty so that you built confidence in our products.

Deliveries

Deliveries are quick and in-time.

Mode Of Payment

Terms of Payment is ADVANCE or LETTER OF CREDIT (Irrevocable)



Holloware 17

17 holloware

bed pans	13
bowls	09
bunt	05
cheattle	01
cotton dispensers	15
deponette	3,4
flat dishes	8, 9
instrument boxes	11
irrigatores	08
kidney dishes	13
luniatschek	15
martin	3,16
martin-proper	02
mayo	05
measurers	09
medicine cups	12
metal jars	10
methot	15
modell martin	15
needle cases	1,2
placenta pan	14
round bowls	8, 10
round dishes	9
round metal boxes	11
safty pins	5
sauerbruch	1,16
schimmelbusch	01
spirit lamps	16
sterilizing baskets	07
sterilizing drums	01
sterilizing forceps	01
sterilizing needle cases	01
storing cases	3, 4
storing cup	3, 4
trays	5, 6
triangular basins	14
universal trays	10
waste buket	16
waste cotton collector	15
waste forceps	16



Cheattle
SS-17-100
27 cm / 10½"
Sterilizing forceps

SS-17-103
30 cm / 11¾"



Schimmelbusch
without filter
laterally perforated
lockable by sliding mechanism

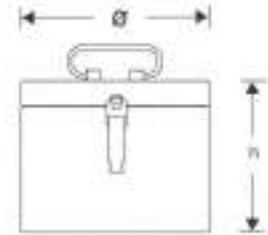

	Ø x h
SS-17-106	80 x 80 mm
SS-17-107	105 x 120 mm
SS-17-108	140 x 140 mm
SS-17-109	160 x 120 mm
SS-17-110	160 x 150 mm
SS-17-111	190 x 150 mm
SS-17-112	190 x 190 mm
SS-17-113	240 x 160 mm
SS-17-114	240 x 240 mm
SS-17-115	290 x 160 mm
SS-17-116	290 x 240 mm
SS-17-117	340 x 160 mm
SS-17-118	340 x 340 mm
SS-17-119	390 x 190 mm
SS-17-120	390 x 290 mm



Sauerbruch
SS-17-123
210 x 125 x 17 mm
Perforated lid and bottom



Sauerbruch
SS-17-126
210 x 125 x 17 mm
Perforated lid and bottom



	l x b x h
SS-17-130	50 x 25 x 4.5 mm
SS-17-131	65 x 42 x 8 mm
SS-17-132	75 x 25 x 4.5 mm

Needle Cases
Nadeletuis
Estuches para agujas



l x b x h
SS-17-136 50 x 25 x 4.5 mm
SS-17-137 65 x 42 x 8 mm
SS-17-138 75 x 25 x 4.5 mm



SS-17-141
 Ø 65 mm x 15 mm
 Complete with perforated interior box
SS-17-142
 62 x 13 mm
 Interior box
 perforated lid and bottom



SS-17-146
 135 x 100 x 25 mm



Martin-Propor
SS-17-149
 Ø 78 x 63 mm
 Drill Collecting box
 slotted lid for disposal of used burs



SS-17-152
 150 x 95 x 13 mm



SS-17-155
 150 x 95 x 13 mm
 Perforated lid and bottom



SS-17-159
 150 x 95 x 13 mm
 Perforated bottom



SS-17-162
 150 x 95 x 13 mm
 Perforated lid and bot tom



SS-17-165
 150 x 95 x 13 mm



SS-17-168
 150 x 95 x 13 mm
 Perforated lid and bottom



SS-17-171
 150 x 95 x 11 mm
 Needle tray
 perforated bottom

Storing Cup & Cases
Bereitstellungsbecher, Bereitschaftsboxen
Tarro para instrumentos, Cajas para almacenaje



SS-17-175
75 x 75 mm Ø
For micro Instruments
with exchangeable silicon plate



SS-17-179
Silicon plate



Dressing Forceps in jar with cap

Martin
SS-17-182
25 cm / 9¾"
Jar 20.5 cm high
with 25 cm long dressing forceps



Martin
SS-17-185
32 cm / 12½"
Jar 25.5 cm high
with 32 cm long dressing forceps



Deponette
SS-17-191
245 x 135 x 35 mm
Perforated bottom, with textile filter



Deponette
SS-17-195
245 x 135 x 50 mm
Perforated bottom, with textile filter

Storing Cases
Bereitschaftsboxen
Cajas para almacenaje



Deponette
SS-17-199
245 x 135 x 60 mm
Perforated bottom, with textile filter



Perforated lid and bottom with hinged lid		Spare textile filter package of 5 pairs
SS-17-202	230 x 130 x 50 mm	SS-17-222
SS-17-203	260 x 150 x 50 mm	SS-17-223
SS-17-204	275 x 235 x 50 mm	SS-17-224
SS-17-205	300 x 200 x 50 mm	SS-17-225
SS-17-206	325 x 275 x 50 mm	SS-17-226
SS-17-207	420 x 175 x 50 mm	SS-17-227
SS-17-210	230 x 130 x 75 mm	SS-17-230
SS-17-211	260 x 150 x 75 mm	SS-17-231
SS-17-212	300 x 200 x 75 mm	SS-17-232
SS-17-213	325 x 275 x 75 mm	SS-17-233
SS-17-214	420 x 175 x 75 mm	SS-17-234

Safety Pins, Trays
Steriliserklammer, Seibschalen
Imperdibles para instrumentos, Bandejas



Bunt
SS-17-237
12 cm / 4¾"



Mayo
SS-17-240
14 cm / 5"



Mayo
SS-17-243
14 cm / 5½"



SS-17-246
240 x 240 x 50 mm



SS-17-249 480 x 240 x 50 mm
SS-17-250 520 x 240 x 75 mm
SS-17-251 520 x 240 x 100 mm



SS-17-254
260 x 170 x 28 mm



SS-17-257
260 x 170 x 47 mm

Trays
Seibschalen
Bandejas

Sterilizing tray of perforated steel sheet



SS-17-260
260 x 130 x 50 mm
Perforated steel sheet

SS-17-263 260 x 260 x 50 mm
SS-17-264 260 x 260 x 80 mm
SS-17-265 260 x 260 x 100 mm

SS-17-268
Perforated steel sheet
for micro instruments
with silicone inserts and lid



SS-17-271
280 x 130 x 50 mm

SS-17-274 260 x 260 x 50 mm
SS-17-275 480 x 260 x 50 mm



SS-17-278 480 x 260 x 50 mm
SS-17-279 520 x 260 x 50 mm
SS-17-280 520 x 260 x 80 mm
SS-17-281 520 x 260 x 100 mm



SS-17-284
600 x 300 x 130 mm



SS-17-287
600 x 300 x 260 mm



SAPTESTAR
 Manufacturer & Exporter Of Surgical, Dental & Veterinary Instruments

Irrigadores, Round Bowls, Flat Dishes
 Irrigatoren, Rund Schüsseln, Flachschaalen
 Irrigadores, Cubetas redondas, Cubetas planas



capacity in L
SS-17-290 1.01
SS-17-291 1.51
SS-17-292 2.01



capacity in L
SS-17-295 0.5
SS-17-296 1.0
SS-17-297 2.0
SS-17-298 3.0



	Ø x h	
SS-17-301	150 x 70 mm	0.75 L
SS-17-302	160 x 65 mm	1.00 L
SS-17-303	220 x 70 mm	2.00 L
SS-17-304	240 x 95 mm	3.00 L
SS-17-305	260 x 130 mm	4.50 L
SS-17-306	300 x 105 mm	6.00 L
SS-17-307	320 x 140 mm	8.50 L
SS-17-308	380 x 125 mm	11.00 L
SS-17-309	400 x 150 mm	14.00 L



SS-17-312
 Lid only



SS-17-315 Ø 110 x 27 mm 0.20 L
SS-17-316 Ø 110 x 40 mm 0.30 L



SS-17-319 Ø 330 x 90 mm 6.00 L
SS-17-320 Ø 330 x 115 mm 8.00 L



SS-17-323 40 x 19 mm 0.05 L
SS-17-324 61 x 30 mm 0.07 L
SS-17-325 80 x 40 mm 0.14 L
SS-17-326 116 x 50 mm 0.35 L
SS-17-327 128 x 55 mm 0.45 L
SS-17-328 147 x 65 mm 0.70 L
SS-17-329 167 x 75 mm 1.10 L
SS-17-330 187 x 85 mm 1.60 L



SS-17-333 116 x 35 mm 0.301
SS-17-334 128 x 38 mm 0.401
SS-17-335 147 x 40 mm 0.501
SS-17-336 157 x 45 mm 0.751
SS-17-337 187 x 45 mm 1.001



Ø x h
SS-17-340 110 x 28 mm 0.15 L



SS-17-343
100 cc, 0.1 L
Graduated inside



Graduated inside
SS-17-346 0.25 L
SS-17-347 0.50 L
SS-17-348 1.00 L
SS-17-349 2.00 L



Ø x h
SS-17-352 100 x 20 mm
with lid



Ø x h
SS-17-355 96 x 20 mm
without lid



SS-17-358
Storage rack for petri dishes



SS-17-361 96 x 20 mm
SS-17-362 100 x 20 mm
SS-17-363 100 x 16 mm

SS-17-365
Spare glass plate only



SS-17-368
Partition

Universal Trays, Round Bowls, Metal Jars
 Mehrzweckschalen, Runde Schüsseln, Standgefäße
 Bandejas universales, Cubetas redondas, Tarros metálicos



- SS-17-371** 230 x 155 x 30 mm
- SS-17-372** 300 x 175 x 30 mm
- SS-17-373** 300 x 175 x 40 mm
- SS-17-374** 350 x 240 x 36 mm
- SS-17-375** 400 x 300 x 50 mm

- SS-17-380** 210 x 160 x 10 mm
- SS-17-381** 240 x 180 x 10 mm
- SS-17-382** 310 x 150 x 10 mm
- SS-17-383** 310 x 210 x 10 mm
- SS-17-384** 350 x 240 x 10 mm
- SS-17-385** 400 x 270 x 20 mm
- SS-17-386** 420 x 280 x 10 mm



SS-17-389
 125 x 80 x 12 mm

SS-17-392 l x b x h
 235 x 190 x 40 mm

SS-17-395 Ø 220 x 70 mm



- SS-17-398** Ø 30 x 90 mm
- SS-17-400** Ø 50 x 100 mm
- SS-17-401** Ø 50 x 130 mm
- SS-17-402** Ø 50 x 175 mm
- SS-17-405** Ø 75 x 100 mm
- SS-17-406** Ø 75 x 130 mm
- SS-17-407** Ø 75 x 175 mm
- SS-17-410** Ø 100 x 175 mm
- SS-17-411** Ø 100 x 200 mm



Lid only, closed

Lid only with triangular opening

- SS-17-415**
- SS-17-416**
- SS-17-417**

- SS-17-430**
- SS-17-431**
- SS-17-432**

- SS-17-420**
- SS-17-421**
- SS-17-422**

- SS-17-435**
- SS-17-436**
- SS-17-437**

- SS-17-425**
- SS-17-426**

- SS-17-440**
- SS-17-441**

Instrument Boxes, Round Metal Boxes
Instrumentenkästen, Runde Metalldossen
Cajas para instrumentos, Cajas metálicas redondas



Lid with knob
l x b x h

SS-17-445	165 x 85 x 35 mm
SS-17-447	200 x 100 x 35 mm
SS-17-448	200 x 100 x 50 mm
SS-17-449	230 x 130 x 50 mm
SS-17-450	260 x 150 x 50 mm
SS-17-451	270 x 235 x 50 mm
SS-17-452	300 x 200 x 50 mm
SS-17-453	325 x 275 x 50 mm



Lid without knob
l x b x h

SS-17-460	165 x 85 x 35 mm
SS-17-461	200 x 100 x 35 mm
SS-17-462	200 x 100 x 50 mm
SS-17-463	230 x 130 x 50 mm
SS-17-464	260 x 150 x 50 mm
SS-17-465	270 x 235 x 50 mm
SS-17-467	300 x 200 x 50 mm
SS-17-468	324 x 275 x 30 mm
SS-17-469	325 x 275 x 50 mm
SS-17-471	420 x 80 x 40 mm
SS-17-472	420 x 175 x 50 mm



l x b x h
SS-17-476 205 x 105 x 35 mm



	Ø x h
SS-17-480	75 x 60 mm
SS-17-481	75 x 75 mm
SS-17-483	100 x 60 mm
SS-17-484	100 x 100 mm
SS-17-486	125 x 80 mm
SS-17-487	125 x 125 mm
SS-17-489	150 x 150 mm

Medicine Cups
Medizinbecher
Vasos medicinales



SS-17-492
25 ccm
Graduated inside



SS-17-495
50 ccm
Graduated inside



SS-17-498
20 ccm
Medicine spoon
graduated inside



SS-17-501
Ø 75 x 12 mm
Tablet tray



SS-17-504
Ø 90 x 90 mm
Metal cup



SS-17-507
Ø 75 x 50 mm
Denture cup
with lid



SS-17-510
Ø 75 x 80 mm
Sputum cup



SS-17-513
Ø 75 x 80 mm



SS-17-516
Ø 75 x 80 mm



SS-17-519
Ø 73 x 75 mm
Insert for cup

Kidney Dishes, Bed Pans
Neirenschale, Stechbecken
Riñoneras, Silletas



	l x b x h
SS-17-523	170 x 100 x 35 mm
SS-17-524	250 x 140 x 40 mm
SS-17-525	275 x 150 x 45 mm

Lid for kidney
SS-17-528



SS-17-531	235 mm Ø
SS-17-532	310 mm Ø



Lid with hook handles	without lid
SS-17-536	SS-17-538 235 mm Ø
SS-17-537	SS-17-539 310 mm Ø

Triangular Basins, Placenta Pan
Dreieckschale, Plazentabecken
Cubetas triangulares, Cubeta Placenta



Lid with knob
SS-17-542
220 Ø x 120 mm



SS-17-546
Graduated inside up to 600 ml,
with handle



SS-17-549
Graduated inside up to 600 ml



SS-17-552



SS-17-555



SS-17-558
340 mm Ø



Luniatschek
SS-17-561
60 x 60 x 30 mm Ø



SS-17-564
50 x 100 mm Ø
Powder pot



SS-17-567
75 x 90 mm Ø
with suckers



SS-17-568
100 x 130 mm Ø
with suckers

Modell Martin
SS-17-571 75 Ø x 90 mm
SS-17-572 100 Ø x 130 mm



Methot
SS-17-575
50 x 75 mm Ø
with lid



Methot
SS-17-578
50 x 75 mm Ø
without lid



Methot
SS-17-581
50 x 75 mm Ø



Methot
SS-17-584
45 x 55 mm Ø
Insert

Spirit Lamps, Waste Bucket, Waste Forceps
 Spirituslampen, Abfalleimer, Abfallzangen
 Lámparas de alcohol, Cobo para desechos, Pinzas para deschos



SS-17-587
 120 ccm



SS-17-590
 120 ccm



SS-17-593
 120 ccm



SS-17-596
 Spare wick
 4 mm
 round, per meter



BC-17-597
 Spare wick
 4 mm
 round 12 cm long

SS-17-600
 Spare wick
 12 mm
 flat, per meter

SS-17-601
 Spare wick
 12 mm
 flat, 12 cm long



SS-17-607
 325 mm Ø x 305 mm
 Capacity 15l



SS-17-604
 Lid



Martin
SS-17-610
 58 cm / 22³/₄"



Sauerbruch
SS-17-613
 55 cm / 21¹/₂"



SAPTESTAR

Manufacturer & Exporter Of Surgical, Dental & Veterinary Instruments



+92-340-4040061



exportsaptestar@gmail.com



info@saptestar.com



www.saptestar.com



Defence Road, Near Hotel Javson, 51310-Sialkot Pakistan





SAPTESTAR

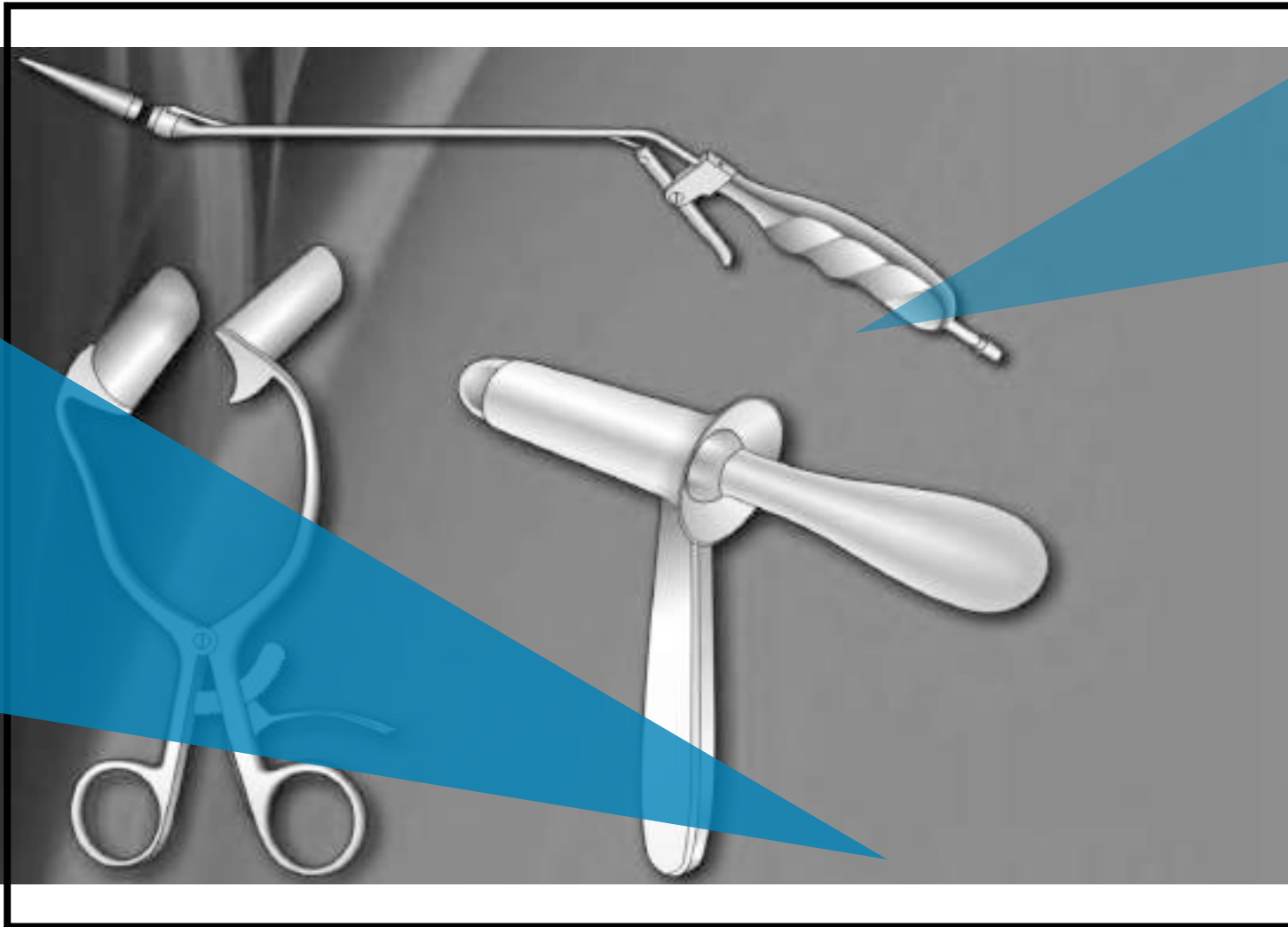

**Manufacturers & Exporters Of Quality Surgical Instruments
Rectal Instruments Catalogue**

Group 18

Rectal Instruments 18

-  +92-340-4040061
-  exportsaptestar@gmail.com
-  info@saptestar.com
-  www.saptestar.com
-  Defence Road, Near Hotel Javson, 51310-Sialkot Pakistan

Company Profile



ABOUT US

Quality begins at **SapteStar** Instruments Company where master craftsmen forge and manufacture each instrument to its exact specifications and measurements. Instruments must undergo a series of quality control inspections in order to be worthy of **SapteStar** name and warranty. We offer a wide selection of medical instruments including Surgical and Dental instruments.

We have acquired a unique and unmatched understanding of manufacturing through a large experience, working since 1908. Years of experience & state of the art manufacturing facilities helped us to keep our prices low. Our Surgical & Dental instruments are created by expert craftsmen, providing unfaltering quality you can rely on.

We have launched a fully interactive website where you can get online and track your orders 24 hours a day, 7 days in a week, and 365 days a year. Ask for our free e-catalogue on CD-Rom to save time and enjoy hassle free ordering.

We provide our customers with most reliable customer service as your satisfaction is our top priority. Our customers always enjoy our wonderful customer service and quality tools at the best price.

Lastly we invite you to have a work experience with SapteStar Instruments Company and we will prove ourselves as one of the most valuable source you have.

You can find us at

SapteStar
CEO



Company Profile



History

SAPTESTAR INSTRUMENTS was founded in 1995. Our Great Grandfather **Mian Muhammad Fazal Elahi** was the founder of M/s M.F. Elahi & Company (E.P.) Pvt. Ltd, established in 1908. SapteStar is a sister concern of M.F. Elahi & Co. It is our pride to be a member of M.F. Elahi Family.

SapteStar Instruments Company is located in the heart of beautiful city, Sialkot, Pakistan. We are manufacturers and exporters of quality Surgical, Dental instruments and Scissors of all sorts in various categories. We are closely attached with highly skilled surgeons and other technicians of the surgical industry to make the new instruments development possible.

SapteStar is in a continues process of development and testing of new instruments for their precision and perfect functioning. We are also working at imported forging supply by foreign customers.

Certificates

Instruments Company has achieved the certificates for ISO-9001, ISO-13485, cGMP (FDA) and CE Marking.

Quality Control

All material use in the manufacturing of our instruments are tested from relevant laboratories. Our continuous quality control is our best warranty so that you built confidence in our products.

Deliveries

Deliveries are quick and in-time.

Mode Of Payment

Terms of Payment is ADVANCE or LETTER OF CREDIT (Irrevocable)



Rectal 18

18 intestine

Chaput	01	Pratt	23
Baby-Allis	01	Mathieu	23
Ochsner-Allis	01	Sims	24
Baby-Allis	01	Sims	24
Allis	01	Brinkerhoff	24
Allis	02	Kelly	25
Boys-Allis	02	Hirschmann	25
Adair- Allis	02	Ives-Fansler	25
Judd- Allis	02	Roschke	25
Judd0- Allis	02	Barr	26
Allis	02	Smith-Buie	26
Thoms- Allis	03	Alan-Park	26
Allis	03	Mc Givney	27
Allis	03	Rudd	27
Babcock	03	Haemorrhoidal Suction Ligatora	28
Collin	04	Yeoman	29
Duval-Collin	04	ST.Mark	30
Lockwood	04	Park	30
Duval	04	Hil-Ferguson	30
Pennington	05	Sawyer	30
Loveace	05	Smith-Buie	30
Duval	05		
Williams	06		
Duval	06		
Babcock	06		
Babcock	07		
Duval	07		
Allis	08		
Babcock	08		
Collin	08		
Allis	09		
Redo	09		
Bainbridge	09		
Abay-Kocher	10		
Baby-Doyen	10		
Doyen	11		
Kocher	11		
Doyen	11		
Doyen	12		
Kocher	12		
Doyen	12		
Kocher	13		
Kocher	14		
Mayo-Robson	15		
Scudder	16		
Thoriakson	17		
Thoriakson	18		
Brunner	19		
Hayes	19		
Fehland	20		
Resano	20		
De Martel-Wolfson	21		
Kleinschmidt	21		
Benson	22		
Baby-Payr	22		
Payr	22		
Czerny	23		
Sims	23		

Intestinal & Tissue Grasping Forceps
 Pinzas intestinales y para tejidos
 Pincas a prehension de l'intestin



Chaput
SS-18-101
 12.5 cm / 5"
 2x3 teeth
 2x3 dientes
 2x3 dents



Baby-Allis
SS-18-102
 12 cm / 4 3/4"
 4x5 teeth
 4x5 dientes
 4x5 dents



Ochsner-Allis
SS-18-103
 13.5 cm / 5 1/4"
 4x5 teeth
 4x5 dientes
 4x5 dents



Baby-Allis
SS-18-104
 14 cm / 5 1/2"
 4x5 teeth
 4x5 dientes
 4x5 dents



Allis
SS-18-105
 15.5 cm / 6"
 4x5 teeth
 4x5 dientes
 4x5 dents

Intestinal & Tissue Grasping Forceps
 Pinzas intestinales y para tejidos
 Pincas a prehension de l'intestin



Allis
SS-18-106
 15.5 cm / 6"
 5x6 teeth
 5x6 dientes
 5x6 dents



Boys-Allis
SS-18-107
 15.5 cm / 6"
 5x6 teeth
 5x6 dientes
 5x6 dents



Adair-Allis
SS-18-108
 16 cm / 6 1/4"
 10x11 teeth
 10x11 dientes
 10x11 dents



Judd-Allis
SS-18-109
 15.5 cm / 6"
 3x4 teeth
 3x4 dientes
 3x4 dents



Judd-Allis
SS-18-110
 19 cm / 7 1/2"
 3x4 teeth
 3x4 dientes
 3x4 dents



Allis
SS-18-11
 19 cm / 7 1/2"
 5x6 teeth
 5x6 dientes
 5x6 dents

Intestinal & Tissue Grasping Forceps
 Pinzas intestinales y para tejidos
 Pincas a prehension de l'intestin



8x9 teeth
 8x9 dientes
 8x9 dents

Thoms-Allis
SS-18-112
 20.5 cm / 8" ½



5x6 teeth
 5x6 dientes
 5x6 dents

Allis
SS-18-113
 22.5 cm / 9" ½



5x6 teeth
 5x6 dientes
 5x6 dents

Allis
SS-18-114
 25 cm / 10" ½



Babcock ½



SS-18-115
 14.5 cm / 5 ¾"



SS-18-116
 16 cm / 6 ¼"



SS-18-117
 17 cm / 6 ¾"



SS-18-118
 20.5 cm / 8"



SS-18-119
 23.5 cm / 9 ¼"

Intestinal & Tissue Grasping Forceps
 Pinzas intestinales y para tejidos
 Pincas a prehension de l'intestin



Collin
SS-18-120
 13.5 cm / 5 1/4"



SS-18-121
 20.5 cm / 8"

Duval-Collin



SS-18-122
 20.5 cm / 8"



Lockwood
SS-18-123
 20 cm / 8"



SS-18-124
 23 cm / 9"

Duval



SS-18-125
 23 cm / 9"

Intestinal & Tissue Grasping Forceps
Pinzas intestinales y para tejidos
Pincas a prehension de l'intestin



Pennington
SS-18-126
15 cm / 6"



Pennington
SS-18-127
20 cm / 8"



Lovelace
SS-18-128
19 cm / 7 1/2"



SS-18-129
20 cm / 8"



SS-18-130
20 cm / 8"



SS-18-131
22.5 cm / 9"

SS-18-132
22.5 cm / 9"

Intestinal & Tissue Grasping Forceps
 Pinzas intestinales y para tejidos
 Pincas a prehension de l'intestin



Williams
SS-18-133
 16 cm / 6 1/4"



Duval
SS-18-134
 20.5 cm / 8"
 with tungsten carbide inserts
 con bocas de carburo tungsteno
 avec mors en tungstene



SS-18-135
 16 cm / 6 1/4"

Babcock
 with tungsten carbide inserts
 con bocas de carburo tungsteno
 avec mors en tungstene



SS-18-136
 17.5 cm / 7"



SS-18-137
 20.5 cm / 8"

Intestinal & Tissue Grasping Forceps
Pinzas intestinales y para tejidos
Pinces a prehension de l'intestin



Babcock

1/2

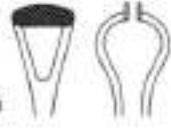

SS-18-138
16.5 cm / 6 1/2"



SS-18-139
21 cm / 8 1/4"



1/2

SS-18-140
20.5 cm / 8"



Duval

Intestinal & Tissue Grasping Forceps
 Pinzas intestinales y para tejidos
 Pincas a prehension de l'intestin



Allis

SS-18-141
 15.5 cm / 6"

SS-18-142
 19 cm / 7 1/2"

SS-18-143
 25 cm / 10"

SS-18-144
 30 cm / 12"



Babcock

SS-18-145
 16 cm / 6 1/4"

SS-18-146
 20.5 cm / 8"



Collin

SS-18-147
 20.5 cm / 8"

SS-18-148
 23 cm / 9"



SS-18-149
 25 cm / 10"

SS-18-150
 26 cm / 10 1/4"

Intestinal Clamps Forceps
Pinzas-clamps intestinales
Pinces-clamps intestinales



Allen
1x2 teeth
1x2 dientes
1x2 dents



SS-18-151
15 cm / 6"



SS-18-152
20 cm / 8"



Redo
1x2 teeth
1x2 dientes
1x2 dents



SS-18-153
20 cm / 8"



SS-18-154
26 cm / 10 1/4"



Rainbridge



SS-18-155
15 cm / 6"



SS-18-156
18.5 cm / 7 1/4"



SS-18-157
15 cm / 6"



SS-18-158
18.56 cm / 7 1/4"

Intestinal Clamps Forceps
 Pinzas-clamps intestinales
 Pincas-clamps intestinales



SS-18-159
 13 cm / 5 1/8"

SS-18-160
 13 cm / 5 1/8"

Soft elastic
 elasticas (suave)
 souples

1/2

Baby-Kocher



SS-18-161
 13 cm / 5 1/8"

SS-18-162
 13 cm / 5 1/8"

Soft elastic
 elasticas (suave)
 souples

1/2

Baby-Kocher



SS-18-163
 17 cm / 6 3/4"

SS-18-164
 17 cm / 6 3/4"

Soft elastic
 elasticas (suave)
 souples

1/2

Baby-Doyen



SS-18-165
 17 cm / 6 3/4"

SS-18-166
 17 cm / 6 3/4"

Soft elastic
 elasticas (suave)
 souples

1/2

Baby-Doyen

Intestinal Clamps Forceps
Pinzas-clamps intestinales
Pinces-clamps intestinales

With non-traumatic serration
con bocas atraumaticas
avec mors atrauma



SS-18-167
21 cm / 8 ¼"

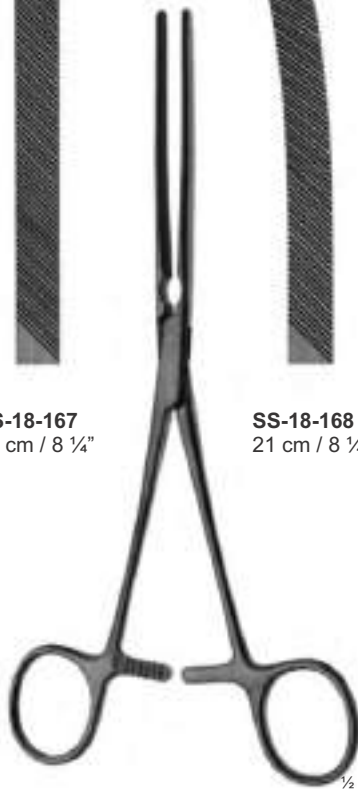

Doyen
soft elastic
elásticas (suave)
souples



SS-18-168
21 cm / 8 ¼"



SS-18-169
21 cm / 8 ¼"

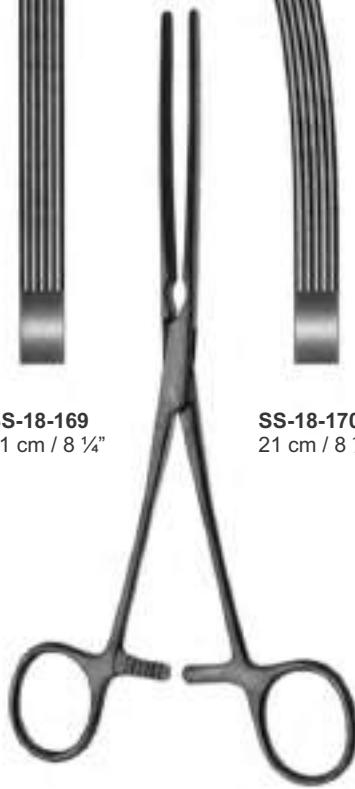

Kocher
soft elastic
elásticas (suave)
souples



SS-18-170
21 cm / 8 ¼"



SS-18-171
21 cm / 8 ¼"



Doyen
soft elastic
elásticas (suave)
souples

SS-18-172
21 cm / 8 ¼"

Intestinal Clamps Forceps
 Pinzas-clamps intestinales
 Pinces-clamps intestinales

With non-traumatic serration
 con bocas atraumaticas
 avec mors atrauma
 con morsi atraumatici



SS-18-173
 23 cm / 9"



SS-18-174
 23 cm / 9"



SS-18-175
 23 cm / 9"



SS-18-176
 23 cm / 9"



SS-18-177
 23 cm / 9"



SS-18-178
 23 cm / 9"

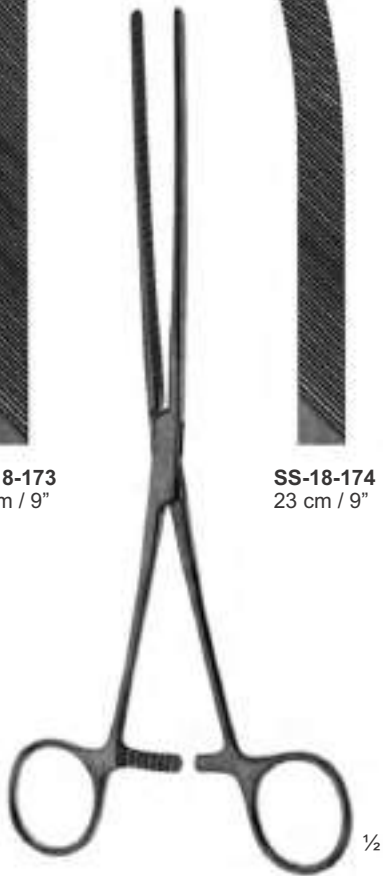

Doyen
 soft elastic
 elasticas (sauve)
 souples

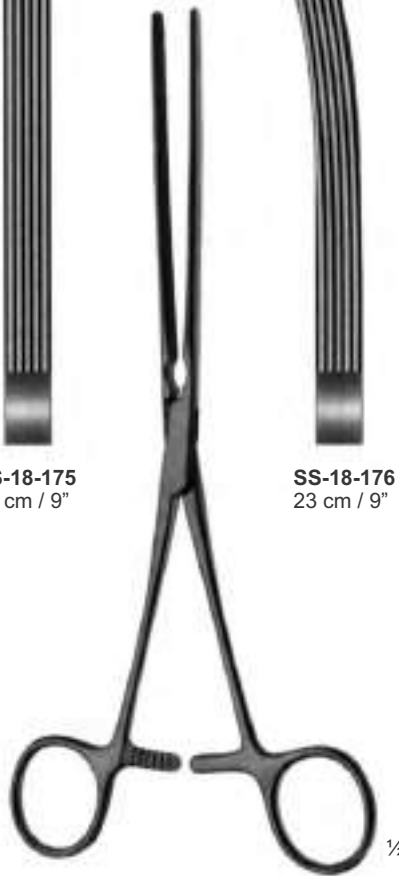

Kocher
 soft elastic
 elasticas (sauve)
 souples



Doyen
 soft elastic
 elasticas (sauve)
 souples

Intestinal Clamps Forceps
 Pinzas-clamps intestinales
 Pinces-clamps intestinales

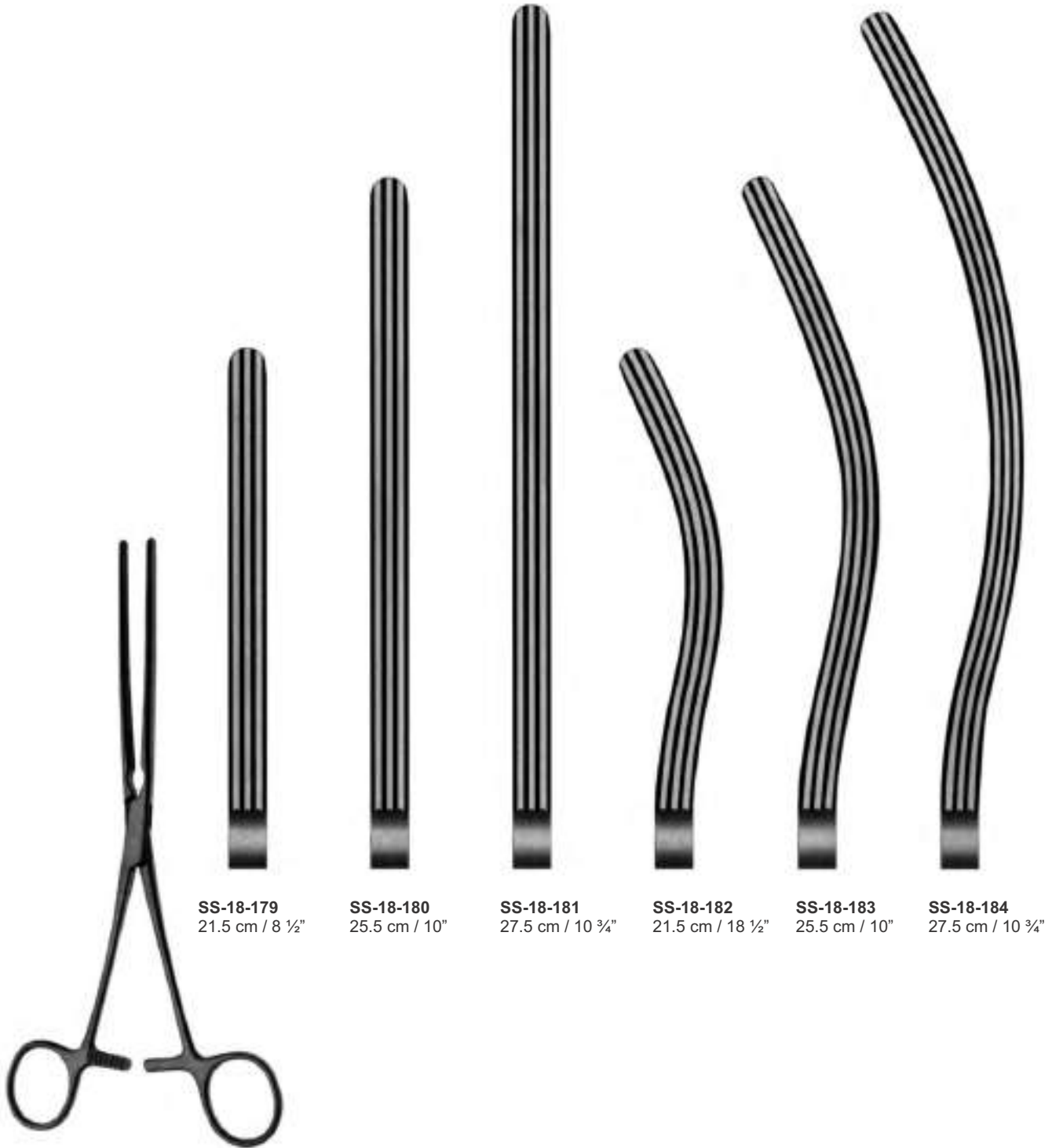

SS-18-179
 21.5 cm / 8 ½"

SS-18-180
 25.5 cm / 10"

SS-18-181
 27.5 cm / 10 ¾"

SS-18-182
 21.5 cm / 18 ½"

SS-18-183
 25.5 cm / 10"

SS-18-184
 27.5 cm / 10 ¾"

Kocher
 soft elastic
 elasticas (sauve)
 souples

Intestinal Clamps Forceps
Pinzas-clamps intestinales
Pinces-clamps intestinales



Intestinal Clamps Forceps
Pinzas-clamps intestinales
Pinces-clamps intestinales



SS-18-191
25.5 cm / 10"



SS-18-192
25.5 cm / 10"



SS-18-193
25.5 cm / 10"



SS-18-194
25.5 cm / 10"

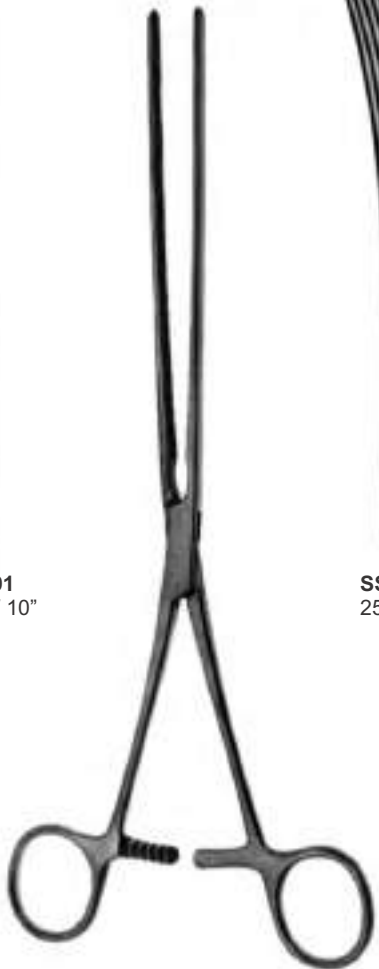

Mayo-Robson
hard elastic
elásticas (duro)
fermes

½



Mayo-Robson
hard elastic, with non-traumatic serration
elásticas (duro), con bocas atraumáticas
fermes, avec mors atrauma

½

Stomach Clamps Forceps
Pinzas-clamps estomacales
Pinces-clamps stomacales



SS-18-195
33 cm / 13"



Scudder



SS-18-196
33 cm / 13"



Thorlakson
SS-18-197
29 cm / 11 1/2"
for use in anterior resection of the rectum
para el uso da la reseccion anterior del recto
Utilise pour la reseccion anterieure du rectum

Lower Occlusive Clamps
Pinzas-clamps oclusiva interior
Pinces-clamps a occlusion



**Thorlakson
SS-18-198**
29 cm / 11 1/2"
For use in anterior resection of the
rectum on the female patient
Para el uso de la reseccion anterior
del recto de la mujer
utilise pour la reseccion anterieure du
rectum chez la femme

1/2



**Thorlakson
SS-18-199**
29 cm / 11 1/2"
For use in anterior resection of the
rectum on the male patient
Para el uso de la reseccion anterior
del recto del hombre
utilise pour la reseccion anterieure du
rectum chez l' homme

1/2

Sigmoid Anastomosis Forceps
 Pinzas para anastomosis de recto
 Pinces clamps a anastomose du rectum



Brunner
SS-18-200
 26.5 cm / 10 1/2"



SS-18-201
 30 cm / 12"

SS-18-202
 30.5 cm / 12"

With non-traumatic serration
 con bocas atraumaticas
 avec mors atrauma



Hayes

Sigmoid Anastomosis Forceps
Pinzas para anastomosis de recto
Pincas clamps a anastomose du rectum



Clamps Closing Forceps
Pinzas para cerrar los clamps
Pinces pour fermer les clamps



De Martel-Wolfson
SS-18-206
24.5 cm / 9 $\frac{3}{4}$ "
Clamp closing forceps
Pinzas para cerrar los clamps
Pince pour fermer les clamps



Kleinschmidt
SS-18-207
12.5 cm / 5"
Super crusher and appendectomy clamp
Machacadora para espora y clamp para apendectomia
Ecraseur et clamp a appendicectomie



SAPTESTAR
Manufacturer & Exporter Of Surgical, Dental & Veterinary Instruments

Intestine & Stomach Clamps
Pinzas-clamps intestinales y estomacales
Pinces-clamps pour l'intestinales et l'estomac



Benson
SS-18-208
15.5 cm / 6"
Pylorus spreader
Separador para piloro
Ecarteur du pylore



Baby-Payr
SS-18-209
15.5 cm / 6"
Intestinal and stomach clamp with pin
Pinza-clamp intestinales y estomacales
con espiga
Pince-clamp et ecraseurs pour l'intestin
et l'estomac avec pointe



SS-18-210
20 cm / 8"



SS-18-211
29 cm / 11 1/2"

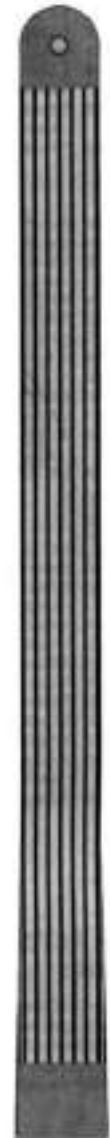

SS-18-212
34 cm / 13 1/2"



Payr
Intestinal and stomach clamps with pin
Pinzas-clamps intestinales y estomacales
con espiga
Pince-clamps et ecraseurs pour l'intestin
et l'estomac avec pointe

Rectal Speculs
Especulos para el recto
Speculum rectaux



Rectal Speculs
Especulos para el recto
Speculum rectaux



SS-18-219 80 x 25 mm (AXB)
SS-18-220 125 x 25 mm (AXB)
SS-18-221 150 x 25 mm (AXB)



50 mm



Kelly
SS-18-224 ø 21 mm x 50 mm
SS-18-225 ø 27 mm x 50 mm
Sphincteroscopes
Esfinteroscopios
Sphincteroscopes

65 mm



Hirschmann
SS-18-226 ø 19 mm x 65 mm
SS-18-227 ø 22 mm x 65 mm
Anoscopes
Anoscopios
Anuscopes

80 mm



Ives-Fansler
SS-18-228
ø 22 mm x 80 mm
Anoscope with vulcanite obturator
Anoscopio con obturador de plástico
Anuscopes avec opturateur en ebonite

70 mm



Roschke
SS-18-229
ø 15-30 mm x 70 mm
Rectal retractor
Separador para el recto
Dilatateur pour anus



SAPTESTAR
 Manufacturer & Exporter Of Surgical, Dental & Veterinary Instruments

Rectal Retractor
 Separador para el recto
 Dilatateurs pour anus et rectum

70 x 22 mm
 (AXB)



Barr
SS-18-230
 18.5 cm / 7 1/4"

55 x 23 mm
 (AXB)



Smith-Buie
SS-18-231

SS-18-234



SS-18-236

Alan-Park
SS-18-232
 14.5 cm / 5 3/4"

Rectal retractor with ball snap closure, complete, consisting of:

- SS-18-233** 1 Spreader
- SS-18-234** 1 pair lateral valves 75 x 22 mm (AXB)
- SS-18-235** 1 pair lateral valves 95 x 22 mm (AXB)
- SS-18-236** 1 Central valve 95 x 22 mm (AXB)

Separador para el recto con cierre esferico, completo, compuesto de

- SS-18-233** 1 Separador
- SS-18-234** 1 Par de valvas laterales 75 x 22 mm (AXB)
- SS-18-235** 1 Par de valvas laterales 95 x 22 mm (AXB)
- SS-18-236** 1 Valve central 95 x 22 mm (AXB)

Ecarteur rectal, complet, compose de:

- SS-18-233** 1 Dilataeur
- SS-18-234** 1 Paire de valvas laterales 75 x 22 mm (AXB)
- SS-18-235** 1 Paire de valvas laterales 95 x 22 mm (AXB)
- SS-18-236** 1 Valve centrale 95 x 22 mm (AXB)



SS-18-235

Haemorrhoidal Forceps
Pinza-clamps para hemorroides
Pinces-clamps pour hemorroides



SS-18-400
Shaft = 17 cm



Mc Givney
SS-18-237
19 cm / 7 1/2"
Haemorrhoidal Forceps
Pinza-clamp para hemorroides
Pinces-clamps pour hemorroides



SS-18-238
Ligature rubber rings, in package of 100 pieces
Anillos de goma para ligadura, en paquete de 100 piezas
Bagues de caoutchouc pour ligatures, paquet de 100 pieces



Rudd
SS-18-239
27.5 cm / 10 3/4"
Haemorrhoidal ligator with loading attachment Ø 12 mm (SS-18-240)
Ligador para hemorroides con cono de carga Ø 12 mm (SS-18-240)
Ligateur hemorroïdal avec cone de charge Ø 12 mm (SS-18-240)

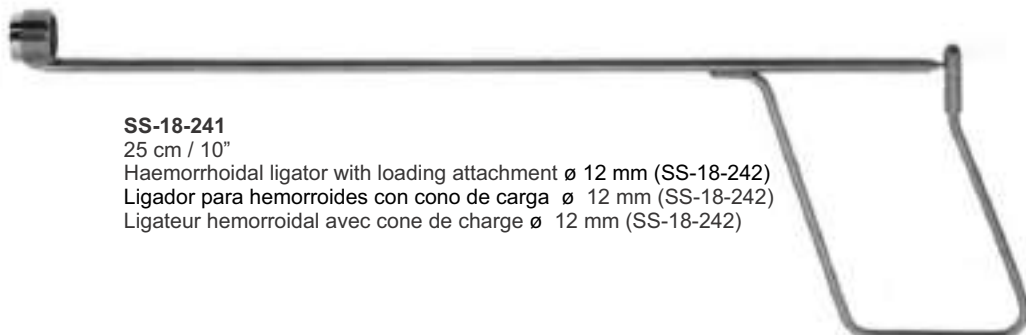

SS-18-241
25 cm / 10"
Haemorrhoidal ligator with loading attachment Ø 12 mm (SS-18-242)
Ligador para hemorroides con cono de carga Ø 12 mm (SS-18-242)
Ligateur hemorroïdal avec cone de charge Ø 12 mm (SS-18-242)



SAPTESTAR
Manufacturer & Exporter Of Surgical, Dental & Veterinary Instruments

Haemorrhoidal Suction Ligator
Ligadores de aspiracion para hemorroides
Ligateurs aspirateurs pour hemorroides

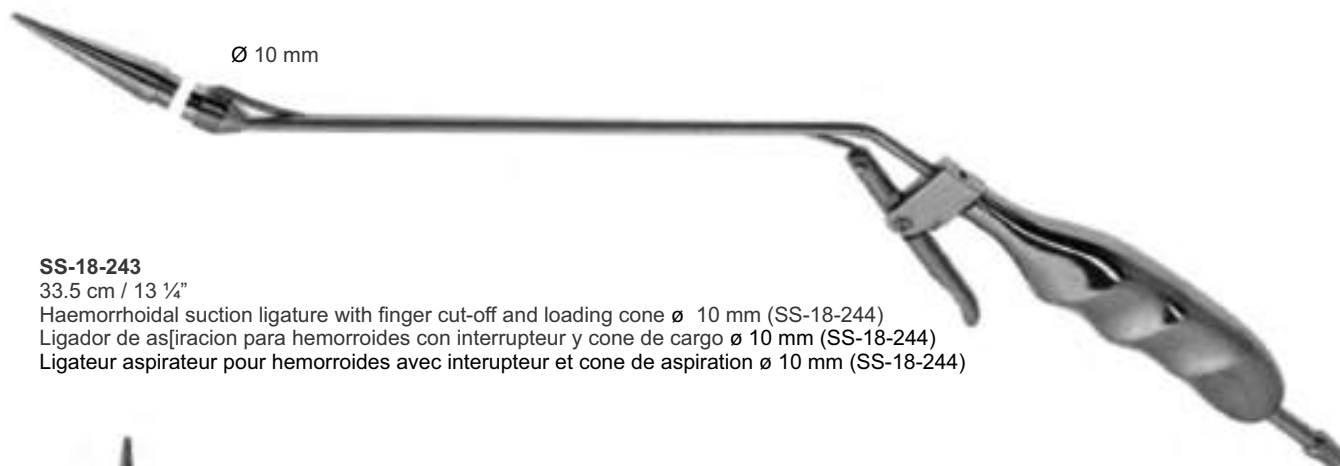

SS-18-243

33.5 cm / 13 1/4"

Haemorrhoidal suction ligature with finger cut-off and loading cone \varnothing 10 mm (SS-18-244)

Ligador de aspiracion para hemorroides con interruptor y cone de cargo \varnothing 10 mm (SS-18-244)

Ligateur aspirateur pour hemorroides avec interrupteur et cone de aspiration \varnothing 10 mm (SS-18-244)

1/2



SS-18-245

36.5 cm / 14 1/2"

Haemorrhoidal suction ligature with finger cut-off and loading cone \varnothing 8 mm (SS-18-246)

Ligador de aspiracion para hemorroides con interruptor y cone de cargo \varnothing 8 mm (SS-18-246)

Ligateur aspirateur pour hemorroides avec interrupteur et cone de aspiration \varnothing 8 mm (SS-18-246)

1/2

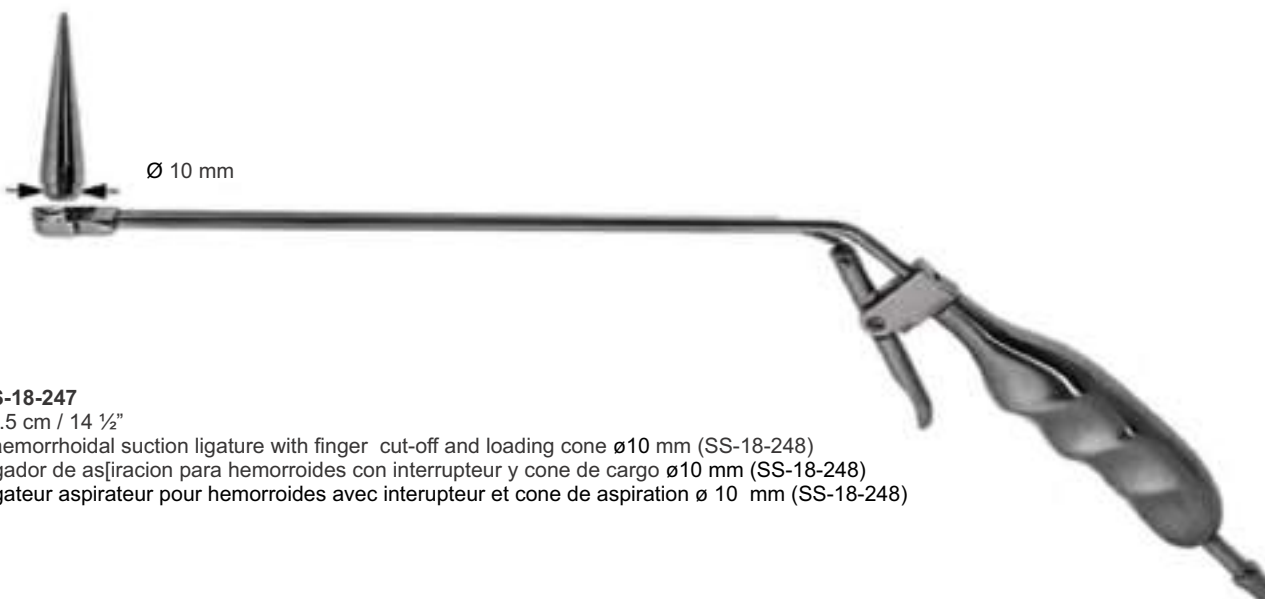

SS-18-247

36.5 cm / 14 1/2"

Haemorrhoidal suction ligature with finger cut-off and loading cone \varnothing 10 mm (SS-18-248)

Ligador de aspiracion para hemorroides con interruptor y cone de cargo \varnothing 10 mm (SS-18-248)

Ligateur aspirateur pour hemorroides avec interrupteur et cone de aspiration \varnothing 10 mm (SS-18-248)

1/2

Rectal Biopsy Specimen Forceps
Pinzas sacabocado para biopsia rectal
Pincas a biopsie rectale

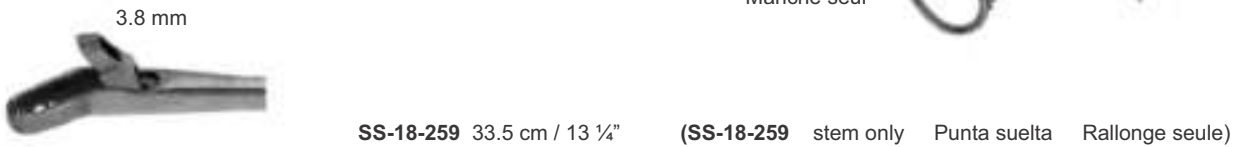
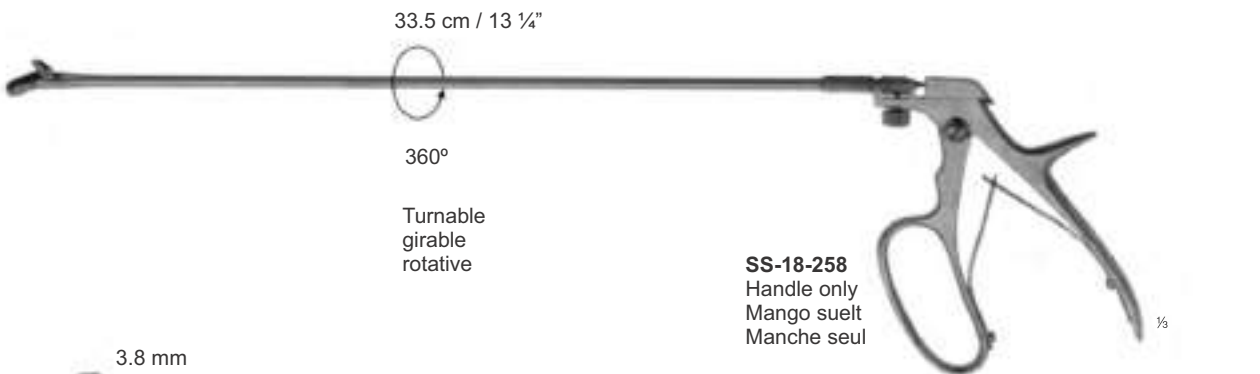
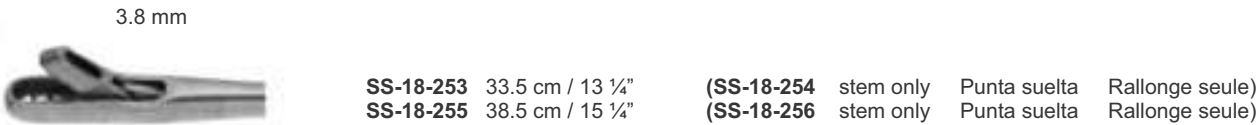
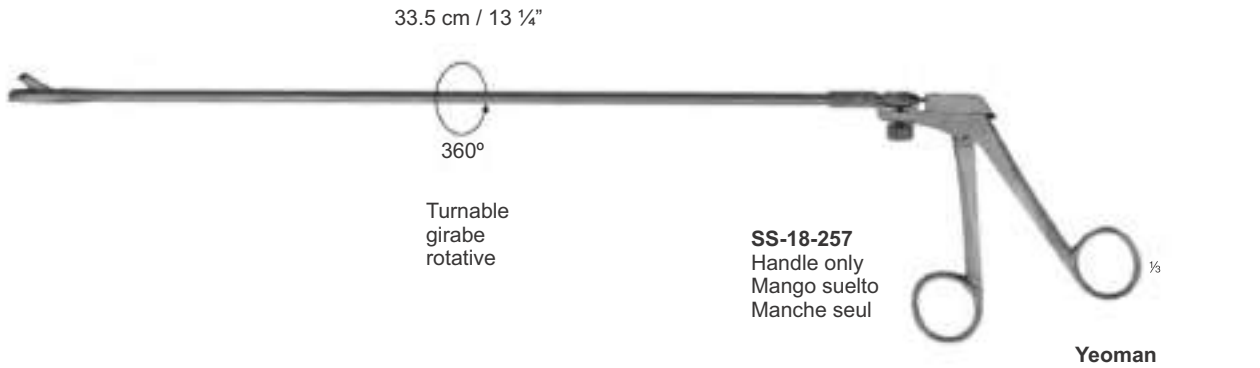
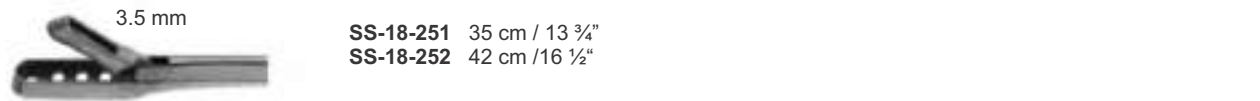
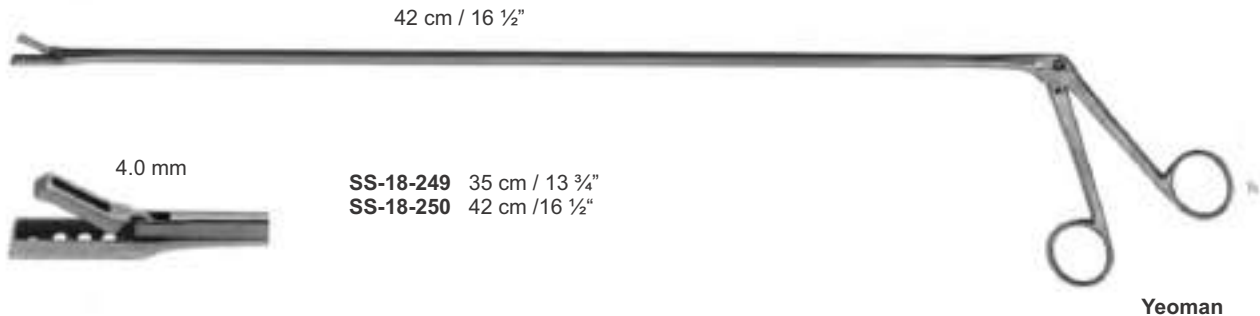



SAPTESTAR
Manufacturer & Exporter Of Surgical, Dental & Veterinary Instruments

Rectal Retractors
Separadores para el recto
Dilatateurs pour anus et rectum

12/20 x 70 mm



Ricord
SS-18-270
16 cm

16/10 x 70 mm

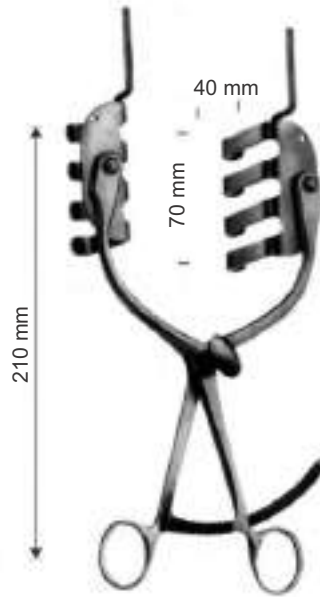

ST.Marks.Modif,Girona
SS-19-300
Perineal retractor with towel pegs
fitted to swivel rake blades

SS-18-275
(pair)
lateral blades
22 x 72 mm



SS-18-276
frame only

Park
SS-19-274



Hill-Ferguson
SS-18-280 7/8" wide
SS-18-281 1-3/16" wide
SS-18-282 1-7/16" wide
Rectal Retractor



Sawyer
SS-18-290 1" wide
SS-18-291 7/8" wide
SS-18-292 1-1/4" wide
Rectal Retractor

Max, Spread 115 mm



23 x 70 mm blade

Smith-Buie
SS-18-301



SAPTESTAR

Manufacturer & Exporter Of Surgical, Dental & Veterinary Instruments



+92-340-4040061



exportsaptestar@gmail.com



info@saptestar.com



www.saptestar.com



Defence Road, Near Hotel Javson, 51310-Sialkot Pakistan



Ophthalmology 19

-  +92-340-4040061
-  exportsaptestar@gmail.com
-  info@saptestar.com
-  www.saptestar.com
-  Defence Road, Near Hotel Javson, 51310-Sialkot Pakistan

Company Profile



ABOUT US

Quality begins at **SapteStar** Instruments Company where master craftsmen forge and manufacture each instrument to its exact specifications and measurements. Instruments must undergo a series of quality control inspections in order to be worthy of **SapteStar** name and warranty. We offer a wide selection of medical instruments including Surgical and Dental instruments.

We have acquired a unique and unmatched understanding of manufacturing through a large experience, working since 1908. Years of experience & state of the art manufacturing facilities helped us to keep our prices low. Our Surgical & Dental instruments are created by expert craftsmen, providing unfaltering quality you can rely on.

We have launched a fully interactive website where you can get online and track your orders 24 hours a day, 7 days in a week, and 365 days a year. Ask for our free e-catalogue on CD-Rom to save time and enjoy hassle free ordering.

We provide our customers with most reliable customer service as your satisfaction is our top priority. Our customers always enjoy our wonderful customer service and quality tools at the best price.

Lastly we invite you to have a work experience with SapteStar Instruments Company and we will prove ourselves as one of the most valuable source you have.

You can find us at

SapteStar
CEO



Company Profile



History

SAPTESTAR INSTRUMENTS was founded in 1995. Our Great Grandfather **Mian Muhammad Fazal Elahi** was the founder of M/s M.F. Elahi & Company (E.P.) Pvt. Ltd, established in 1908. SapteStar is a sister concern of M.F. Elahi & Co. It is our pride to be a member of M.F. Elahi Family.

SapteStar Instruments Company is located in the heart of beautiful city, Sialkot, Pakistan. We are manufacturers and exporters of quality Surgical, Dental instruments and Scissors of all sorts in various categories. We are closely attached with highly skilled surgeons and other technicians of the surgical industry to make the new instruments development possible.

SapteStar is in a continues process of development and testing of new instruments for their precision and perfect functioning. We are also working at imported forging supply by foreign customers.

Certificates

Instruments Company has achieved the certificates for ISO-9001, ISO-13485, cGMP (FDA) and CE Marking.

Quality Control

All material use in the manufacturing of our instruments are tested from relevant laboratories. Our continuous quality control is our best warranty so that you built confidence in our products.

Deliveries

Deliveries are quick and in-time.

Mode Of Payment

Terms of Payment is ADVANCE or LETTER OF CREDIT (Irrevocable)

Company Profile



Quality Policy

SapteStar Instruments Company aims to produce quality Surgical, Dental instruments and Scissors of all sorts at reasonable prices to become an exemplary manufacturer. Our total emphasize is to achieve customer's satisfaction by clearly understanding their requirements and following a quality management system which is a primary concern of all our work force. We do our best to produce instruments of finest quality.



Warranty

All SapteStar Instruments are produced from finest stainless steel available to be free from any defect in material or workmanship. Any product that proves to be defective in material or workmanship will either be repaired or replaced without any charge. This warranty is void if the instrument is abused, altered, modified or is not used in the manner for which it is intended.



Ophthalmology

19

19 Ophthalmology

Adjustable Wire	92	Corneal Epithelium Spatulae	93
Adventitia	62,64	Critchett	12
Aebli	58	Culler	22,27
Agricola	14	Curdy	80
Akahoshi Nucleus Sustainer	93	Daily	80
Alvis	81	Dastoor	50
Anderson-critchett	80	Datzin-barraquer	58
Arit	19,29	Daviel	19, 31
Arrowsmith	70,71	De La Roza	69
Arruga	01,02,13,19,25,45	Dermot Pierse (colibri)	55
Arruga-elschnig	45	Desmarres	15,67,79,80
Axenfeld	20,24,33,79	Deutschmann	16
Ayer	67	Deutschmith-green	75
Baird	67	Dilator Forcep	82
Bangerter	27,52	Direct Action Lens Implantation	90,91
Barkan	80	Dissection	62,64
Barraquer (colibri)	12	Dix	21,81
Barraquer Modif.	54	Elliot	38
Barraquer	02,05,48,49,56,61,68,80	Ellis	81
Barraquer-fino	28	Elschnig	22,28,44,46,48,68,79,80
Barraquer-katzin (colibri)	42	Fenzl Lens Manipulator	93
Barraquer-katzin	42	Fink	23
Barraquer-llovera	48,68	Fink-jameson	52
Barraquer-troutman	05	Fischer	38
Barrquer	87	Fischer-arlit	38
Becker	15	Foerster	36
Berens	18,52,53,75,76	Foreign Body With Magnifier	21
Berks	52	Francis	67,81
Binkhorst	45	Fuchs	41,44
Bishop-harman	39	Gass Muscle Hook	93
Blade Breaker	87	Gill	41,79
Blascovics	52	Gill-arruga	44
Bonaccolto	50	Gill-hess	41
Bonn	40	Gills-welsch	60
Bores	69,70,71,73	Graefe	11,12,15,17,18,19, 23, 25,31,36,37,47,74, 75,77,78,79
Bowman	11,12,77,81	Graefe-arruga	74
Bunge	20	Green	18,25,35,48
Burch	80	Gtaefe	19
Button Manipulator	93	Guthrie	23,80
Capulorhexis Notched	91	Guyton-lundsgaard	80
Capulorhexis	91	Haab	78
Castroviejo Corneal Scissor	85	Haefliger Phaco Cleaver	93
Castroviejo Corneal	86	Heath	33,67
Castroviejo	01,02,04,09,10,11,14,16,18, 22,26,28,35,46,47,49,56,58,61,68,76,86	Hebra	32
Castroviejo-barraquer	01, 22	Hepp-schedel	03
Castroviejo-colibri	43	Hess	19,31,38,44
Castroviejo-schachar	26	Hirschman	23
Cauer	53	Hirschmann	17
Chandler	41	Hoffer	72
Clayman	45	Hofmann-polack Corneal	92
Claymans Type Lol	90	Hunt	67
Colibri Suturing	89	Iris Scissors	86
Conjunctival	85	Incision Spreading Forcep	73
Connin-amsler	26	Jaboma	03
Connor Intracapsular Manipulator	94	Jacobi	69
Conway	15	Jacobson	09
Cook	13	Jaeger	11,25,75

19 Ophthalmology

Jaffe-berchert	30	Minami "m" Hook	93
Jaffe-blaydes	90	Mob. Barraquer	12
Jaffe-knolle Lris Hook	94	Mod. Bonn17,	17,39
Jameson	25,51	Mod. Hamaburg	77
Jeffe-knolle	17	Mod. Tuingen	17,54,77
Jerger-grieshaber	76	Moorfield	49
Johnson	78,80	Mueller	14
Johnson-took	79	Murdock	13
Kalt	46	Needle Holder	03,84,87
Kansas Nucleus Trisector	94	Needle Holders Porta-agujas	08-07
Kansas Nucleus Vectis	93	Needle	21
Katzin	57	Neuliann Nucleus Divider	94
Katzin Barraquer	58	Nicati	81
Kelman-mc Pherson	56,90	Nichamin Phaco	93
Kirby	34	Nightingale	33
Kirby-artur	42	Notched	88
Knapp	19,23,31,77	Noyes	59
Knapp-clark	12	Nugent	50
Knapp-rollet	24	O' Connor	17, 38
Knolle	17	Ong	59
Kremer	70	Papst	76
Kuhnt	78	Park Guyton	13
La Force (golf-club)	81	Park	13
Lambert	67	Park-guyton	11
Lancaster	11,12	Park-maumenee	11,13
Lang	20,33	Paton	79
Lens Implantation	90	Paufique	54
Lens Loop	94	Phaco Claw Chopper	93
Lens Nucleus Rotator	93	Pierse-colibri Corneal	88
Lester Lol Manipulator	94	Plange	81
Lester48,	48,68	Pley	12
Levinson	81	Polack Corneal	92
Lewicky Lens	94	Prince	51
Lewis	19,29	Razor Blade Holder	84
Lieberman Lasik Solid Speculum	92	Reill	06
Lindner	18,35	Rollet	23
Lister-burch	13	Round, Hollow Handle Forcep	82
Lol Forceps	90	Rowland	77
Lordan	53	Rubman-bores	70
Lris	86	Sato	78
Lundsgaaard	80	Sattler	51
Machat Lasik	92	Sauer Mob.martin	47
Maumenee-colibri	43	Sauer	14
Mc Cullough	51	Sautter	26
Mc Gannen18,	18,23	Scheie	80
Mc Pherson	54,88,89	Schmith-green	75
Mc Pherson-westcott Stitch	85	Schnaudigl	77
Mc Reynolds	80	Schweigger	44
Mellinger Beard	14	Schweiz. Mod.	81
Mellinger	13	Schwelgger	81
Mellinger-axenfeld	13	Scissors	83
Mellinger-beard	11	Searcy	80
Meyer-schwickerath	17	Shepard li	1145
Meyhoefer Hebra Bunge	20	Shepard	45
Meyhoefer	20,32	Sichel	78
Micro Scissor	63,65,66	Sinskey Lens Manipulating	94
Microintraocular Forcep	83	Sinskey	30
Microintraocular Scissor	83	Sinskey-cornic	30

19 Ophthalmology

Smith-fisher	18,35
Snellen	19,29,53
St. Martin	49
Stevens Needle Holder	84
Stevens	18,25,37
Stevenson	14
Stock	22,27,44
Suker	22,27
Suturing	89
Swiss Pattern	46
Synechiaie Spatula	94
Terson	44
Thornton	71
Took	79
Trouman	57
Troutman (colibri)	42
Troutman- Castroviejo	56-58
Troutman	06,19,29,49,87
Tubingen	40
Tying Forcep	88
Vannas Mod. Tubingen	60
Vannas	60,85,86
Walker-lee	80
Walton	81
Weber	19,29,77
Wecker	22,27,59,76,79
Weiss	11,12,31
Wessely-grieshaber	76
Westcott Stitch	85
Westcott Tenotomy	85
Wheeler	16,18,35,75
Wiener	17,18,76
Wies	67
Willard-colibri	43
Williams	13
Wire Speculum	92
Woodruff	69
Ziegler	12,78

Needle Holder
 Porta-agujas
 Porte-aiguilles



Castroviejo
 14 cm / 5 1/4"



SS-19-101



SS-19-102



Castroviejo
 14 cm / 5 1/4"



SS-19-103



SS-19-104



1/2

Arruga
 16 cm / 6 1/4"



SS-19-105



SS-19-106



1/2

Castroviejo
SS-19-107
 13 cm / 5 1/4"



1/2

Castroviejo-Barraquer
SS-19-108
 12 cm / 5 3/4"

Needle Holders with tungsten carbide edge
Porta-agujas T.C. Con filo de carbure tungsteno
Porte-aiguilles T.C. Avec des lames en tungstene





SAPTESTAR
Manufacturer & Exporter Of Surgical, Dental & Veterinary Instruments

Needle Holders with tungsten carbide edges
Porta-agujas T.C. Con filos de carbure tungsteno
Porte-aiguilles T.C. Avec des lames en tungstene



Webster
SS-19-115-1
13 cm / 5"



Crile-Wood
SS-19-115-2
15 cm / 6"

Mini profile
perfil mini
profil mini

With automatic release ratchet also for lefthanders
con cremallera automática también para zurdos
avec cremallere automatique aussi pour gauchers



SS-19-115-3
18 cm / 7"
with lock
con cierre
avec serrure

Micro profile
perfil micro
profil micro



Jaboma



SS-19-115-4
18 cm / 7"
smooth jaw
boca lisa
mors lisse

Hepp-Scheidel

Micro-Needle Holder with tungsten carbide edges
Micro-Porta-agujas T.C. Con filos de carbure tungsteno
Micro-Porte-aiguilles T.C. Avec des lames en tungstene



SS-19-115-5
14.5 cm / 5¾"
With lock
con cierre
avec serrure

Micro profile
perfil micro
profil micro



SS-19-115-6
14.5 cm / 5¾"
With lock
con cierre
avec serrure

Micro profile
perfil micro
profil micro



SS-19-115-7
14.5 cm / 5¾"
smooth jaw
boca lisa
mors lisse



SS-19-115-8
18 cm / 7"
With lock
con cierre
avec serrure

Micro profile
perfil micro
profil micro



SS-19-115-9
21.5 cm / 8½"
With lock
con cierre
avec serrure

Micro profile
perfil micro
profil micro



Castroviejo



SS-19-115-10
14.5 cm / 5¾"
smooth jaw
boca lisa
mors lisse



SS-19-115-11
18 cm / 7"
With lock
con cierre
avec serrure

Micro profile
perfil micro
profil micro



SS-19-115-12
21.5 cm / 8½"
With lock
con cierre
avec serrure

Micro profile
perfil micro
profil micro

Needle Holders
 Porta-agujas
 Porte-aiguilles



**Barraquer-Troutman
 SS-19-116**
 10 cm / 4"



**Barraquer-Troutman
 SS-19-117**
 10 cm / 4"



**Barraquer-Troutman
 SS-19-118**
 10 cm / 4"



**Barraquer-Troutman
 SS-19-119**
 10 cm / 4"



**Barraquer
 SS-19-120**
 11 cm / 4 1/4"



**Barraquer
 SS-19-121**
 13 cm / 5"



**Barraquer
 SS-19-122**
 14 cm / 5 1/2"



**Barraquer
 SS-19-123**
 14 cm / 5 1/2"



**Barraquer
 SS-19-124**
 14 cm / 5 1/2"

Needle Holders
 Porta-agujas
 Porte-aiguilles



Troutman
SS-19-125
 12 cm / 4¾"



Troutman
SS-19-126
 12 cm / 2¾"



SS-19-127



SS-19-129



Reill
 15 cm / 6"

Reill
 15 cm / 6"

Needle Holders
Porta-agujas
Porte-aiguilles



SS-119-131
14 cm / 5 1/2"



SS-119-132
14 cm / 5 1/2"
for right handed surgeons

Jaws concave/convex



SS-119-133
14 cm / 5 1/2"
for left handed surgeons



SS-19-134
18 cm / 7 1/4"



SS-19-135
18 cm / 7 1/4"



SS-19-136
18 cm / 7 1/4"



SS-19-137
18 cm / 7 1/4"

Needle Holders
 Porta-agujas
 Porte-aiguilles

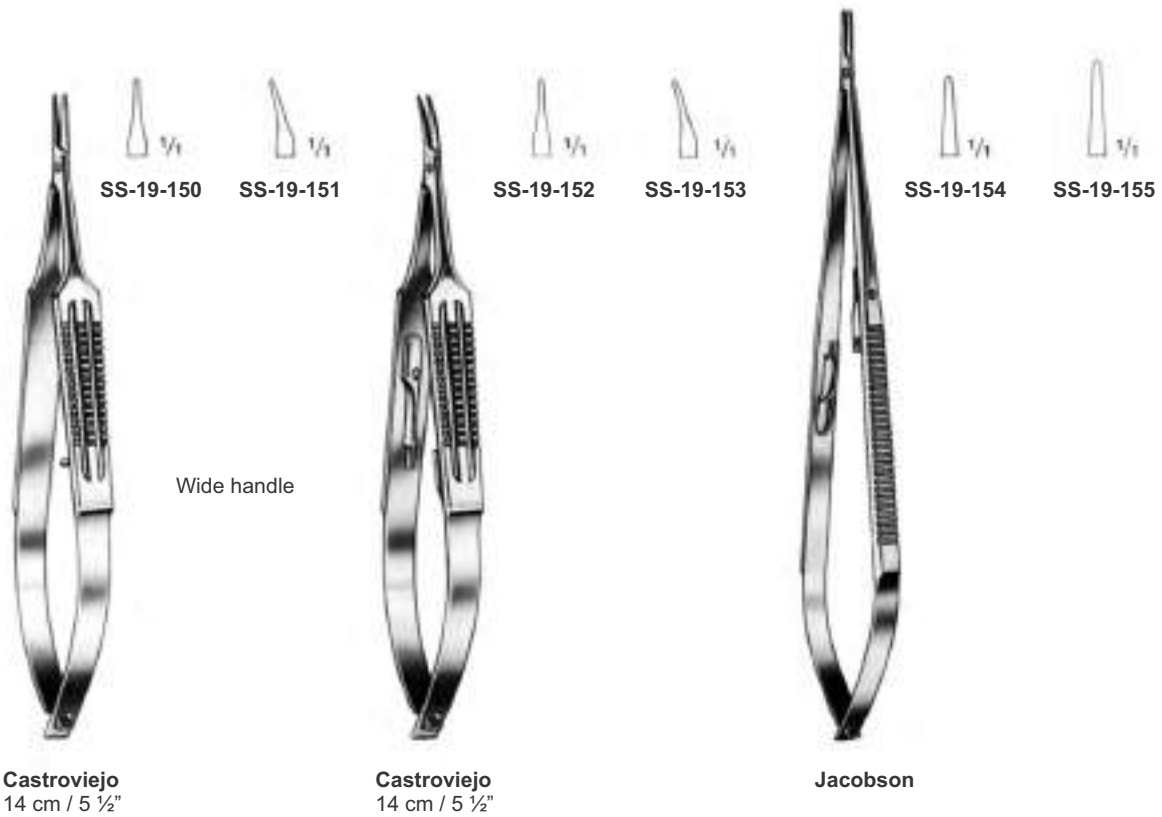
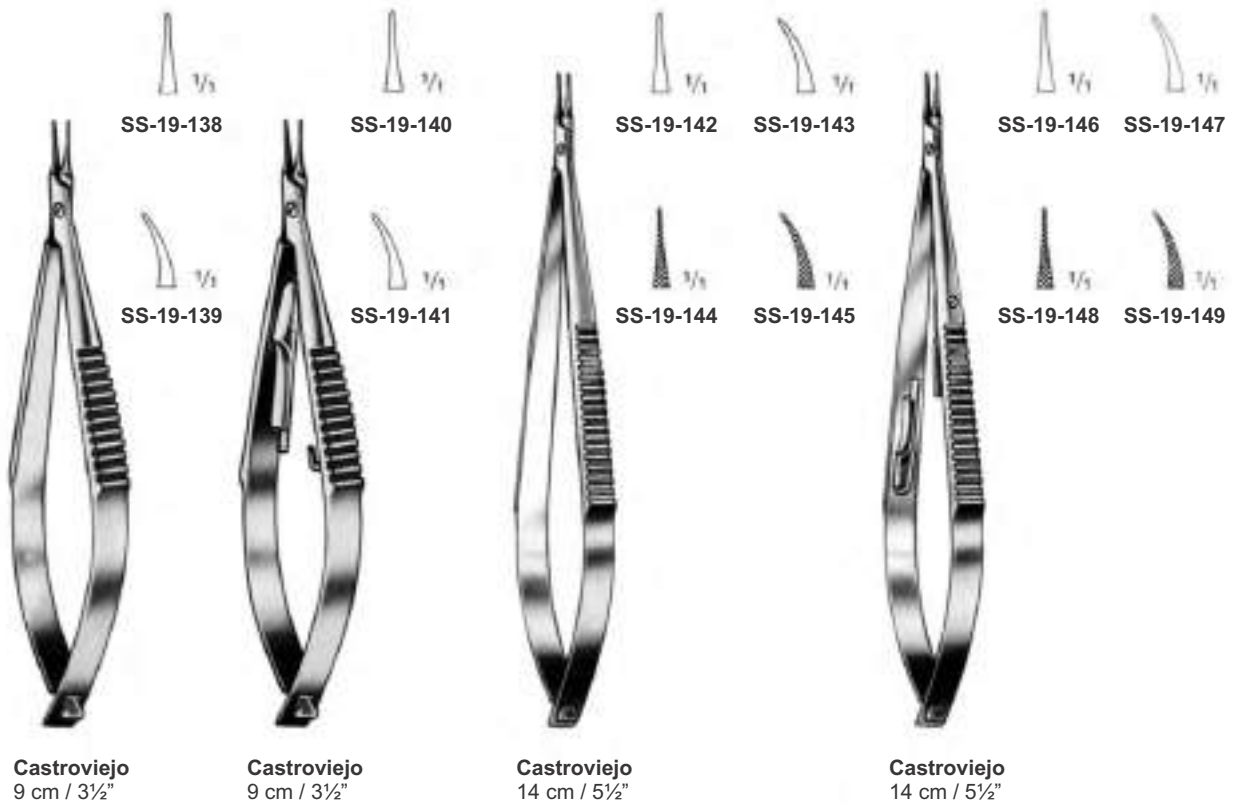

Needle Holders
Porta-agujas
Porte-aiguilles



SS-19-156



SS-19-157



Castroviejo
13 cm / 5 1/4"
Handle 8 mm ø

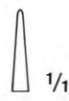

SS-19-158



SS-19-159



Castroviejo
13 cm / 5 1/4"
Handle 8 mm ø

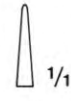

SS-19-160



SS-19-161



Castroviejo
13 cm / 5 1/4"
Handle 10 mm ø

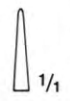

SS-19-162



SS-19-163



Castroviejo
13 cm / 5 1/4"
Handle 10 mm ø

Eye Specula
Blefarostatos
Blepharostats

Eye Specula . Blefarostatos . Blépharostats



½

Bowman
SS-19-164
7 cm / 2¾"



Graefe
SS-19-165
7 cm / 2¾"



½

Weiss
SS-19-166
8 cm / 3¼"



½

Lancaster
SS-19-167
8 cm / 3¼"



½

Park-Guyton
SS-19-168
8 cm / 3¼"



½

Park-Maumenee
SS-19-169
8 cm / 3¼"



½

Mellinger-Beard
SS-19-170
5 cm / 2"
SS-19-171
7 cm / 2¾"



½

Castroviejo
SS-19-172
8 cm / 3¼"



½

Jaeger
SS-19-173
11 cm / 4½"

Lid Plate
Placa para párpados
Plaque a paupieres

Eye Specula
Blefarostatos
Blepharostats



Barraquer (Colibri)
SS-19-174 **SS-19-175**
3 cm / 1¼" 4 cm / 1½"
children adults



Mod. Barraquer
SS-19-176
4 cm / 1½"



Bowman
SS-19-177
7 cm / 2¾"

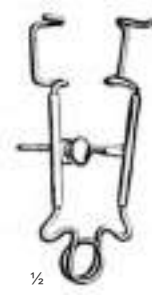

Critchett
SS-19-178
7 cm / 2¾"



Graefe **Graefe**
SS-19-179 **SS-19-180**
7 cm / 2¾" 9 cm / 3½"
Children adults



Pley
SS-19-181
6 cm / 2½"



Ziegler
SS-19-182
7 cm / 2¾"



Knapp-Clark
SS-19-183
8 cm / 3¼"



Lancaster
SS-19-184
8 cm / 3¼"



Weiss **Weiss**
SS-19-185 **SS-19-186**
7 cm / 2¾" 9 cm / 3½"
Children adults



Weiss **Weiss**
SS-19-187 **SS-19-188**
7 cm / 2¾" 9 cm / 3½"
Children adults



Weiss
SS-19-189
8 cm / 3¼"



SAPTESTAR
Manufacturer & Exporter Of Surgical, Dental & Veterinary Instruments

Eye Specula
Blefarostatos
Blepharostats



1/2

Lister-Burch
SS-19-190
8 cm / 3 1/4"



Williams **Williams**
SS-19-191 **SS-19-192**
7 cm / 2 3/4" 8 cm / 3 1/4"
children adults



1/2

Park
SS-19-193
8 cm / 3 1/4"



1/2

Park Guyton
SS-19-194
8 cm / 3 1/4"



1/2

Park-Maumenee
SS-19-195
8 cm / 3 1/4"



1/2

Arruga
SS-19-196
7 cm / 2 3/4"
for left eye



1/2

Arruga
SS-19-197
7 cm / 2 3/4"
for right eye



1/2

Murdock
SS-19-198
5 cm / 2"



1/2

Cook **Cook**
SS-19-199 **SS-19-200**
4 cm / 1 1/2" 5 cm / 2"
children adults



1/2

Mellinger **Mellinger**
SS-19-201 **SS-19-202**
5 cm / 2" 7 cm / 2 3/4"
children adult



1/2

Mellinger-Axenfeld
SS-19-203
7 cm / 2 3/4"



1/2

Mellinger-Axenfeld
SS-19-204
7 cm / 2 3/4"

Eye Specula
 Blefarostatos
 Blepharostats



Mellinger beard
SS-19-205 **SS-19-206**
 5 cm / 2" 7 cm / 2¾"
 Children adult



Sauer
SS-19-207
 3 cm / 1¼"



Castroviejo
SS-19-208
 8 cm / 3¼"



Stevenson
SS-19-209
 7 cm / 2¾"



Mueller
SS-19-210
 7 cm / 2¾"



Agricola
SS-19-211
 4 cm / 1½"



SAPTESTAR
Manufacturer & Exporter Of Surgical, Dental & Veterinary Instruments

Lid Instruments, Cystotomes
Instrumentos para parpaods, quistotomos
Instruments a paupieres, kystitomes

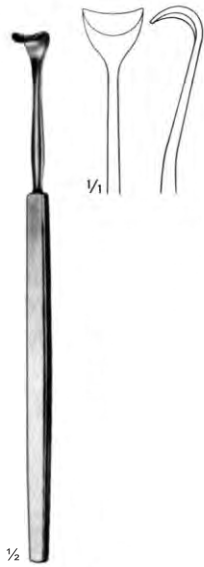

Conway
SS-19-212
13 cm / 5"



Desmarres
SS-19-213
13 cm / 5"



Desmarres
13 cm / 5"



SS-19-214



SS-19-215



SS-19-216



SS-19-217



1/2



SS-19-218



SS-19-219



SS-19-220

Graefe
13 cm / 5"



Becker
SS-19-221
13 cm / 5"

Discission Knives
 Glaucoma y discisiones
 A glaucome et a discisions



Deutschmann
SS-19-222
 13 cm / 5"



Wheeler
SS-19-223
 12 cm / 4½"



Castroviejo
SS-19-224
 9 cm / 3½"



Castroviejo
SS-19-225
 9 cm / 3½"



Castroviejo
SS-19-226
 9 cm / 3½"

Cystotomes, Hooklets, Localizer
 Quistotomos, ganchitos, localiz
 Kystitomes, crochets, localisateur

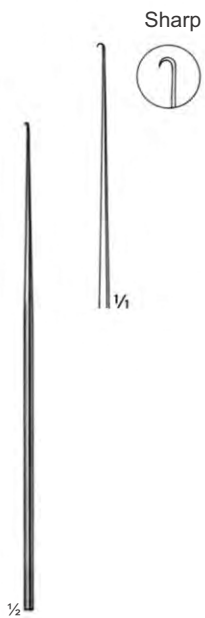

Mod. Tübingen
SS-19-227
 14 cm / 5 2/3"



Mod. Bonn
SS-19-228
 14 cm / 5 2/3"



Hirschmann
SS-19-229
 10 cm / 4"

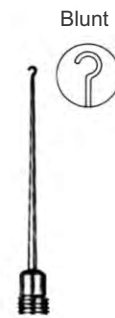

Knolle
SS-19-230
 13 cm / 5"



Jeffe-knolle
SS-19-231
 13 cm / 5"



Graefe
SS-19-232
 12 cm / 4 3/4"



Graefe
SS-19-233
 12 cm / 4 3/4"



Meyer-Schwickerath
SS-19-234
 13 cm / 5"



O'Conner
SS-19-235
 12 cm / 4 3/4"



Wiener
SS-19-236
 13 cm / 5"



Wiener
SS-19-237
 13 cm / 5"

Hooks, Spatulas
Ganchitos, Espatula
Divers, Spatule

Various Hooks



Iris Hook

Iris Retractor

Sclera Hook

Extraction Hook

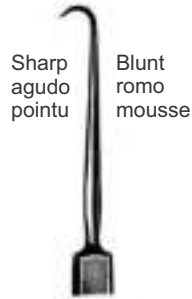

Sharp agudo pointu
Blunt romo mousse



Graefe
SS-19-240
13 cm / 5"

McGannan
SS-19-241
13 cm / 5"



Sharp agudo pointu

Berens
SS-19-242
12 cm / 4¾"



Sharp agudo pointu

Stevens
SS-19-243
12 cm / 4¾"

Wiener
SS-19-238 13 cm / 5"
SS-19-239 13 cm / 5"

Cyclodialysis Spatulas

Cyclodialysis Spatulas and Spoon, graduated

Iris spatula

Double spatula



Width of spatula
mm
SS-19-244 0.50
SS-19-245 0.75
SS-19-246 1.00

Castroviejo
14 cm / 5½"



Castroviejo
SS-19-247
12 cm / 4¾"



Wheeler
SS-19-248
12 cm / 4¾"



Lindner
SS-19-249
13 cm / 5"



Smith-Fisher
SS-19-250
12 cm / 4¾"



Green
SS-19-251
12 cm / 4¾"



SAPTESTAR
Manufacturer & Exporter Of Surgical, Dental & Veterinary Instruments

Lens Expressor, Lens Loops
Expresor para el cristalino, Asas
Expresseur pour la lentille cristalline, Anses



Cataract Spoons



Chalazion Curettes, Lachrymal Sac Dissector



Meyhoefer



Hebra

Chalazion Curettes, Lachrymal Sac Dissector
double-ended, sharp



Axenfeld
SS-19-285
13 cm / 5"

Lang
SS-19-286
13 cm / 5"

Evisceration Spoons



Bunge

Meyhoefer
Hebra
Bunge

Double Ended Instruments
 Instruments dobles
 Instruments doubles

Needle and spud, in round sliding handle

Needle and Gouge, in round sliding handle



Dix
SS-19-287
 12 cm / 4 3/4"

Dix
SS-19-288
 12 cm / 4 3/4"

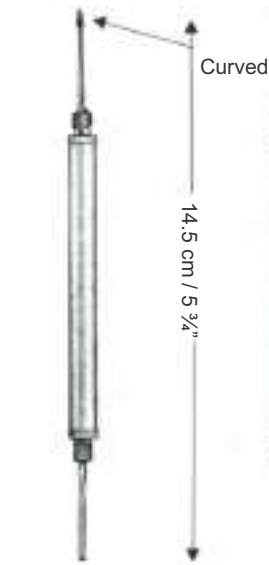

Dix
SS-19-289
 12 cm / 5 3/4"

Dix
SS-19-290
 12 cm / 5 3/4"

Curved



SS-19-291
 Needle only

SS-19-292
 Spud only

SS-19-293
 Gouge only

Needles and Spud, in reversible screw-handle

Foreign Body remover and Magnetic Eye probe in reversible handle



1/2

SS-19-294
 17 cm / 6 3/4"

SS-19-295
 17 cm / 6 3/4"

With magnifier

Iris Spatulas, Cyclodialysis Spatulas
Espatulas para iris, espatulas para ciclodialisis
Spatules pour l'iris, spatules pour cyclodialyse

Various Spatulas



Iris Spatulas



Wecker
SS-19-300
13 cm / 5"



Wecker
SS-19-301
13 cm / 5"



Stock
SS-19-302
13 cm / 5"



Culler
SS-19-303
13 cm / 5"



Suker
SS-19-304
14 cm / 5½"

Cyclodialysis Spatulas

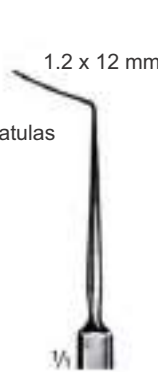

Elsching
SS-19-305
13 cm / 5"



Castroviejo
SS-19-306
13 cm / 5"



Castroviejo
SS-19-307
14 cm / 5½"

Width of spatula

0.5 mm 1.0 mm

SS-19-308

SS-19-314

8 mm

SS-19-309

SS-19-315

10 mm

SS-19-310

SS-19-316

12 mm

SS-19-311

SS-19-317

14 mm

SS-19-312

SS-19-318

16 mm

SS-19-313

SS-19-319

18 mm



Castroviejo-Barraquer
Cyclodialysis Spatula



Castroviejo-Barraquer
Cyclodialysis Spatula

Hooklets, Localizer, Fixation, Claws, Hooks
 Gamchitos, localiz, garras fijadoras, ganchitos
 Crochets, localisateur, griffes a fixation, crochets



Fixation, Claws, Hooks
Garras fijadoras, ganchitos
Griffes a fixation, crochets



SS-19-329



SS-19-330



SS-19-331

Knapp-Rollet
Flexible, sharp



SS-19-332
Sharp



SS-19-333
blunt



SS-19-334
Sharp



SS-19-335
blunt

Axenfeld

Hooks, Hooklets
 Ganchos y Ganchitos
 Ecarteurs et Crochets

Protector insulated



Arruga
 SS-19-336



Arruga
 SS-19-337



Stevens
 SS-19-338



Stevens
 SS-19-339



Jameson
 SS-19-340



Green
 SS-19-341



Graefe
 SS-19-342



Graefe
 SS-19-343



Graefe
 SS-19-344



Jaeger
 SS-19-345



Jaeger
 SS-19-346



Arruga
 SS-19-347
 left



Arruga
 SS-19-348
 right

Spatulas, Markers
 Espatulas, Marcadores
 Spatule, Marqueurs



Sautter
SS-19-349
 14.5 cm / 5 3/4"



Sautter
SS-19-350
 14.5 cm / 5 3/4"



Sautter
SS-19-351
 14.5 cm / 5 3/4"



Measuring Range: 15 mm



Castroviejo
SS-19-352

Measuring Range: 20 mm



Castroviejo
SS-19-353

Measuring Range: 20 mm



Castroviejo-Schachar
SS-19-354



Connin-Amsler
SS-19-355

Cyclodialysis Spatulas
 Espatulas para ciclodialis
 Spatule a Cyclodialyse



Wecker
 SS-19-356

Wecker
 SS-19-357

Stock
 SS-19-358

Culler
 SS-19-359

½

½



Culler
 SS-19-360

Suker
 SS-19-361

Bangerter

SS-19-362
 6 mm

SS-19-363
 10 mm

SS-19-364
 12 mm

½

Cyclodialysis Spatulas
 Espatulas para ciclodialisis
 Spatule a Cyclodialyse

1.2 x 12 mm
 $\frac{1}{16}$



Elschnig
 SS-19-365

0.25 x 12 mm
 $\frac{1}{16}$



Barraquer-Fino
 SS-19-366

1.2 x 10 mm
 $\frac{1}{16}$



Castroviejo
 SS-19-367

1.5 x 15 mm
 $\frac{1}{16}$



Castroviejo
 SS-19-368



0.8 x 15 mm
 $\frac{1}{16}$



Castroviejo
 SS-19-369
 9 cm / 3½"



Castroviejo
 SS-19-370
 9.5 cm / 3¾"

Lens Scoops
Asas
Anses



Troutman
SS-19-371
13 cm / 5¼"

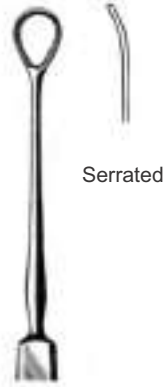

Lewis
SS-19-372



Lewis
SS-19-373



Weber
SS-19-374



Weber
SS-19-375



Snellen
SS-19-376



Art



SS-19-377
Smooth



SS-19-378
Serrated



Sinskey
SS-19-379
13 cm / 5"



Sinskey-Cornic
SS-19-380
13 cm / 5"



Sinskey
SS-19-381
13 cm / 5"



Jaffe-Berchert
SS-19-382
11 cm / 4½"

Lens Expressors, Eye Spoons
Expresores para el cristalino, Varias cucharillas
Expresseurs a lentille cristalline, spatulas



Hess
SS-19-383



Graefe
SS-19-384



Graefe
SS-19-385



Daviel
SS-19-386



Daviel
SS-19-387



$\frac{1}{2}$
13 cm / 5"



Knapp
SS-19-388



Wells
SS-19-389
small



Wells
SS-19-390
large

Chalazion Curettes
Cucharillas para chalazion
Curettes tranchantes a chalazion



SS-19-391
0.5 mm \varnothing



SS-19-392
1.0 mm \varnothing



SS-19-393
1.5 mm \varnothing



SS-19-394
1.8 mm \varnothing



SS-19-395
2.0 mm \varnothing



SS-19-396
2.5 mm \varnothing



SS-19-397
3.5 mm \varnothing



SS-19-398
4.0 mm \varnothing



SS-19-399
4.5 mm \varnothing

Meyhoefer



SS-19-400
1.0 mm \varnothing



SS-19-401
2.0 mm \varnothing



SS-19-402
2.5 mm \varnothing



SS-19-403
3.0 mm \varnothing



SS-19-404
3.5 mm \varnothing

Hebra

Chalazion Currettes, Dissectors
 Chucharillas para chalazion, disecadores
 Currettes a chalazion, dissecteurs

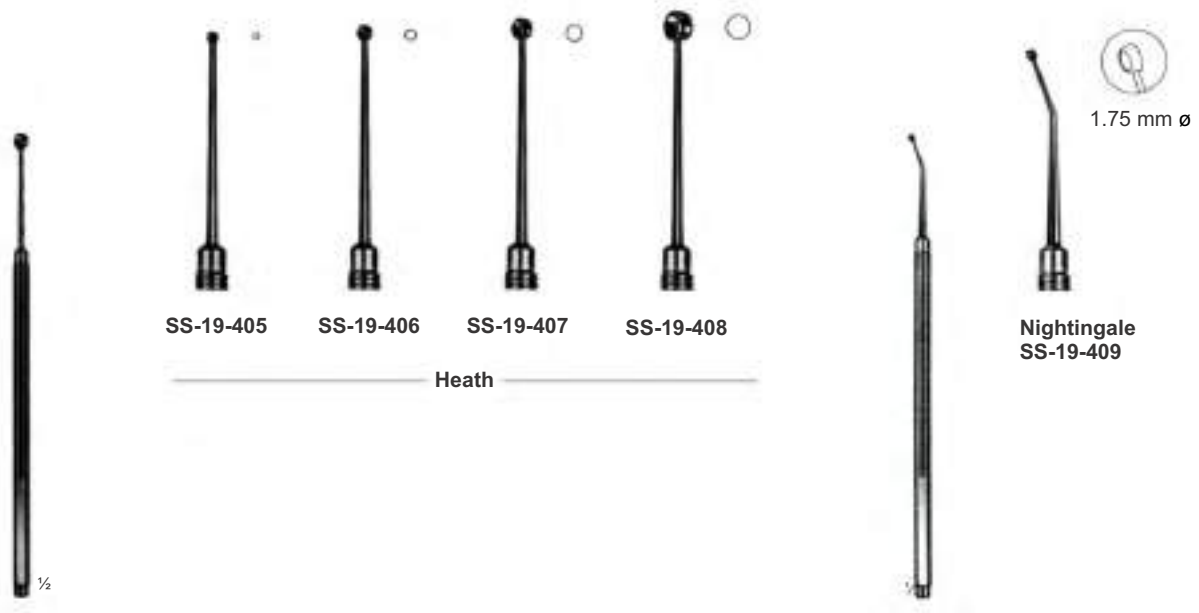

Axenfeld
 SS-19-410



Lang
 SS-19-411

Instruments by D. B. Kirby
 Cataratas seg, D. B. Kirby
 Cataracte selon D. B. Kirby



Kirby
SS-19-415
10 cm / 4"



Kirby
SS-19-416
10 cm / 4"



Kirby
SS-19-417
10 cm / 4"

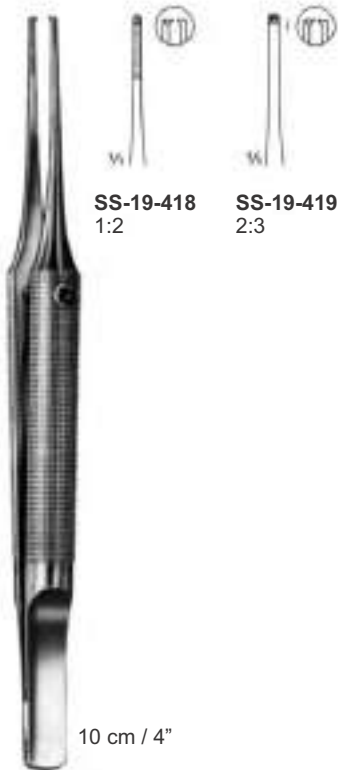

SS-19-418
1:2

SS-19-419
2:3

10 cm / 4"



SS-19-420
10 cm / 4"



SS-19-421
10 cm / 4"



SS-19-422
10 cm / 4"

Double-ended Instruments
 Instruments dobles
 Instruments doubles



Iris Forceps, Conjunctival Forceps
Pinzas para Iris, Pinzas conjuntival
Pincas a iris, Pincas conjuntival

Without teeth



Foerster
SS-19-431
8.5 cm / 3½"

With 1:2 teeth



Foerster
SS-19-432
8.5 cm / 3½"



Foerster
SS-19-433
8.5 cm / 3½"



Foerster
SS-19-434
8.5 cm / 3½"



Graefe
SS-19-435 0.5 mm
SS-19-436 0.7 mm
SS-19-437 1.0 mm
7 cm / 2¾"



Graefe
SS-19-438 0.5 mm
SS-19-439 0.7 mm
SS-19-440 1.0 mm
7 cm / 2¾"



Graefe
SS-19-441 0.5 mm
SS-19-442 0.7 mm
SS-19-443 1.0 mm
7 cm / 2¾"



Graefe
SS-19-444 0.5 mm
SS-19-445 0.7 mm
SS-19-446 1.0 mm
7 cm / 2¾"

Iris Forceps
 Pinzas para Iris
 Pincas a iris



Graefe
SS-19-447
 10 cm / 4"



Graefe
SS-19-448
 10 cm / 4"



Graefe
SS-19-449
 10 cm / 4"



Graefe
SS-19-450
 10 cm / 4"



Graefe
SS-19-451
 10 cm / 4"



Graefe
SS-19-452
 10 cm / 4"



Stevens
SS-19-453
 10.5 cm / 4½"



Stevens
SS-19-454
 10.5 cm / 4½"



Stevens
SS-19-455
 10.5 cm / 4½"



Stevens
SS-19-456
 10.5 cm / 4½"



Stevens
SS-19-457
 10.5 cm / 4½"



Stevens
SS-19-458
 10.5 cm / 4½"

Illustration, Iris Forceps
Ilustración, Pinzas para iris,
Illustration, Pincas a iris



Elliot
SS-19-459
10 cm / 4"



Fischer
SS-19-460
7 cm / 2 3/4"



Fischer-Arnt
SS-19-461
7 cm / 2 3/4"



Hess
SS-19-462
7 cm / 2 3/4"



Hess
SS-19-463
7 cm / 2 3/4"



Conjunctival Forceps

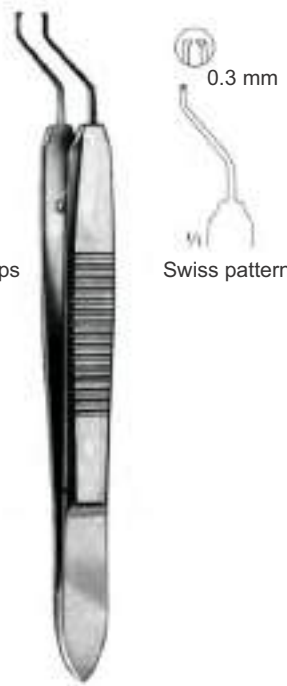

Hess
SS-19-465
9 cm / 3 1/2"



Hess
SS-19-466
9 cm / 3 1/2"



SAPTESTAR
Manufacturer & Exporter Of Surgical, Dental & Veterinary Instruments

Iris Forceps, Fixation Forceps
Pinzas para Iris, Pinzas de fijacion
Pinces a iris, pinces a fixer

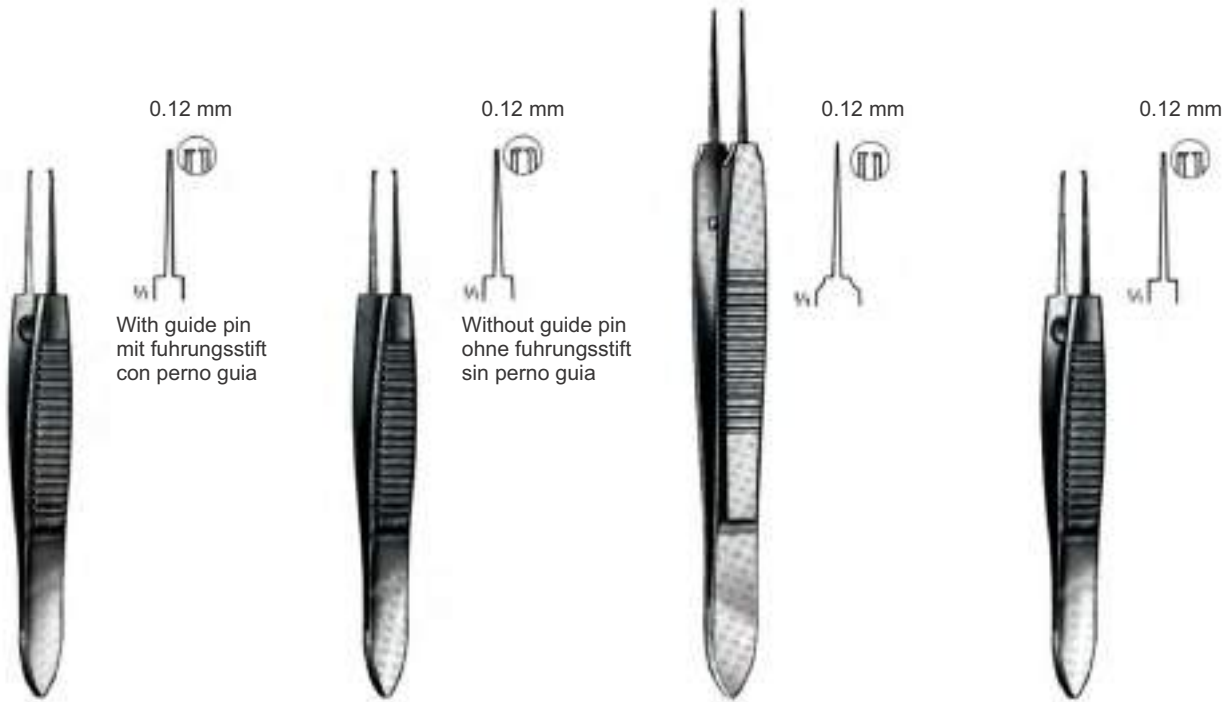

Mod.Bonn
SS-19-467
7 cm / 2¾"

Mod.Bonn
SS-19-468
7 cm / 2¾"

Mod.Bonn
SS-19-469
10 cm / 4"

Mod.Bonn
SS-19-470
7 cm / 2¾"

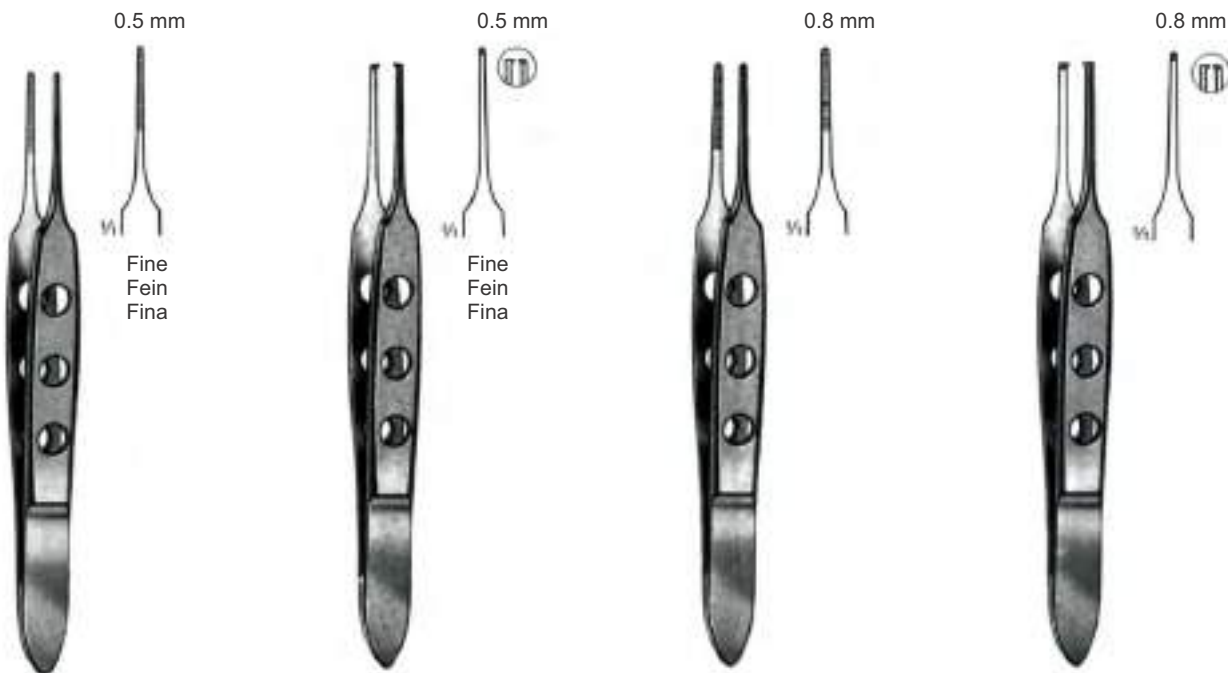

Bishop-Harman
SS-19-471
8.5 cm / 3½"

Bishop-Harman
SS-19-472
8.5 cm / 3½"

Bishop-Harman
SS-19-473
8.5 cm / 3½"

Bishop-Harman
SS-19-474
8.5 cm / 3½"

Suture Forceps
Pinzas para sutura
Pincas a sutures



Tübingen
SS-19-475
10 cm / 4"

0.12 mm



Bonn
SS-19-476
10 cm / 4"



Tubingen
SS-19-477
10 cm / 4"



SAPTESTAR
Manufacturer & Exporter Of Surgical, Dental & Veterinary Instruments

Iris Forceps, Fixation Forceps
Pinzas para Iris, Pinzas de fijacion
Pincas a iris, pincas a fixer



Chandler
SS-19-478
7 cm / 2¾"



Chandler
SS-19-479
7 cm / 2¾"



Fuche
SS-19-480
7 cm / 2¾"



Gill
SS-19-481
7.5 cm / 3"



Gill-Hess
SS-19-482
7.5 cm / 3"



Gill-Hess
SS-19-483
7.5 cm / 3"

Iris Forceps, Fixation Forceps
Pinzas para Iris, Pinzas de fijacion
Pinces a iris, pinces a fixer



Barraquer-Katzin
SS-19-484
7 cm / 2¾"



Troutman (Colibri)
SS-19-485
7.5 cm / 3"



Barraquer (Colibri)
SS-19-486
7 cm / 2¾"



Barraquer-Katzin (Colibri)
SS-19-487
7 cm / 2¾"



Barraquer (Colibri)
SS-19-488
7 cm / 2¾"



Kirby-Artur
SS-19-489
9 cm / 3½"



Kirby-Artur
SS-19-490
9 cm / 3½"

Iris Forceps, Fixation Forceps
Pinzas para Iris, Pinzas de fijacion
Pinces a iris, pinces a fixer



Castroviejo-Colibri
SS-19-491
10 cm / 4"



Mauensee-Colibri
SS-19-492
10 cm / 4"



Willard-Colibri
SS-19-493
13 cm / 5 1/4"

Capsular Forceps
Pinzas capsulares
Pincers capsulaires



Gill-Arruga
SS-19-494
7.5 cm / 3"



Terson
SS-19-495
9 cm / 3½"



Schweigger
SS-19-496
10 cm / 4"



Schweigger
SS-19-497
10 cm / 4"



Stock
SS-19-498
9.5 cm / 3¾"



Elschnig
SS-19-499
10 cm / 4"



Hess
SS-19-500
6 cm / 2½"



Hess
SS-19-501
6.5 cm / 2½"



Fuchs
SS-19-502
7 cm / 2¾"



Terson
SS-19-503
9.5 cm / 3¾"

Capsular Forceps
 Pinzas capsulares
 Pincas capsulaires



Arruga
SS-19-504
 10 cm / 4"



Calibrated

Arruga
SS-19-505
 10 cm / 4"



Arruga
SS-19-506
 10 cm / 4"



Calibrated

Arruga-Elschnig
SS-19-507
 10 cm / 4"



Binkhorst
SS-19-508
 7 cm / 2¾"



Clayman
SS-19-509
 with irrigator

SS-19-510
 Without irrigator



Shepard
SS-19-511
 with irrigator

SS-19-512
 Without irrigator



Shepard II
SS-19-513
 with irrigator

SS-19-514
 Without irrigator

Capsular Forceps
Pinzas capsulares
Pincers capsulaires



Kalt
SS-19-515
10 cm / 4"



Kalt
SS-19-516
10 cm / 4"

Calibrated



Castroviejo
SS-19-517
10 cm / 4"



Castroviejo
SS-19-518
10 cm / 4"



Elschnig
SS-19-519
10 cm / 4"



Swiss pattern
SS-19-520
9 cm / 3 1/2"



SAPTESTAR
Manufacturer & Exporter Of Surgical, Dental & Veterinary Instruments

Fixation Forceps, Tissue Forceps
Pinzas de fijacion, Pinzas con dientes
Pincas a fixer, Pincas a griffes



SS-19-521
without spring catch



SS-19-522
with spring catch

Graefe
11 cm / 4½"

0.3 mm



**Sauer
Mod. Martin
SS-19-523**
7.5 cm / 3"

0.3 mm



**Sauer
Mod. Martin
SS-19-524**
7.5 cm / 3"



**Castroviejo
SS-19-525**
9 cm / 3½"



**Castroviejo
SS-19-526**
9 cm / 3½"



**Castroviejo
SS-19-527**
9 cm / 3½"



**Castroviejo
SS-19-528**
9 cm / 3½"

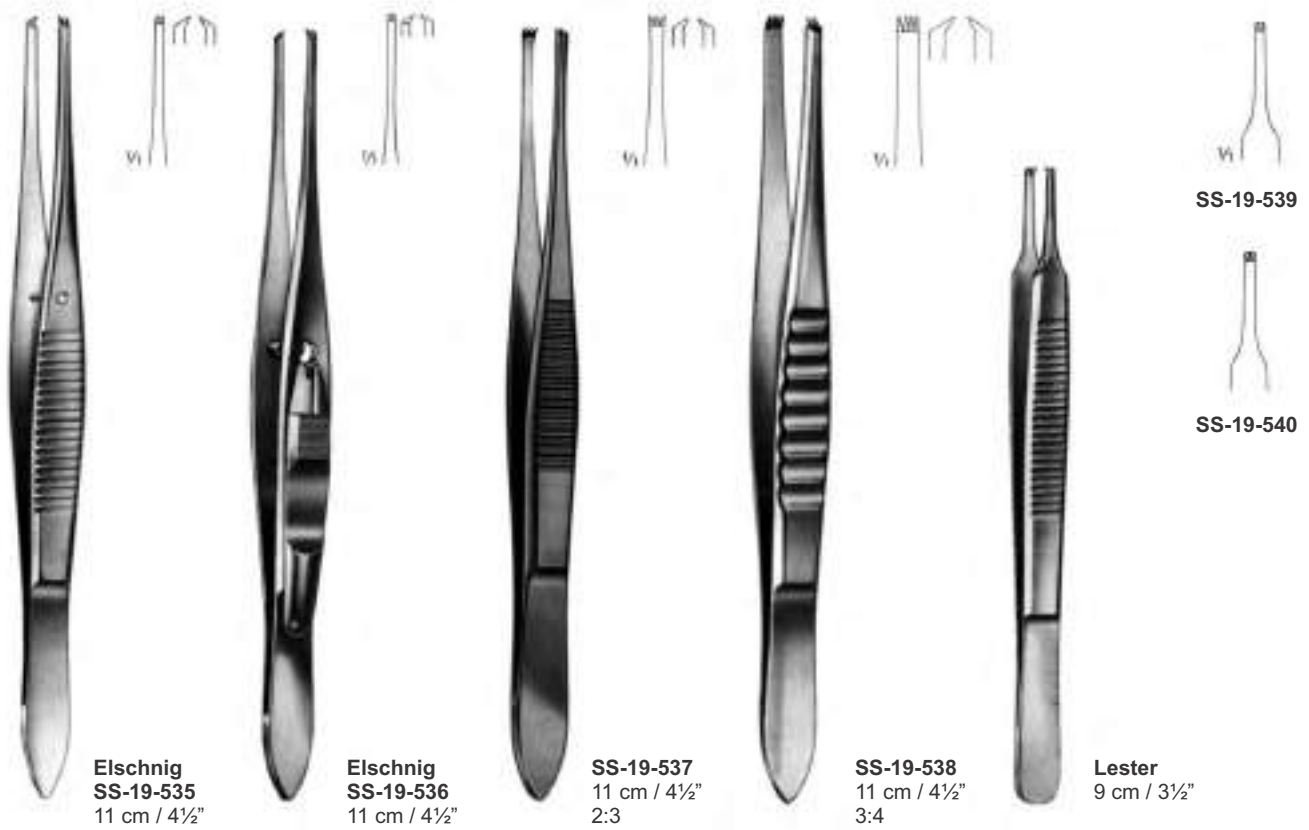
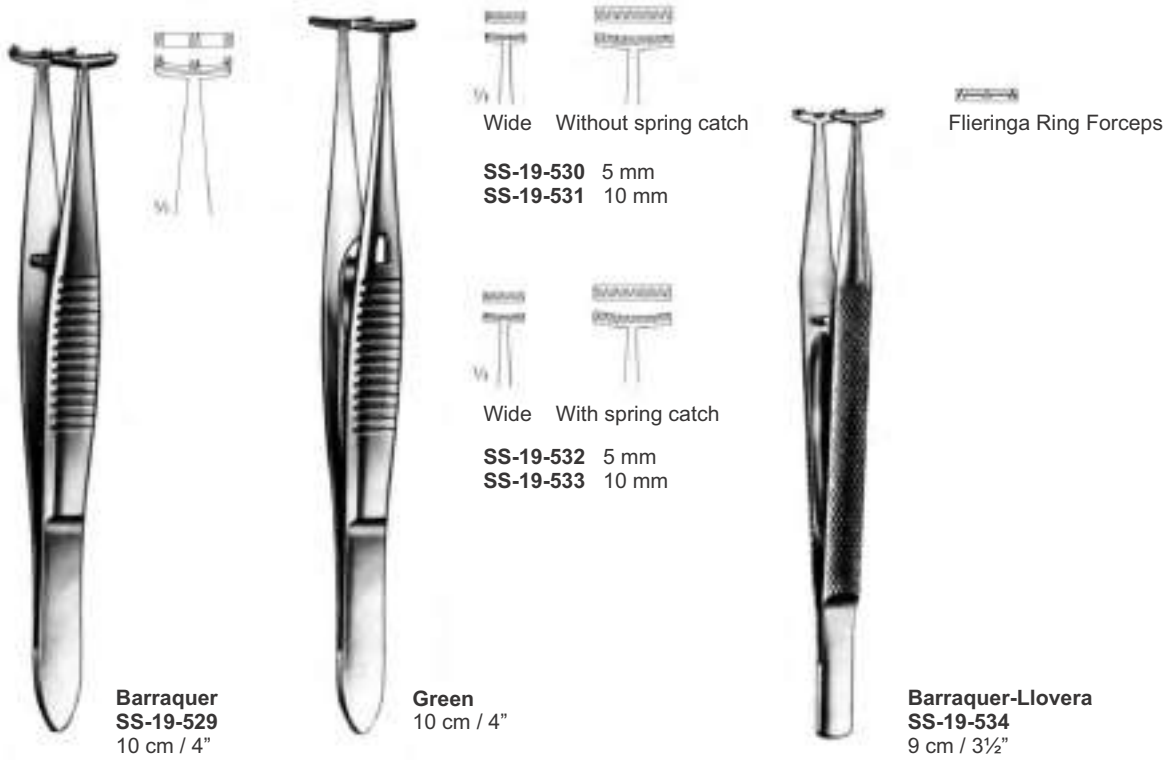

Suture Forceps, Antrior Chamber Forceps
 Pinzas para suture, Pinzas para la camara anterior
 Pincas a sutures, Pincas pour chamber anteriure



Moorfield
SS-19-541
 10 cm / 4"

Straight



Castroviejo
 10 cm / 4"

Curved



Castroviejo
 10 cm / 4"



St. Martin
SS-19-550
 7 cm / 2¾"

Width of teeth

- SS-19-542** 0.12 mm
- SS-19-543** 0.3 mm
- SS-19-544** 0.5 mm
- SS-19-545** 1.5 mm
- SS-19-546** 1.0 mm

Width of teeth

- SS-19-547** 0.5 mm
- SS-19-548** 1.5 mm
- SS-19-549** 1.0 mm

0.8 mm

Muscular Forceps



Troutman Rectus
SS-19-551
 8.5 cm / 3½"



Anterior Chamber Forceps



Barraquer
SS-19-552
 5.5 cm / 2¼"



Barraquer
SS-19-553
 5.5 cm / 2¼"



Barraquer
SS-19-554
 5.5 cm / 2¼"

Suture Forceps, Strabismus Forceps
Pinzas para sutura, Pinzas para estrabismo
Pincas a sutures, Pincas a strabisme



Bonaccolto
SS-19-555
10 cm / 4"



Bonaccolto
SS-19-556
10 cm / 4"



Nugent
10 cm / 4"



SS-19-557



SS-19-558



Bonaccolto
SS-19-559
11 cm / 4½"



Dastoor
SS-19-560
10 cm / 4"



Dastoor
SS-19-561
11 cm / 4½"



Dastoor
SS-19-562
11 cm / 4½"



Dastoor
SS-19-563
11 cm / 4½"



SAPTESTAR
Manufacturer & Exporter Of Surgical, Dental & Veterinary Instruments

Strabismus Forceps
Pinzas para estrabismo
Pinces a strabisme



McCullough
SS-19-564
9.5 cm / 3¾"



McCullough
SS-19-565
9.5 cm / 3¾"



Jameson
SS-19-566
10 cm / 4"

Jameson
SS-19-567
10 cm / 4"



Prince
SS-19-568
10 cm / 4"

Prince
SS-19-569
10 cm / 4"



Sattler
SS-19-570
10 cm / 4"

Sattler
SS-19-571
10 cm / 4"

Muscular Forceps

Advancement Forceps
Pinzas para estrabismo
Pincas a Strabisme



Blascovics
9 cm / 3½"

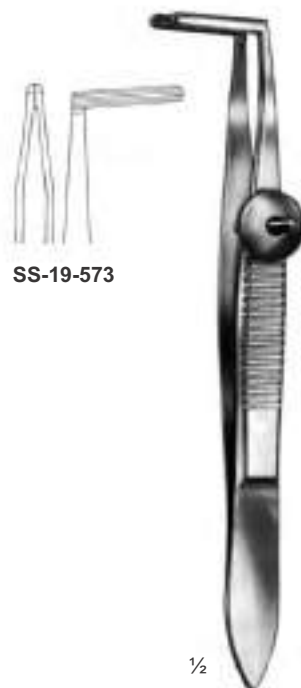

Blascovics
9 cm / 3½"

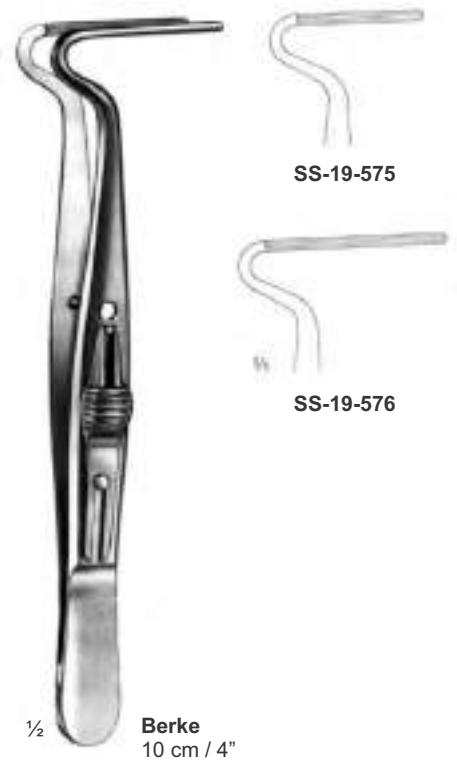

Berke
10 cm / 4"



Fink-Jameson
SS-19-577
10 cm / 4"



Berens
SS-19-578
10 cm / 4"



Bangerter
SS-19-579
10 cm / 4"



SAPTESTAR
Manufacturer & Exporter Of Surgical, Dental & Veterinary Instruments

Chalazion Forceps, Entropium Forceps
Pinzas de Chalazion, pinzas de entropion
Pincas a chalazion, pincas a entropion



Lordan
SS-19-580
9 cm / 3 1/2"



Cauer
SS-19-581
10 cm / 4"

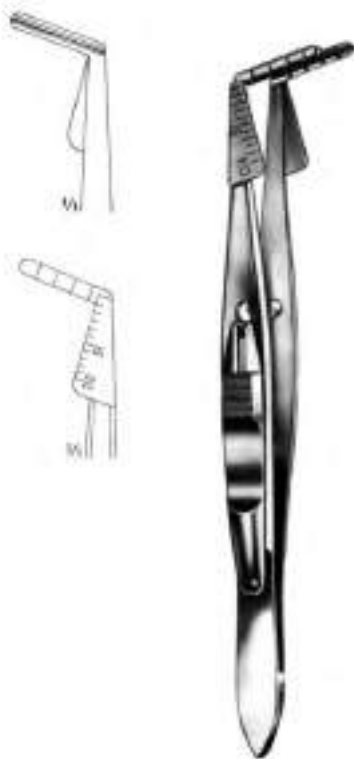

Berens
SS-19-582
10 cm / 4"



Snellen
SS-19-583
10 cm / 4"

Snellen
SS-19-584
10 cm / 4"

Suture Forceps
 Pinzas para sutura
 Pincers pour suture



Mod. Tübingen
SS-19-585
 10 cm / 4"



Paufigue
SS-19-586
 8.5 cm / 3 1/2"



Paufigue
SS-19-587
 8.5 cm / 3 1/2"



Barraquer mod.
SS-19-588
 10.5 cm / 4"



McPherson
SS-19-589
 10 cm / 4"



McPherson
SS-19-590
 10 cm / 4"

Skeleton Forceps, Fixation Forceps
Pinzas de esqueleto, pinzas de fijacion
Pincas a skelenton, pincas a fixer



Dermot Pierse
SS-19-591
8 cm / 3 1/4"



Dermot Pierse
SS-19-592
8 cm / 3 1/4"



Dermot Pierse
SS-19-593
8 cm / 3 1/4"



Dermot Pierse
SS-19-594
8 cm / 3 1/4"



Dermot Pierse
SS-19-595
8 cm / 3 1/4"



Dermot Pierse (Colibri)
SS-19-596
8 cm / 3 1/4"



Dermot Pierse (Colibri)
SS-19-597
8 cm / 3 1/4"



Dermot Pierse (Colibri)
SS-19-598
8 cm / 3 1/4"

Suture Forceps, Corneal Scissors
Pinzas para sutura, tijeras para de cornea
Pinces pour suture, ciseaux pour de la cornee



Kelman-McPherson
SS-19-599
10 cm / 4"



Barraquer
SS-19-600
7 cm / 2 3/4"
Suture Removal Forceps



Castroviejo
SS-19-601
10 cm / 4"
left



Castroviejo
SS-19-602
10 cm / 4"
right



Troutman-Castroviejo
SS-19-603
10 cm / 4"
left



Troutman-Castroviejo
SS-19-604
10 cm / 4"
right

Scissors
Tijeras
Ciseaux



Troutman-Castroviejo
SS-19-605
10 cm / 4"
right



Troutman-Castroviejo
SS-19-606
10 cm / 4"
left



Troutman
SS-19-607
10 cm / 4"
right



Troutman
SS-19-608
10 cm / 4"
left



Troutman-Castroviejo
SS-19-609
10 cm / 4"



Katzin
SS-19-610
10 cm / 4"
left



Katzin
SS-19-611
10 cm / 4"
right



Katzin
SS-19-612
11 cm / 4½"
left



Katzin
SS-19-613
11 cm / 4½"
right

Scissors
Tijeras
Ciseaux



Katzin-Barraquer
SS-19-614
10 cm / 4"
right



Katzin-Barraquer
SS-19-615
10 cm / 4"
left



SS-19-616
10 cm / 4"



SS-19-617
10 cm / 4"



Troutman-Castroviejo
SS-19-618
10.5 cm / 4"
right



Troutman-Castroviejo
SS-19-619
10.5 cm / 4"
left



Castroviejo
SS-19-620
10 cm / 4"



Castroviejo
SS-19-621
10 cm / 4"



Aebli
SS-19-622
10 cm / 4"



SAPTESTAR
Manufacturer & Exporter Of Surgical, Dental & Veterinary Instruments

Scissors
Tijeras
Ciseaux



Ong
SS-19-623
10 cm / 4"



SS-19-624

Wecker
11 cm / 4½"



SS-19-625



SS-19-626



Wecker, Mod. Martin
SS-19-627
11 cm / 4½"

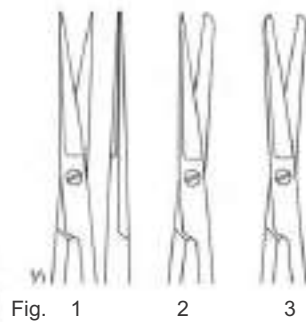

Noyes
SS-19-628 Fig. 1
SS-19-629 Fig. 2
SS-19-630 Fig. 3
12 cm / 4¾"

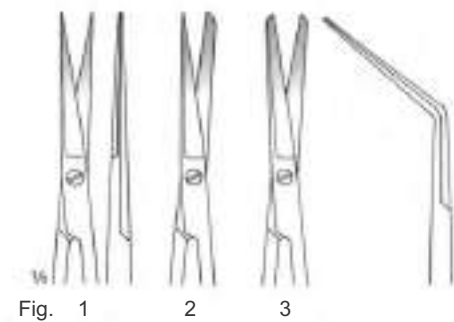

Noyes
SS-19-631 Fig. 1
SS-19-632 Fig. 2
SS-19-633 Fig. 3
12 cm / 4¾"

Scissors
Tijeras
Ciseaux



Gill-Welsch
SS-19-634
8 cm / 3¼"



Gill-Welsch
SS-19-635
8 cm / 3¼"



Gill-Welsch
SS-19-636
8.5 cm / 3½"



Gill-Welsch
SS-19-637
8.5 cm / 3½"



Vannas
SS-19-638
8 cm / 3¼"



Vannas
SS-19-639
8 cm / 3¼"



SS-19-640
8.5 cm / 3½"



Vannas Mod. Tübingen
SS-19-641
8.5 cm / 3½"



SS-19-642
8.5 cm / 3½"

Scissors
Tijeras
Ciseaux



Barraquer
5.5 cm / 2¼"



SS-19-643



SS-19-644



SS-19-645



Castroviejo
SS-19-646
10 cm / 4"

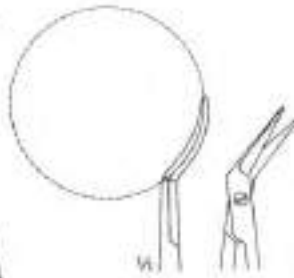

Castroviejo
SS-19-647
10 cm / 4"

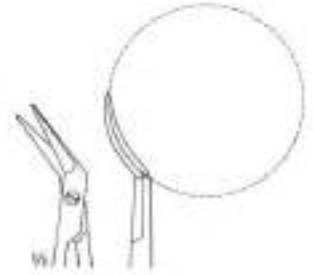

Castroviejo
SS-19-648
11 cm / 4 1/4"



Castroviejo
SS-19-649
11 cm / 4 1/4"



Castroviejo
SS-19-650
11 cm / 4 1/4"





14.5 cm / 5½"



**Dissection
 SS-19-651**

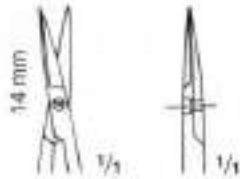

**Adventitia
 SS-19-654**



18 cm / 7"

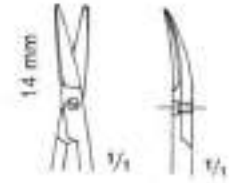

**Dissection
 SS-19-653**

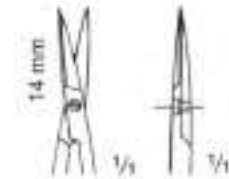

**Dissection
 SS-19-654**

Micro Scissors
Micro Tijeras
Micro Ciseaux



SS-19-655
14.5 cm / 5½"



SS-19-656
18 cm / 7"



SS-19-657
18 cm / 7"



11 cm / 4½"

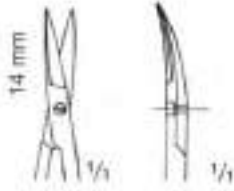

Dissection
SS-19-658

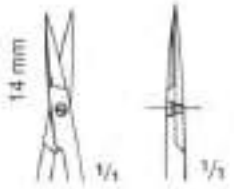

Adventitia
SS-19-659



15 cm / 6"

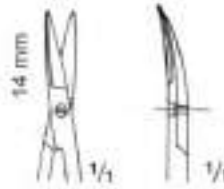

Dissection
SS-19-660

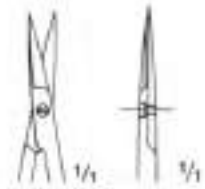

Adventitia
SS-19-661

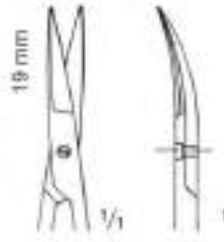

Dissection
SS-19-662

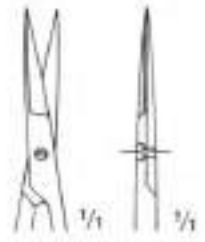

Adventitia
SS-19-663

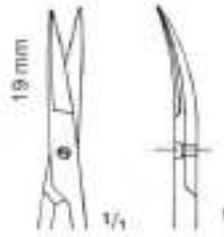

Dissection
SS-19-664

Nerve

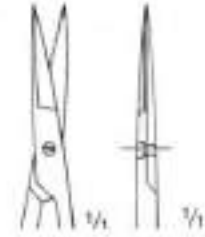

Adventitia
SS-19-665

Micro Scissors
 Micro Tijeras
 Micro Ciseaux



18.5 cm / 7¼"



SS-19-666



SS-19-667



SS-19-668
 SS-19-669
 SS-19-670



SS-19-671 16 cm / 6¼"
 SS-19-672 20 cm / 8"
 SS-19-673 22.5 cm / 9"



SS-19-674 SS-19-677
 SS-19-675 SS-19-678
 SS-19-676 SS-19-679



SS-19-680 SS-19-683 16 cm / 6¼"
 SS-19-681 SS-19-684 20 cm / 8"
 SS-19-682 SS-19-685 22.5 cm / 9"

Micro Scissors
 Micro Tijeras
 Micro Ciseaux



18 cm / 7"



SS-19-686
25°



SS-19-687
45°



SS-19-688
60°



SS-19-689
90°



SS-19-690
125°



18 cm / 7"



SS-19-691
25°



SS-19-692
45°



SS-19-693
60°



SS-19-694
90°



SS-19-695
125°



SAPTESTAR
Manufacturer & Exporter Of Surgical, Dental & Veterinary Instruments

Chalazion Forceps
Pinzas de chalazion
Pincas a chalazion

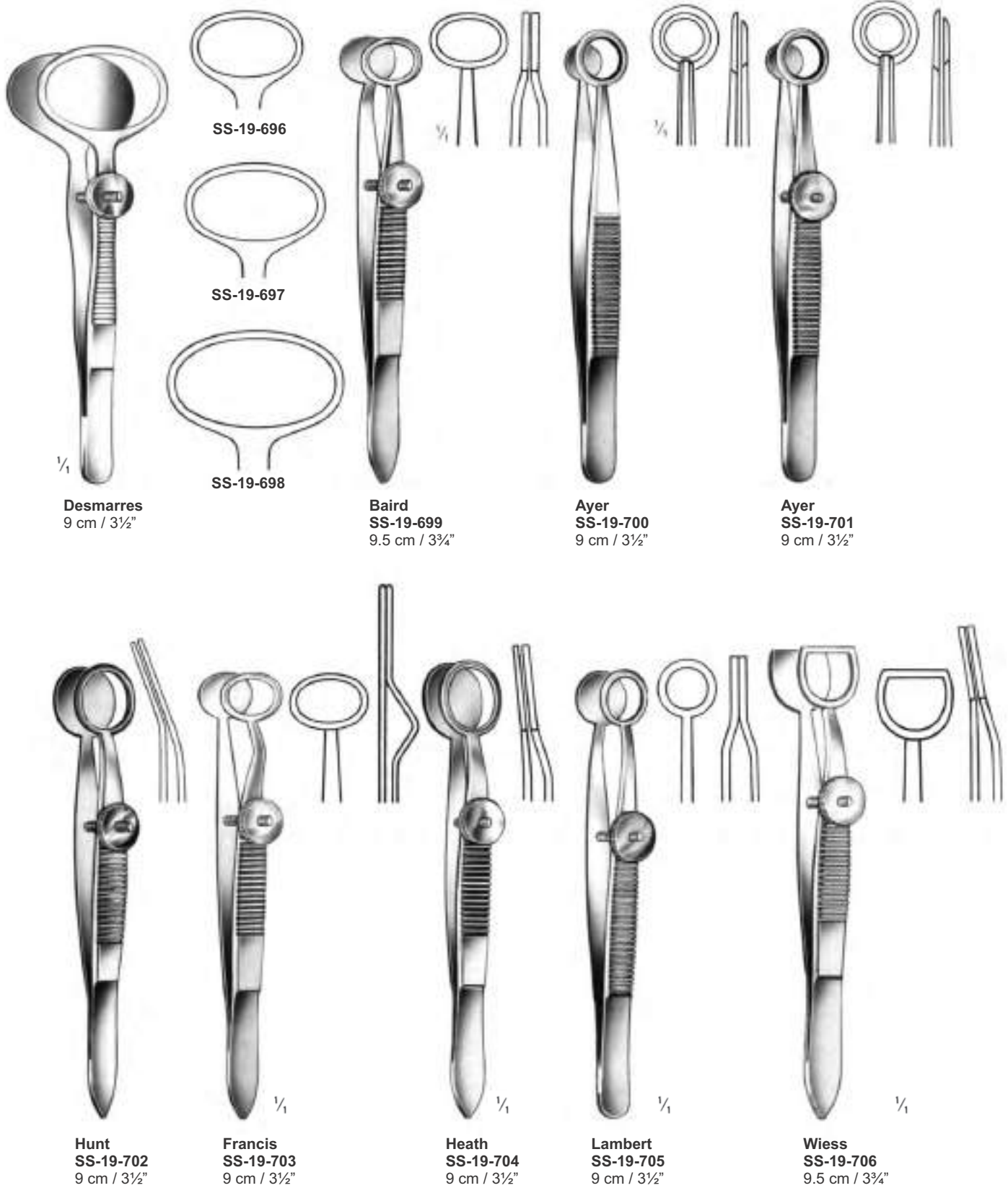

Desmarres
9 cm / 3½"

SS-19-696

SS-19-697

SS-19-698

Baird
SS-19-699
9.5 cm / 3¾"

Ayer
SS-19-700
9 cm / 3½"

Ayer
SS-19-701
9 cm / 3½"

Hunt
SS-19-702
9 cm / 3½"

Francis
SS-19-703
9 cm / 3½"

Heath
SS-19-704
9 cm / 3½"

Lambert
SS-19-705
9 cm / 3½"

Wiess
SS-19-706
9.5 cm / 3¾"

Fixation & Grasping Forceps
Pinzas de fijacion y de aprehension
Pincas a fixer at a saisir

Fixation and Grasping Forceps



Castroviejo
SS-19-707
9 cm / 3½"



Castroviejo
SS-19-708
9 cm / 3½"



Castroviejo
SS-19-709
9 cm / 3½"



Castroviejo
SS-19-710
9 cm / 3½"



Eischnig
SS-19-711
11 cm / 4½"

Other pattern on request



1 x 2 teeth

Lester
SS-19-712
9.5 cm / 3¾"



2 x 3 teeth

Lester
SS-19-713
9.5 cm / 3¾"



Fixation Forceps, without
spring catch

Barraquer
SS-19-714
10 cm / 4"



Flieringa Ring Forceps

Barraquer-Llovera
SS-19-715
9 cm / 3½"

Ligature Needles
 Agujas para ligaduras
 Aiguilles a ligatures

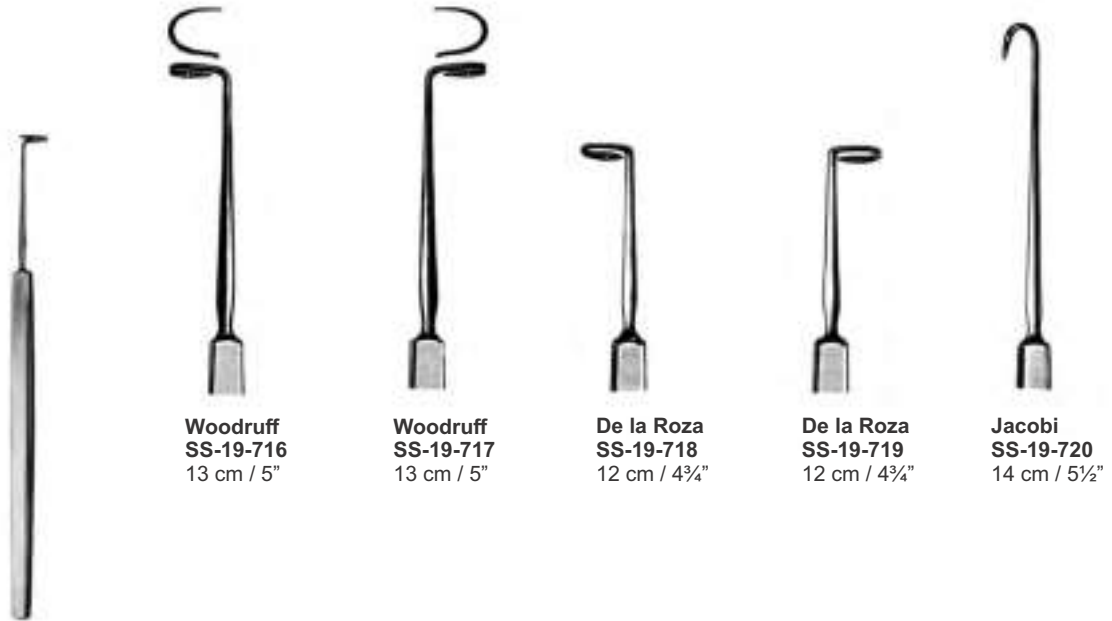

Woodruff
SS-19-716
 13 cm / 5"

Woodruff
SS-19-717
 13 cm / 5"

De la Roza
SS-19-718
 12 cm / 4¾"

De la Roza
SS-19-719
 12 cm / 4¾"

Jacobi
SS-19-720
 14 cm / 5½"

Instruments for Radial Keratotomy



- SS-19-721** 3.0 x 3.5 mm
- SS-19-722** 3.0 x 4.0 mm
- SS-19-723** 3.0 x 4.5 mm
- SS-19-724** 3.5 x 4.0 mm
- SS-19-725** 3.5 x 4.5 mm
- SS-19-726** 3.5 x 5.0 mm

Bores



- BC-19-727** 2.75 mm
- BC-19-728** 3.0 mm
- BC-19-729** 3.25 mm
- BC-19-730** 3.75 mm
- BC-19-731** 4.0 mm
- BC-19-732** 4.25 mm
- BC-19-733** 4.5 mm
- BC-19-734** 4.75 mm
- BC-19-735** 5.0 mm
- BC-19-736** 6.0 mm
- BC-19-737** 8.0 mm

Bores

Instruments for Radial keratotomy

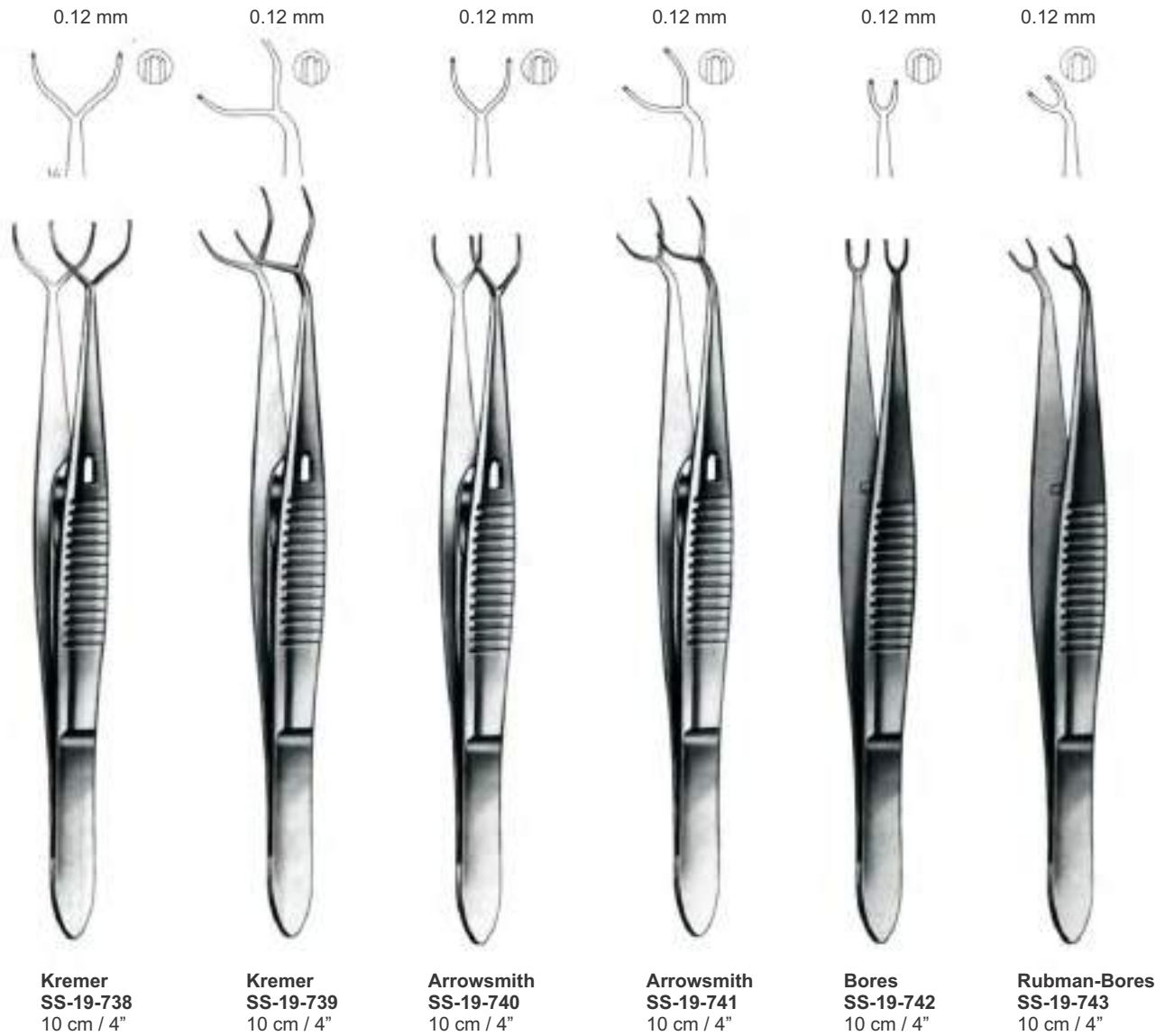

Corneal Fixation Forceps, Straight, 13 mm
 Corneal Fixation Forceps, Curved, 13 mm
 Corneal Fixation Forceps, Straight, 8 mm
 Corneal Fixation Forceps, Curved, 8 mm
 Corneal Fixation Forceps, Straight, 3 mm
 Corneal Fixation Forceps, Curved, 3 mm

Instruments for Radial Keratotomy



Arrowsmith
SS-19-744
10 cm / 4"



Bores
SS-1-745
10 cm / 4"



Bores
SS-1-746
10 cm / 4"



Bores
SS-1-747
10 cm / 4"



Thornton
SS-1-748
10 cm / 4"

Corneal Marker, 8 blades
Corneal Marker, 6 blades
Corneal Marker, 8 blades
Fixation Ring, 15 mm
Fixation Ring, 16 mm

Instruments for Radial Keratotomy



Hoffer

- SS-19-749 3.0 mm
- SS-19-750 3.25 mm
- SS-19-751 3.50 mm
- SS-19-752 3.75 mm
- SS-19-753 4.0 mm
- SS-19-754 4.25 mm
- SS-19-755 4.5 mm
- SS-19-756 4.75 mm
- SS-19-757 5.0 mm
- SS-19-758 5.5 mm
- SS-19-759 6.0 mm
- SS-19-760 7.0 mm
- SS-19-761 8.0 mm
- SS-19-762 9.0 mm
- SS-19-763 11 mm



3--5 mm



Hoffer
SS-19-764



SS-19-765
3--5--7 mm



SS-19-766
3--6--8 mm



Hoffer

Optical Zone Marker, with cross hairs
Double Marker with two rings, 3--5 mm
Triple Marker with three rings, 3--5--7 mm
Triple Marker with three rings, 3--6--8 mm

Instruments for Radial Keratotomy



Bores
SS-19-767
10 cm / 4"



SS-19-768



SS-19-769
0.55 mm



SS-19-770
0.6 mm

Incision Spreading Forceps
Incision Forceps
Depth Gauge, 0.55 mm
Depth Gauge, 0.60 mm

Eye Scalpels, Cataract Knives
Bisturios para ojos, cuchillos para cataratas
Bistouris pour les yeux, couteaux a cataracte

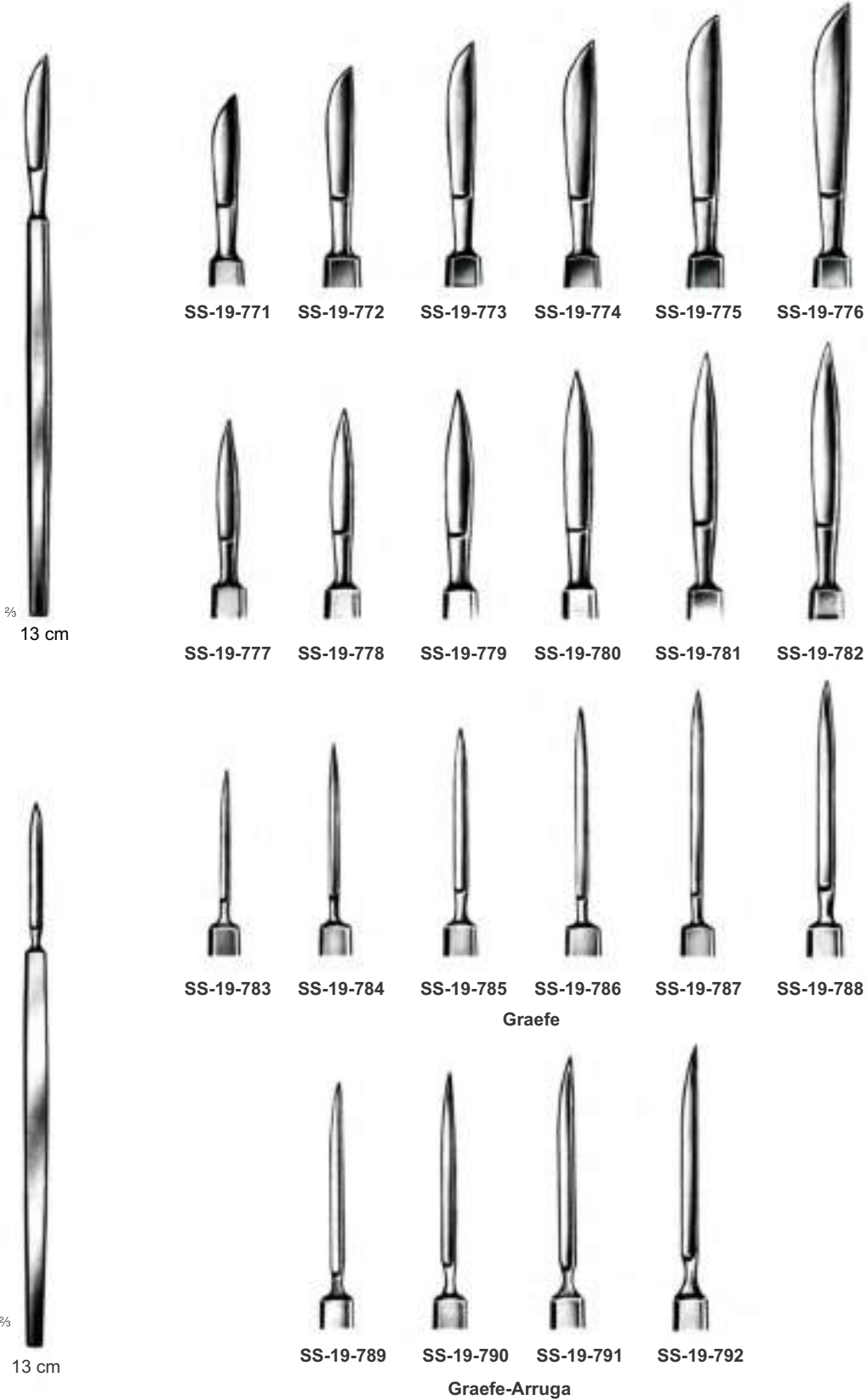



SAPTESTAR
Manufacturer & Exporter Of Surgical, Dental & Veterinary Instruments

Cataract, Glaucoma & Discission Knives
Cuchillos para cataratas, glaucoma y discisiones
Couteaux a cataracte, a glaucome et a discisions



Graefe
SS-19-793



Deuschmann
SS-19-794



Schmith-Green
SS-19-795 SS-19-796



Berens
SS-19-797A

Right curved
curvo derecha
courbe a droite

Left curved
curvo izquierda
courbe a gauche



Wheeler
SS-19-798
18 x 1 mm

Keratomes
Cuchillos lanceolares (Querátomos)

Couteaux lancéolaires (Keratomes)



Jaeger
13 cm



SS-19-799



SS-19-800



SS-19-801



SS-19-802



SS-19-803



SS-19-804



SS-19-805



SS-19-806



SS-19-807



SS-19-808



SS-19-809

Keratomes
Cuchillos lanceolares (Quer tomos)
Couteaux lancéolaires (Kératomes)



SS-19-810 SS-19-811 SS-19-812 SS-19-813

Jaeger-Grieshaber



SS-19-814 SS-19-815 SS-19-816 SS-19-817

Jaeger-Grieshaber



SS-19-818 4 mm SS-19-819 5 mm SS-19-820 6 mm SS-19-821 7 mm

Wessely-Grieshaber
curvature - curvatura - courbure 45°



Wiener
SS-19-822



Berens
SS-19-823



Berens
SS-19-824



Papst
SS-19-825



Castroviejo
SS-19-826
4 x 13 mm



Wecker
SS-19-827



Wecker
SS-19-828



Wecker
SS-19-829



Wecker
SS-19-830

Various Eye Knives
 Varios Cuchillos para ojo
 Divers couteaux oculaires



Rowland
 SS-19-831



Mod. Tübingen
 SS-19-832



Graefe
 SS-19-833



Schnaudigl
 SS-19-834



Weber
 SS-19-835



Weber
 SS-19-836



Weber
 SS-19-837



Mod. Hamburg



Bowman
 SS-19-838
 0.4 mm



Bowman
 SS-19-839
 0.5 mm



Bowman
 SS-19-840
 0.6 mm



Bowman
 SS-19-841
 0.7 mm



Bowman
 SS-19-842
 0.8 mm



Bowman
 SS-19-843
 0.9 mm



Bowman
 SS-19-844
 1.0 mm



Bowman
 SS-19-845
 left
 derecha
 á gauche



Bowman
 SS-19-846
 right
 á droite



Bowman
 SS-19-847



Knapp
 SS-19-848



Knapp
 SS-19-849



Knapp
 SS-19-850

Various Eye Knives
 Varios Cuchillos para ojo
 Divers couteaux oculaires



Ziegler
 SS-19-851
 5 mm



Ziegler
 SS-19-852
 6 mm



Ziegler
 SS-19-853
 7 mm



Kuhnt
 SS-19-854



Kuhnt
 SS-19-855



Ziegler
 SS-19-856
 3 ½ mm



Sato
 SS-19-857



Dean
 13 cm



Sichel
 SS-19-858



SS-19-859



Johnson
 SS-19-860



Haab
 SS-19-861



Graefe
 SS-19-862



SS-19-863



Graefe
 SS-19-864



Kuhnt
 SS-19-865



Kuhnt
 SS-19-866



Kuhnt
 SS-19-867



Kuhnt
 SS-19-868



SAPTESTAR
Manufacturer & Exporter Of Surgical, Dental & Veterinary Instruments

Various Eye Knives
Varios Cuchillos para ojo
Divers couteaux oculaires



Elschnig
SS-19-869



Johnson-Took
SS-19-870



Took
SS-19-871



Desmarres
SS-19-872



Desmarres
SS-19-873



Desmarres
SS-19-874



Gill
SS-19-875



Graefe
SS-19-876



Paton
13 cm



Wecker
SS-19-877



Axenfeld
SS-19-878



Axenfeld
SS-19-879

Sclerotomes, Pterygium, Blepharoptosis Knives
 Esclerotomos, cuchillos para terigion y blefaroptosis
 Sclerotomes, couteaux pour pterygium, couteau pour ptosis



Walker-Lee
 SS-19-880



Guthrie
 SS-19-881



Elschnig
 SS-19-882



McReynolds
 SS-19-883



Anderson-Critchett
 SS-19-884



Lundsgaard
 SS-19-885



Guyton-lundsgaard
 SS-19-886



Curdy
 SS-19-887



Barraquer
 SS-19-888



Johnson
 SS-19-889



Barkan
 SS-19-890



Scheie
 SS-19-891



Searcy
 SS-19-892



Burch
 SS-19-893



SS-19-894



SS-19-895



SS-19-896



SS-19-897



Daily
 SS-19-898



Desmarres
 SS-19-899



Desmarres
 SS-19-900

Discission Needles, Foreign Body Instruments
Agujas para discision, instrumentos para cuerpos extraños
Aiguilles a discion, instruments a corps etrangers



Bowman
SS-19-901



Bowman
SS-19-902



Schweigger
SS-19-903



Schweiz-Mod.
SS-19-904



SS-19-905



SS-19-906



Levinson
SS-19-907



Alvis
SS-19-908



Francis
SS-19-909



La Force
(Golf-Club)
SS-19-910



Dix
SS-19-911



Ellis
SS-19-912



Plange
SS-19-913



Nicati
SS-19-914



Walton
SS-19-915

Round-Handled Forceps

Round, Hollow Handle Forceps

SS-19-916

Length: 14 cm / 5½"

Tips: straight 0.15 mm



Round, Hollow Handle Forceps

SS-19-917

Length: 14 cm / 5½"

Tips: straight 0.15 mm tips
with tying platform



Round, Hollow Handle Forceps

SS-19-918

Length: 14 cm / 5½"

Tips: straight 0.3 mm tips
with tying platform



Round, Hollow Handle Forceps

SS-19-919

Length: 15 cm / 6"

Tips: 0.15 mm tips
bent at 45°



Round, Hollow Handle Forceps

SS-19-920

Length: 15 cm / 6"

Tips: straight 0.15 mm



Round, Hollow Handle Forceps

SS-19-921

Length: 15 cm / 6"

Tips: curved 0.3 mm



Dilator Forceps

SS-19-922

Length: 14 cm / 5½"

Tips: straight 0.15 mm tips



Forceps & Scissors

Microintraocular forceps

SS-19-923

Length: 14 cm / 5½"

Jaws: 2.5 x 0.3 x 0.25 mm (lwxwt), 1.5 mm maximum opening



SS-19-924

Length: 14 cm / 5½"

Jaws: 3 x 0.6 x 0.4 mm (lwxwt), 1.4 mm maximum opening



Tip Profile:

Scissors

SS-19-925

14 cm / 5½"

Round hollow handles
curved blades



Tip Profile:

Scissors

SS-19-926

14 cm / 5½"

Round hollow handles
straight blades



Microintraocular scissors

SS-19-927

14 cm / 5½"

30° angled blades



Tip Profile:

Microintraocular Scissors

SS-19-928

14 cm / 5½"

35° angled blades



Tip Profile:

Needle Holder

SS-19-929

12.5 cm / 5" Long
 round handle
 0.4 mm tips
 curved smooth jaws



Stevens Needle Holder

SS-19-930

13 cm / 5" Long
 Straight 1 mm wide serrated tips



Needle Holder

SS-19-931

14 cm / 5½" Long
 round hollow handle
 Straight smooth jaws



Needle Holder

SS-19-932

14 cm / 5½" Long
 round hollow handle
 curved smooth jaws



Razor Blade Holder

SS-19-933

12.5 cm / 5" Long
 round tips
 S-Shaped jaw



Special jaw shape prevents blades from slipping

Razor Blade Holder

SS-19-934

12 cm / 4¾" Long
 round tips
 convex/concave jaws



Titanium Scissors

SS-19-936

Castroviejo corneal scissors, 12 cm long curved, blunt tips, small and thin blades cuts 6/0 traction suture, round handles



SS-19-937

Vannas scissors, 11 cm / 4.3" Long, straight, 13 mm blades, sharp points.



SS-19-938

Vannas scissors, 10.5 cm / 4" Long, angled, sharp tips, 10.5 mm blades



SS-19-939

McPherson-Westcott stitch scissors, 11.5 cm / 4½" Long, very sharp pointed tips, small blades, flat handle.



SS-19-940

Westcott stitch scissors, 11cm / 4.3" Long, very sharp pointed tips, standard blades, flat handle.



SS-19-941

McPherson-Westcott scissors, 11 cm / 4.3" Long, curved blunt tips, small blades, and cutting 4-0 suture, flat handles.



SS-19-942

Westcott tenotomy scissors, 11.5 cm / 4½" Long, curved blunt tips, standard blades, flat right handles.



SS-19-943

Conjunctival scissors, 12 cm / 4¾" Long, round handle, curved, blunt tips, small blades



Titanium Scissors

SS-19-944

Iris scissors, 10.5 cm / 4" Long, curved



1/3

SS-19-945

Vannas scissors, 11 cm / 4.3" Long, straight sharp tips, 10.5 mm blades



1/3

SS-19-946

Castroviejo scissors, 11 cm / 4.3" Long, small blades, cuts 4/0 suture, angled left.



1/3

SS-19-947

Castroviejo scissors, 11 cm / 4.3" Long, small blades, cuts 4/0 suture, angled right



1/3

SS-19-948

Castroviejo scissors, 12 cm / 4 3/4" Long, strong curve, round handles,



1/3

SS-19-949

Castroviejo corneal scissors, 12 cm / 4 3/4" Long, curved, blunt tips, medium blades, cuts 4/0 suture, round handles,



1/3

SS-19-950

Vannas scissors, 10.5 cm / 4") Long, curved, sharp tips, 12.5 mm blades.



1/3

SS-19-951

Vannas scissors, 10.5 cm / 4") Long, curved, sharp tips, 10.5 mm blades.

Titanium Needle Holders

SS-19-952

Needle holder, 12 cm / 4¾" Long,
curved, standard range, without lock.



SS-19-953

Needle holder, 12 cm / 4¾" Long,
curved, standard range, with lock.



SS-19-954

Barraquer Needle holder, 12 cm / 4¾" Long,
curved, without lock.



SS-19-955

Barraquer Needle holder, 12 cm / 4¾" Long,
curved, with lock.



SS-19-956

Troutman Needle holder, 12 cm / 4¾" Long,
10 mm light curved jaws, without lock.



SS-19-957

Troutman Needle holder, 12 cm / 4¾" Long,
10 mm light curved jaws, with lock.



SS-19-958

Blade Breaker, 12.5 cm / 5" Long,



Titanium Tying & notched Tip Forceps

SS-19-959

Tying forceps, standard range, 11.5 cm / 4½" Long, straight, 0.25 x 0.15 mm tips, with 4 mm long tying platform.



1/1

SS-19-960

Tying forceps, ultra fine range, 11.5 cm / 4½" Long, straight, 0.25 x 0.15 mm tips, with 4 mm long tying platform.



1/1

SS-19-961

McPherson Tying forceps, 11.5 cm / 4½" Long, 45° angled, 12 mm shafts, 0.25 x 0.15 mm tips, with 4 mm long tying platform.



1/1

SS-19-962

McPherson Tying forceps, 11.5 cm / 4½" Long, 45° angled, 12 mm shafts, 0.25 x 0.15 mm tips, with 4 mm long tying platform.



1/1

SS-19-963

Notched forceps, 8.5 cm / 3¼" Long, straight, 1 x 1 teeth, with tying platform, standard range.

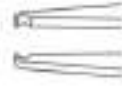

1/1

SS-19-964

Notched forceps, 11.5 cm / 4½" Long, 1 x 1 teeth, with tying platform, standard range, straight.



1/1

SS-19-965

Notched forceps, 11.5 cm / 4½" Long, 1 x 1 teeth, with tying platform, ultra fine range, straight.



1/1

SS-19-966

Pierce-Colibri corneal forceps, 7.5 cm / 3" Long fine, 1 x 1 pierse teeth, with tying platform.



1/1

Titanium Tooth Forceps

SS-19-967

Colibri suturing fine forceps, 7.5 cm / 3" Long, 140° toothed (1x2 teeth), 0.1 mm, with tying platform.



1/1

SS-19-968

Suturing forceps, ultra fine range, 8.5 cm / 3¼" Long, straight, 140° toothed (1x2 teeth), 0.12 mm with tying platform.



1/1

SS-19-969

Colibri Suturing forceps, 8.5 cm / 3¼" Long, 140° very delicate toothed (1x2 teeth), 0.10 mm, with tying platform.



1/1

SS-19-970

Suturing forceps, ultra fine range, 11.5 cm / 4½" Long, Straight, 140° toothed (1x2 teeth), 0.12 mm, with tying platform.



1/1

SS-19-971

McPherson 90° toothed forceps, 8.5 cm / 3¼" Long, 45° angled, 12 mm straight shafts, 1x2 teeth, 0.10 mm, with tying platform.



1/1

SS-19-972

Colibri forceps, 8.5 cm / 3¼" Long, 90° toothed, (1x2 teeth), 0.12 mm, with tying platform.



1/1

SS-19-973

90° toothed forceps, 11.5 cm / 4½" Long, 0.12mm, 1 x 2 teeth, straight, with tying platform.



1/1

SS-19-974

90° toothed forceps, 11.5 cm / 4½" Long, 1x2 teeth, straight, 0.10 mm, with tying platform.



1/1

SS-19-975

Colibri 90° toothed forceps, 11.5 cm / 4½" Long, 1x2 teeth, 0.10 mm, with tying platform.



1/1

Titanium Special Use Forceps

SS-19-976

Kelman- McPherson forceps, 8.5 cm / 3¼" Long, 45° angled, very delicate, 7.5 mm long smooth platform



1/1

SS-19-977

Kelman-McPherson forceps, 11.5 cm / 4½" Long, 45° angled, very delicate, 7.5 mm long smooth platform



1/1

SS-19-978

Claymans type 10L forceps, 10.5 cm / 4" Long,



1/1

SS-19-979

10L forceps, with thin ring tips, 10.5 cm / 4" Long,



1/1

SS-19-980

Jaffe-Blaydes 10L forceps, 10.5 cm / 4" Long,



1/1

SS-19-981

Kelman-McPherson Style lens holding forceps, 11.5 cm / 4½" Long, round smooth jaws for holding soft 10Ls.



1/1

SS-19-982

Lens implantation forceps for holding soft 10Ls, 11.5 cm / 4½" Long, The jaw s' smooth surfaces and rounded edges grip the lens firmly and gently.



1/1

SS-19-983

Direct action Lens implantation forceps for holding soft acrylic 10Ls, 12 cm / 4¾" Long, curved jaws, without lock, round handles.



1/1

Titanium Special Use Forceps

SS-19-984

Direct action lens implantation forceps for holding soft acrylic 10Ls', 12 cm / 4¾" Long, curved jaws, with lock, round handle.



1/1

SS-19-985

Capsulorhexis forceps, 8.5 cm / 3¼" Long, Cystotome tips, extremely thin and straight shanks, flat handles.



1/1

SS-19-986

Capsulorhexis forceps, 8.5 cm / 3¼" Long, Cystotome tips, recessed inside jaw surfaces, extremely thin and vaulted shanks, flat handle.



1/1

SS-19-987

Capsulorhexis forceps, 11.5 cm / 4½" Long, Cystotome tips, recessed inside jaw surfaces, extremely thin and vaulted shanks, flat handle.



1/1

SS-19-988

Capsulorhexis forceps, 10.5 cm / 4" Long, recessed inside jaw surfaces, extremely thin and vaulted shanks with guide pin, round handle.



1/1

SS-19-989

Capsulorhexis forceps, 12 cm / 4¾" Long, 12 mm blades, gap between blades, Tongue and groove iris stop, extremely thin and straight shanks, round handle.



1/1

SS-19-990

Capsulorhexis forceps, 12 cm / 4¾" Long, 12 mm blades, gap between blades, Tongue and groove iris stop, vaulted and extremely thin and curved shanks, round handle.



1/1

SS-19-991

Capsulorhexis notched forceps, 8.5 cm / 3¼" Long, platform at tips, recessed inside jaw surfaces, extremely thin and vaulted shanks, flat handle.



1/1

SS-19-992

Capsulorhexis notched forceps, 11.5 cm 4½" Long, platform at tips, recessed inside jaw surfaces, extremely thin and vaulted shanks, flat handles.



1/1

Titanium Special Use Forceps, Retractors

SS-19-993

Hofmann-Polack corneal suturing forceps, 11.5 cm / 4½" Long, 45° angled, 1 mm spread, 1x1 pierse teeth, 0.25 mm



SS-19-994

Polack corneal suturing forceps, 11.5 cm / 4½" Long, 45° angled, 1 mm spread, very delicate, 1x2 teeth, 0.12 mm



1/1

SS-19-995

Lieberman LASIK solid speculum 7.5 cm / 3" Long, with 12.5 mm Long blades and maximum spread of 3 cm.



1/1

SS-19-996

Machat LASIK adjustable wire speculum 8 cm / 3" Long with 14.5 mm blades and maximum spread of 3.5 cm.



1/1

SS-19-997

Adjustable wire speculum 6.5 cm / 2½" Long, maximum spread of 2.2 cm.

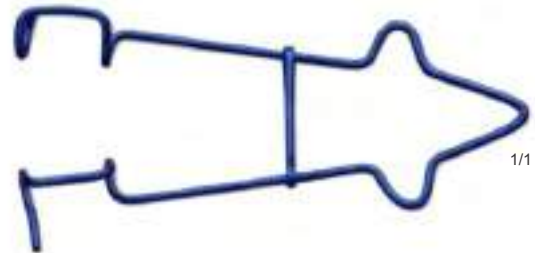

1/1

SS-19-998

Wire speculum 4.5 cm / 1¾" Long, with 13.5 mm blades and maximum spread of 20 cm.

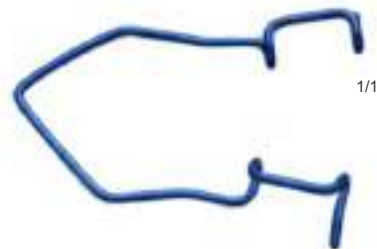

1/1

Hooks, Probes, Spatulas

SS-19-999

Lens nucleus rotator, 12 cm / 4¾" Long, V-shaped tips, angled



1/1

SS-19-1000

Gass muscle hook, 12.5 cm / 5" Long, with oval hole, 10 mm long.



1/1

SS-19-1001

Fenzl lens manipulator, 12 cm / 4¾" long, T-shaped tip, angled.



1/1

SS-19-1002

Button manipulator, 11.5 cm / 4 ½" Long



1/1

SS-19-1003

Haefliger phaco cleaver, 12 cm / 4¾" Long



1/1

SS-19-1004

Kansas nucleus vectis, 12.5 cm / 5" Long



1/1

SS-19-1005

Akahoshi nucleus sustainer,, 11.5 cm / 4½" Long



1/1

SS-19-1006

Phaco claw chopper,, 11 cm / 4.3" Long straight



1/1

SS-19-1007

Nichamin Phaco triple chopper, 12 cm / 4¾" Long, angled, rounded and highly polished distal tip, straight shank.



1/1

SS-19-1008

Minami "M" hook, 11.5 cm / 4½" Long



1/1

SS-19-1009

Corneal Epithelium Spatulae, 11 cm / 4.3" Long



1/1

Titanium Hooks, Probes, Spatulas

SS-19-1010

Lester 10L manipulator, 12 cm / 4¾" Long, vaulted shank, angled



SS-19-1011

Jaffe-Knolle Iris hook, 11.5 cm / 4½" Long, very blunt, small, angled.



SS-19-1012

Sinskey lens manipulating hook 12 cm / 4¾", Long, 0.15 mm dia blunt tip, Straight shank, angled to right.



SS-19-1013

Lewicky lens manipulating hook, 12 cm / 4¾" Long, 0.15 mm dia blunt tip, vaulted shank, angled to right.



SS-19-1014

Rentsch "Boat hook" lens manipulator, 11 cm / 4.3" Long,



SS-19-1015

Synechia spatula, 12 cm / 4¾" Long, smooth, 0.70 mm wide.



SS-19-1016

Kansas nucleus bisector, 11 cm / 4.3" Long, for manual small incision surgery.



SS-19-1017

Kansas nucleus trisector, 10 cm / 4" Long



SS-19-1018

Lens loop, 12 cm / 4¾" Long, 3 mm wide, serrated



SS-19-1019

Connor intracapsular manipulator, 12 cm / 4¾" Long, straight shank



SS-19-1020

Neuliann nucleus divider and manipulator, 11 cm / 4.3" Long





Anesthesia 20

20 Anesthesia

Magill	01
Miller	02
Miller	02
Miller-Baby	02
Miller Laryngoscopes	03
Guedel-Negus	04
Mcintosh	05
Mcintosh	05
Foregger	06
Foregger	07
Mcintosh	08
Mcintosh	08
Mcintosh	09
Foregger	10
Miller	11
Foregger	12
Miller	13
Fiber Optic Laryngoscopes	14

Catheter introducing Forceps
Pinzas para cateteres
Pincas pour introduire les sondes



SS-20-101
14.5 cm / 5 ¾"
for babies
para neonatales
pour nourrissons



SS-20-102
20 cm / 8"
for children
para niños
pour enfants



SS-20-103
25 cm / 10"
for adults
para adultos
pour adultes



Magill



**Miller
SS-20-104**
with three laryngoscope blades fig. 1 to 3
complete, in case

con tres hojas de laringoscopia fig. 1 a 3
completo, en estuche

avec trois spatules a laryngoscopie fig. 1 a 3
complet, en trousse

**Miller
SS-20-105**
with four laryngoscope blades fig. 1 to 4
complete, in case

con cuatro hojas de laringoscopia fig. 1 a 4
completo, en estuche

avec quatre spatules a laryngoscopie fig. 1 a 4
complet, en trousse

**Miller-Baby
SS-20-106**
with two laryngoscope blades fig. 0 and 1
complete, in case

con dos hojas de laringoscopia fig. 0 y 1
completo, en estuche

avec deux spatules a laryngoscopie fig. 0 a 1
complet, en trousse



SS-20-107
Fig. 0
for babies
para neonatales
pour nourrissons
per neonati

Working length
largo util
Longueur utile
lunghezza operante
55 mm



SS-20-108
Fig. 1
for children
para niños
pour enfants

Working length
largo util
Longueur utile
80 mm



SS-20-109
Fig. 2
for adolescents
para adolescentes
pour adolescents

Working length
largo util
Longueur utile
130 mm



SS-20-110
Fig. 3
for women
para mujeres
pour femmes

Working length
largo util
Longueur utile
170 mm



Miller

SS-20-111
Fig. 4
for men
para hombres
pour hommes

Working length
largo util
Longueur utile
180 mm



Guedel-Negus

SS-20-112

with three laryngoscope blades fig. 1 to 4 complete, in case

con tres hojas de laringoscopio fig. 2 a 4 completo, en estuche

avec trois spatules a laryngoscopie fig. 2 a 4 complet, en trousse



SS-20-113

Fig. 1
for children
para niños
pour enfants

Working length
largo útil
Longueur utile
70 mm



SS-20-114

Fig. 2
for adolescents
para adolescentes
pour adolescents

Working length
largo útil
Longueur utile
90 mm



SS-20-115

Fig. 3
for women
para mujeres
pour femmes

Working length
largo útil
Longueur utile
110 mm



SS-20-116

Fig. 4
for men
para hombres
pour hommes

Working length
largo útil
Longueur utile
135 mm



**McIntosh
 SS-20-117**

with three laryngoscope blades fig. 1 to 3 complete, in case

con tres hojas de laringoscopio fig. 1 a 3 completo, en estuche

avec trois spatules a laryngoscopie fig. 1 a 3 complet, en trousse



SS-20-119

Fig. 0
 for babies
 para neonatales
 pour nourrissons

Working length
 largo util
 Longueur utile
 55 mm



SS-20-120

Fig. 1
 for children
 para ninos
 pour enfants

Working length
 largo util
 Longueur utile
 75 mm



SS-20-121

Fig. 2
 for adolescents
 para adolescentes
 pour adolescents

Working length
 largo util
 Longueur utile
 90 mm

**McIntosh
 SS-20-118**

with four laryngoscope blades fig. 1 to 4 complete, in case

con cuatro hojas de laringoscopio fig. 1 a 4 completo, en estuche

avec quatre spatules a laryngoscopie fig. 1 a 4 complet, en trousse



SS-20-122

Fig. 3
 for women
 para mujeres
 pour femmes

Working length
 largo util
 Longueur utile
 110 mm



SS-20-123

Fig. 4
 for men
 para hombres
 pour hommes

Working length
 largo util
 Longueur utile
 135mm



**Foregger
SS-20-124**

with three laryngoscope blades fig. 2 to 4
complete, in case

con tres hojas de laringoscopio fig. 2 a 4
completo, en estuche

avec trois spatules a laryngoscopie fig. 2 a 4
complet, en trousse



SS-20-125
Fig. 1
for children
para niños
pour enfants

Working length
largo util
Longueur utile
70 mm



SS-20-126
Fig. 2
for adolescents
para adolescentes
pour adolescents

Working length
largo util
Longueur utile
90 mm



SS-20-127
Fig. 3
for women
para mujeres
pour femmes

Working length
largo util
Longueur utile
110 mm



SS-20-128
Fig. 4
for men
para hombres
pour hommes

Working length
largo util
Longueur utile
135mm



SS-20-134
 Batteries set of 2 pieces
 Pilas
 juego de 2 piezas
 Pilas jue avec deux pieces

SS-20-135
 Battery Handle
 (without batteries), for laryngoscopes set
 Mango de pilas (sin pilas), para juegos de laringoscopio
 Manche a pile (sans pile), pour jeux a laryngoscopie

Foregger
SS-20-129
 with four laryngoscope blades fig. 1 to 4
 complete, in case

con cuatro hojas de laringoscopio fig. 1 a 4
 completo, en estuche

avec quatre spatules a laryngoscopie fig. 1 a 4
 complet, en trousse

SS-20-130
 Case for laryngoscopes
 for 3 straight laryngoscope blades

Estuche para laringoscopios para 3 hojas
 de laringoscopio rectas

Trousse pour laryngoscopes pour 3
 spatules a laryngoscopie droites

SS-20-131
 for 4 straight laryngoscope blades
 para 4 hojas de laringoscopio rectas
 Pour 4 spatules a laryngoscopie droites

SS-20-132
 for 3 curved laryngoscope blades
 para 3 hojas de laringoscopio curvas
 Pour 3 spatules a laryngoscopie courbees

SS-20-133
 for 4 curved laryngoscope blades
 para 4 hojas de laringoscopio curvas
 Pour 4 spatuels a laryngoscopie courbees



SS-20-136
 Spare bulb
 large, for blades, fig. 2 to 4

Bombilla de recambio
 grande, para hojas fig. 2 a 4

Ampoule de rechange grand,
 pour spatule fig. 2 a 4



SS-20-137
 small, for blades fig. 0 to 1
 pequeno, para hojas fig. 0 a 1
 petit, pour spatule fig. 0 a 1



**McIntosh
SS-20-138**

with battery handle (without batteries) and
three laryngoscope blades fig. 1 to 3
complete, in case

con mango de pilas (sin pilas) y
tres hojas laringoscopio fig. 1 a 3
completo, en estuche

avec manche a pile (sans pile)
et trois spatules a laryngoscopie fig. 1 a 3
complet, en trousse

**McIntosh
SS-20-139**

with accumulator handle and
three laryngoscope blades fig. 1 to 3
complete, in case

con mango acumulador y
tres hojas laringoscopio fig. 1 a 3
completo, en estuche

avec manche a accumulateur
et trois spatules a laryngoscopie fig. 1 a 3
complet, en trousse

**McIntosh
SS-20-140**

with accumulator handle and
three laryngoscope blades fig. 1 to 3
complete, in case

con mango acumulador y
tres hojas laringoscopio fig. 1 a 3
completo, en estuche

avec manche a accumulateur
et trois spatules a laryngoscopie fig. 1 a 3
complet, en trousse

**McIntosh
SS-20-141**

with accumulator handle and
four laryngoscope blades fig. 1 to 4
complete, in case

con mango acumulador y
cuatro hojas de laringoscopio fig. 1 a 4
completo, en estuche

avec manche a accumulateur
et trois spatules a laryngoscopie fig. 1 a 4
complet, en trousse



SS-20-142
Fig. 0
for babies
para neonatales
pour nourrissons

Working length
largo util
Longueur utile
55 mm



SS-20-143
Fig. 1
for children
para ninos
pour enfants

Working length
largo util
Longueur utile
70 mm



SS-20-144
Fig. 2
for adolescents
para adolescentes
pour adolescents

Working length
largo util
Longueur utile
80 mm



SS-20-145
Fig. 3
for women
para mujeres
pour femmes

Working length
largo util
Longueur utile
105 mm



SS-20-146
Fig. 4
for men
para hombres
pour hommes

Working length
largo util
Longueur utile
130 mm

McIntosh



Foregger

SS-20-147

with battery handle (without batteries) and three laryngoscope blades fig. 2 a 4 complete, in case

con mango de pilas (sin pilas) y tres hojas laringoscopio fig. 2 a 4 completo, en estuche

avec manche a pile (sans pile) pour trois spatules a laryngoscopie fig. 2 a 4 complet, en trousse

Foregger

SS-20-149

with battery handle (without batteries) and four laryngoscope blades fig. 1 to 4 complete, in case

con mango de pilas (sin pilas) y cuatro hojas laringoscopio fig. 1 a 4 completo, en estuche

avecmanche a pile (sans pile) pour quatre spatules a laryngoscopie fig. 1 a 4 complet, en trousse

Foregger

SS-20-148

with accumulator handle and three laryngoscope blades fig. 2 to 4 complete, in case

con mango acumulador y tres hojas laringoscopio fig. 2 a 4 completo, en estuche

avecmanche a accumulateur pour trois spatules a laryngoscopie fig. 2 a 4 complet, en trousse

Foregger

SS-20-150

with accumulator handle and four laryngoscope blades fig. 1 to 4 complete, in case

con mango acumulador y cuatro hojas laringoscopio fig. 1 a 4 completo, en estuche

avec manche a accumulateur pour quatre spatules a laryngoscopie fig. 1 a 4 complet, en trousse



**Miller
SS-20-151**
with battery handle (without batteries) and
three laryngoscope blades fig. 1 to 3
complete, in case

con mango de pilas (sin pilas) y
tres hojas de laringoscopio fig. 1 a 3
completo, en estuche

avec manche a pile (sans pile) pour
trois spatules a laryngoscopie fig. 1 a 3
complet, en trousse

**Miller
SS-20-153**
with battery handle (without batteries) and
four laryngoscope blades fig. 1 to 4
complete, in case

con mango de pilas (sin pilas) y
cuatro hojas de laringoscopio fig. 1 a 4
completo, en estuche

avec manche a pile (sans pile)
pour quatre spatules a laryngoscopie fig. 1 a 4
complet, en trousse

**Miller
SS-20-152**
with accumulator handle and
three laryngoscope blades fig. 1 to 3
complete, in case

con mango acumulador y
tres hojas de laringoscopio fig. 1 a 3
completo, en estuche

avec manche a accumulateur
et trois spatules a laryngoscopie fig. 1 a 3
completo, en trousse

**Miller
SS-20-154**
with accumulator handle and
four laryngoscope blades fig. 1 to 4
complete, in case

con mango acumulador y
cuatro hojas de laringoscopio fig. 1 a 4
completo, en estuche

avec manche a accumulateur pour
quatre spatules a laryngoscopie fig. 1 a 4
complet, en trousse



SS-20-155
Fig. 0
for babies
para neonatales
pour nourrissons

Working length
largo util
Longueur utile
55 mm



SS-20-156
Fig. 1
for children
para ninos
pour enfants

Working length
largo util
Longueur utile
70 mm



SS-20-157
Fig. 2
for adolescents
para adolescentes
pour adolescents

Working length
largo util
Longueur utile
90 mm



SS-20-158
Fig. 3
for women
para mujeres
pour femmes

Working length
largo util
Longueur utile
110 mm



SS-20-159
Fig. 4
for men
para hombres
pour hommes

Working length
largo util
Longueur utile
135 mm



SS-20-160
Fig. 0
for babies
para neonatales
pour nourrissons

Working length
largo util
Longueur utile
55 mm



SS-20-161
Fig. 1
for children
para ninos
pour enfants

Working length
largo util
Longueur utile
80 mm



SS-20-162
Fig. 2
for adolescents
para adolescentes
pour adolescents

Working length
largo util
Longueur utile
130 mm



SS-20-163
Fig. 3
for women
para mujeres
pour femmes

Working length
largo util
Longueur utile
170 mm



SS-20-164
Fig. 4
for men
para hombres
pour hommes

Working length
largo util
Longueur utile
180 mm

Miller



SS-20-165
Battery handle
Mango de pilas
Manche a pile



SS-20-166
Battery handle slim, for F.O.
Laryngoscope blades with xenon
bulb, 2,5 v

Mango de pilas delgado, para
mango de laringoscopio luz fria
con bombilla de xenon, 2,5 v

Manche a pile gracile, pour spatule a
laryngoscopie avec
lumiere froide avec lampe xenon, 2,5 v



SAPTESTAR

Manufacturer & Exporter Of Surgical, Dental & Veterinary Instruments



Otology 21

21 Otology

Allport Incus Hook	63	Guiford-Wright	71
Attic Dissectr	67	Guilford-Wright Double	49
Austin Duckbill Knife	100	Guilford-Wright Drum-knife	101
Austin Duckbill	45	Guilford-Wright Footplate	71
Austin Pick	52,53	Guilford-Wright Stapes	56
Austin Sickle	45	Guilford-Wright	30,48
Ball End Elevator	96	Hajek-Ballenger	97
Barbara Pick	82	Halle Elevator	95
Bellcci Ear	26	Harmann	33
Bellucci Pick	55,56	Hartman-Herzfeld	28
Beyer	25	Hartmann	18,19,32
Billeau Ear Loop	37	Haberman	96
Boucheron	18	Henner Elevator	95
Boies Nasal	99	Holmgreen	21
Buck Ear Curette	34,35	Hook	79
Canal Elevatoi	86	Hough Crura	29
Canal Incision Knife	86	Hough Curette	38
Citelli	25	Hough Excavator	80
Cleft Palate	100	Hough Fascia Knife	46
Converse Skin Hook	64,65	Hough Incision	46
Converse-Mckenty	98	Hough Pick	54,55
Cottle Single Hook	64	Hough Whirly Bird	46,47
Cottle Skin Elevator	99	Hough	73
Curette	72,78	House Alligator	26,30
Day Ear Hook	61	House Barbara Pick	57
Derlacki Mobilizer	75	House Crabtree Dissector	85
Derlacki Ossecle	13	House Crabtree	59
Disposable Blades	43	House Curette	39,40
Double-End Curette	70,40	House Detachable Blade	43
Drum Scraper	70,75	House Elevator	94,101,102
Duckbill Ear Forcep	26	House Hook	63
Duckbill Knife Elevator	66	House Lancet	50
Dunning Elevator	97	House Miniature	27,28,29
Ear Knife Handle	43	House Obtuse Pick	57
Ear Knife Set	42	House Oval Window Pick	57,58
Elevator Chisel	76	House Oval	28
Elevator Type Knife	70	House Pick	58,59,84
Elevator	76	House Sickle	50
Endaural Curette	38	House Stapes	40
Excavtor	73,66	House Strut Pick	58
Farrior	20	House Teflon Coated	102
Fascia Knife	75	House Tympanoplasty	40,49,85
Fenestra Hook	93	House	26
Flsch	22,23,24	House-Billeau Ear Loop	38
Folding Ear Knife	42	House-Buck Curette	38,37
Footplate Chisel	81	House-Dieters	29
Footplate Hook	92	Incodostapedial Joint	77,89
Footplate Pick	87	Jordan Calal Incision	49
Fowler Double-End	40	Jordon Canal	101
Fracture Elevator	99	Joseph Double Hook	65
Freer Septum	96	Joseph Single Hook	65
Friesner Ear Knife	43	Joseph	98
Gillies Zygoma	99	Juers Crimper	30
Goldman Displacer	99	Kleinsasser	24
Goldman Single Hook	64	Knife Curette	90
Goodhill Ear	26	Kos Crimper	30,59
Gorney Septum	95	Lancet Knife	77
Greven	27	Lempert Elevator	95

21 Otology

Levers Vent Tube	31	Strut Caliper	80
Lillie Ear Hook	62	Strut Pick	83
Louisville Elevator	100	Suction Elevator	96
Louisville Skin Hook	41	Suraci Zygoma Hook-elevator	61
Lucae	33	Tabb Flap	47
Martin	32	Tenzel Double-periosteal	94
Martin-Alloy	32	Toynbee	18
Maumenee Iris Hook	61	Typanlasty Knife	76
Mccollough Elevator	95	Tyrell Iris Hook	61
Mcgee Crimper	30	Vienna Pattern	18
Mcgee Footplate Pick	52	Whirly Bird Knife	74
Mcgee Malleus	30	Wire Strut Guide	81
Mckenty Periosteal	98	Woodson Elevator	96
Micro Bone Curette	69	Wullstein	23
Morgenstein Pick	60	Wundepreizer, Volle	24
Myringotomy Knife	44,77	Zollner	21
Needle	78,79,91,92	Zygoma Elevator	99
Noyes Ear Forcep	26		
Oval Window Pick	82,83,88		
Paparella Elevator	101		
Paparella Incudostapedial	45		
Pennington Elevator	97		
Perforating Needle	88		
Perkins Elevator	100		
Pick	66,68,72,86,90,91		
Pierce Elevator	97		
Pollitzer	18		
Rasp-Caliper	89		
Roger Elevator	97		
Roller Knife	70,92		
Rosen Knife-Curette	47		
Rosen Pick	53		
Royce Ear Knife	45		
Scheer Crimper	30		
Scheer Pick	60		
Schuknecht Crimper	30		
Schuknecht Footplate	62		
Schuknecht Roller1	48		
Sempert Elevator	95		
Shambaugh	63,101		
Shapleigh Curette	36		
Shea Fenestra Hook	62		
Shea Pick	56		
Sheath Handle Ear Knife	42		
Sheehy Knife Curette	79,80		
Sheehy Ossicle	31		
Sheehy-House Knife-Curette	39,51		
Sheehy-House	52		
Sickle Kinfe	51,77,89		
Silverstein Sickle	52		
Single Skin Hook	63		
Stapes Curette	78		
Stapes Hook	92		
Stapes Pick	70		
Storz Ear	27,28		
Storz Ear	27		
Storz Otologic	28		
Struempel Ear	81		

Ohrtrichter













POLITZER
Ohrtrichter für Kinder

	SS-21-101	Ø 2.0 mm
	SS-21-102	Ø 3.0 mm
	SS-21-103	Ø 4.0 mm
	SS-21-104	Ø 5.0 mm



HARTMANN
Ohrtrichter

	SS-21-105	Ø 1.0 mm
	SS-21-106	Ø 2.0 mm
	SS-21-107	Ø 3.0 mm
	SS-21-108	Ø 3.5 mm
	SS-21-109	Ø 4.0 mm
	SS-21-110	Ø 5.0 mm
	SS-21-111	Ø 5.5 mm
	SS-21-112	Ø 6.0 mm
	SS-21-113	Ø 6.5 mm
	SS-21-114	Ø 7.0 mm









TOYNBEE
Ohrtrichter

	SS-21-115	Ø 2.0 mm
	SS-21-116	Ø 3.0 mm
	SS-21-117	Ø 4.0 mm
	SS-21-118	Ø 5.0 mm







BOUCHERON
Ohrtrichter

	SS-21-119	Ø 3.0 mm
	SS-21-120	Ø 4.0 mm
	SS-21-121	Ø 5.0 mm
	SS-21-122	Ø 6.0 mm
	SS-21-123	Ø 7.0 mm
	SS-21-124	Ø 8.0 mm
	SS-21-125	Ø 9.0 mm

Ohrtrichter



HARTMANN
Ohrtrichter , oval

	SS-21-126	1.5 x 2.5 mm
	SS-21-127	2.5 x 3.5 mm
	SS-21-128	4.5 x 5.5 mm
	SS-21-129	5.0 x 6.0 mm
	SS-21-130	5.5 x 6.5 mm









HARTMANN
Ohrtrichter zur
Nachbehandlung

	SS-21-131	Ø 8.0 mm
	SS-21-132	Ø 9.0 mm









HARTMANN
Ohrtrichter, schwarz

	SS-21-133	3.0 mm
	SS-21-134	4.0 mm
	SS-21-135	5.0 mm
	SS-21-136	7.0 mm
	SS-21-137	8.0 mm
	SS-21-138	9.0 mm

Ohrtrichter











FARRIOR
Ohrtrichter

SS-21-139		Ø 3.3 mm
SS-21-140		Ø 4.3 mm
SS-21-141		Ø 4.8 mm
SS-21-142		Ø 5.3 mm
SS-21-143		Ø 5.8 mm
SS-21-144		Ø 6.3 mm
SS-21-145		Ø 6.7 mm
SS-21-146		Ø 7,2 mm
SS-21-147		Ø 7,7 mm











FARRIOR
Ohrtrichter, oval

SS-21-148		3.0 x 4.0 mm
SS-21-149		4.0 x 5.0 mm
SS-21-150		4.5 x 5.5 mm
SS-21-151		5.0 x 6.0 mm
SS-21-152		5.5 x 6.5 mm
SS-21-153		6.0 x 7.0 mm
SS-21-154		6.5 x 7.5 mm
SS-21-155		7.0 x 8.0 mm
SS-21-156		7.5 x 8.5 mm











FARRIOR
Ohrtrichter, oval,
20 schrage

SS-21-157		3.0 x 4.0 mm
SS-21-158		4.0 x 5.0 mm
SS-21-159		4.5 x 5.5 mm
SS-21-160		5.0 x 6.0 mm
SS-21-161		5.5 x 6.5 mm
SS-21-162		6.0 x 7.0 mm
SS-21-163		6.5 x 7.5 mm
SS-21-164		7.0 x 8.0 mm
SS-21-165		7.5 x 8.5 mm



FARRIOR
Ohrtrichter, oval,
35 schrage

SS-21-166		3.0 x 4.0 mm
SS-21-167		4.0 x 5.0 mm
SS-21-168		4.5 x 5.5 mm
SS-21-169		5.0 x 6.0 mm
SS-21-170		5.5 x 6.5 mm
SS-21-171		6.0 x 7.0 mm
SS-21-172		6.5 x 7.5 mm
SS-21-173		7.0 x 8.0 mm
SS-21-174		7.5 x 8.5 mm

SS-21-175  Ø 4 mm

SS-21-176  Ø 5 mm

SS-21-177  Ø 6 mm

SS-21-178  Ø 2.0 mm

SS-21-179  Ø 4.0 mm

SS-21-180  Ø 6.0 mm



HOLMGREEN
Endaural-Spekulum,
selbsthaltend

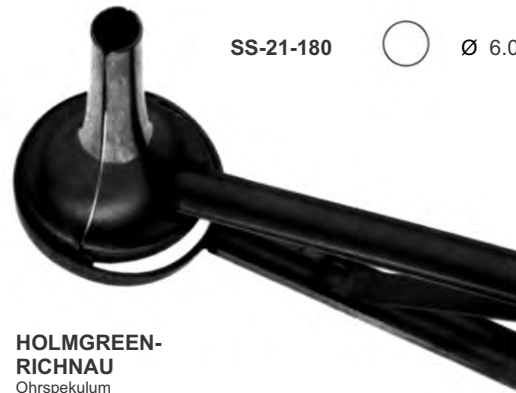

**HOLMGREEN-
RICHNAU**
Ohrspekulum

SS-21-181  4.5 x 5.5 mm

SS-21-182  5.5 x 6.5 mm

SS-21-183  6.5 x 7.5 mm

SS-21-184  7.5 x 8.5 mm

SS-21-185  8.5 x 9.5 mm

SS-21-186  9.5 x 10.5 mm



ZOLLNER
Ohrtrichter,
oval, schwarz eloxiert

Retractors



FISCH
SS-21-188



FISCH
SS-21-189
3 x 4 Teeth
25 cm

Retractors



WULLSTEIN
SS-21-190
3 x 3
13 cm



FISCH
SS-21-191
2 x 2 Teeth sharp
13 cm



WULLSTEIN
SS-21-192
3 x 3 Teeth sharp
11 cm



SS-21-193
13 cm 2 x 2 Teeth sharp



FISCH
SS-21-194
3 x 3 Teeth
13 cm

Retractors



FISCH
SS-21-195
 Modell, 3 x 3 Teeth
 11 cm



KLEINSASSER
SS-21-196
 16 cm



Wundspreizer, volle
SS-21-197
 16 cm



Wundspreizer
SS-21-198
 16 cm



FISCH
SS-21-199
 3 x 3 Teeth
 16 cm

FISCH
SS-21-200
 3 x 3 Teeth
 16 cm

Mastoid Rongeurs



Beyer
SS-21-201
2 mm cut



Beyer
SS-21-202
1 mm cut



Citelli
SS-21-203
3 mm cut

Micro- Alligator



NOYES EAR FORCEPS

SS-21-204
6 mm serrated jaws
Length of shaft 77 mm
overall length 140 mm, 5.5 inches



NOYES EAR FORCEPS

SS-21-205
1 x 2 teeth
7mm serrated jaws
Length of shaft 77 mm
Overall length 140 mm, 5.5 inches



HOUSE STRUT

SS-21-209
6 mm smooth jaws
Length of shaft 73 mm
Overall length 135 mm, 5.3 inches



DUCKBILL EAR FORCEPS

SS-21-206
Extra flat
8 mm serrated jaw with rounded tip
Length of shaft 77 mm
Overall length 138 mm, 5.4 inches



HOUSE FORCEPS

SS-21-210
6 mm serrated jaws
side opening to right
Length of shaft 73 mm
Overall length 132 mm, 5.2 inches



BELLUCCI EAR FORCEPS

SS-21-207
8 mm serrated jaws
Length of shaft 75 mm
Overall length 135 mm, 5.3 inches



GOODHILL EAR FORCEPS

SS-21-208
5 mm serrated jaws
Length of shaft 76 mm
Overall length 135 mm, 5.3 inches



HOUSE ALLIGATOR AND CRIMPER FORCEPS

SS-21-211
Very flat 8 mm serrated tapered jaws to a dull point
Length of shaft 73 mm
Overall length 130 mm, 5.1 inches



STORZ EAR FORCEPS

SS-21-212
5 mm finely serrated jaws
Length of shaft 74 mm
Overall length 136 mm, 5.4 inches



STORZ EAR FORCEPS

SS-21-215
4 mm finely serrated jaws
Angled up
Length of shaft 72 mm
Overall length 134 mm, 5.3 inches



HOUSE MINIATURE FORCEPS

SS-21-213
Extremely delicate
4 mm finely serrated jaws
Length of shaft 73 mm
Overall length 134 mm, 5.3 inches



GREVEN EAR FORCEPS

SS-21-216
5 mm jaws with 2.5 mm of tips serrated and touching
Opening behind tip
Length of shaft 73 mm
Overall length 135 mm, 5.3 inches



STORZ OTOLOGIC MICRO-ALLIGATOR FORCEPS

SS-21-214
Miniature ear forceps
3.5mm jaws



Micro-Cup



SS-21-217
2.5 mm x 6 mm flat cups
1mm x 3mm curette opening
Length of shaft 73 mm
Overall length 137 mm, 5.4 inches

**STRUEMPEL EAR
FORCEPS**



SS-21-218
1.5 mm cups
Length of shaft 71 mm
Overall length 130 mm, 5.1 inches

**HARTMAN-HERZFELD
EAR FORCEPS**



SS-21-219
3 mm cups
Length of shaft 78 mm
Overall length 137 mm, 5.4 inches

**HARTMAN-HERZFELD
EAR FORCEPS**



SS-21-220
2 mm unbiting cups
Length of shaft 78 mm
Overall length 138 mm, 5.4 inches

**HARTMAN-HERZFELD
EAR FORCEPS**



SS-21-221
0.9 mm cups
Angled right 15 degrees
Length of shaft 71 mm
Overall length 130 mm, 5.1 inches

**HOUSE OVAL
CUP FORCEPS**



SS-21-222
0.9 mm cups
Angled left 15 degrees
Length of shaft 71 mm
Overall length 134 mm, 5.3 inches

**HOUSE OVAL
CUP FORCEPS**



SS-21-223
Extra fine
0.9 mm x 2 mm cups
Length of shaft 72 mm
Overall length 134 mm, 5.3 inches

STORZ EAR FORCEPS



SS-21-224
0.7 mm x 1 mm fenestrated cups
Length of shaft 73 mm
Overall length 134 mm, 5.3 inches

STORZ EAR FORCEPS



SS-21-225
0.6 mm x 1 mm cups
Length of shaft 73 mm
Overall length 130 mm, 5.1 inches

**HOUSE MINIATURE
EAR FORCEPS**

Micro-Cup



SS-21-226
0.6 mm x 1 mm cups
Angled left 15 degrees
Length of shaft 72 mm
Overall length 130 mm, 5.1 inches

**HOUSE MINIATURE
EAR FORCEPS**



SS-21-228
0.75 mm cups
Length of shaft 71 mm
Overall length 133 mm, 5.2 inches

STORZ EAR FORCEPS



SS-21-227
0.6 mm x 1 mm cups
Angled right 15 degrees
Length of shaft 72 mm
Overall length 130 mm, 5.1 inches

**HOUSE MINIATURE
EAR FORCEPS**

Micro-Nipper



SS-21-229
3 mm jaws
Angled right 45 degrees
Length of shaft 71mm
Overall length 130 mm, 5.1 inches

**HOUGH CRURA
NIPPER FORCEPS**



SS-21-230
3 mm jaws
Angled right 45 degrees
Length of shaft 71 mm
Overall length 130 mm, 5.1 inches

**HOUGH CRURA
NIPPER FORCEPS**



SS-21-231
2 mm jaws
Length of shaft 75 mm
Overall length 127 mm, 5.0 inches

**HOUSE-DIETERS
MALLEUS NIPPER**



SS-21-232
1.5 mm jaws
Length of shaft 67 mm
Overall length 126 mm, 5.0 inches

**HOUSE-DIETERS
MALLEUS NIPPER**

Micro-Cup



SS-21-233
Short 3 mm jaws angled slightly downward
Limited closure
Length of shaft 72 mm
Overall length 130mm, 5.1 inches

**McGEE CRIMPER OR
WIRE CLOSURE
FORCEPS**



SS-21-234
3 mm jaws
Designed to crimp incus replacement
prosthesis around the malleus
Length of shaft 74 mm
Overall length 133 mm, 5.2 inches

**McGEE MALLEUS
CRIMPER OR WIRE
CLOSURE FORCEPS**



SS-21-238
7 mm serrated jaws
Length of shaft 72 mm
Overall length 133 mm, 5.2 inches

**GUILFORD-WRIGHT
LOOP SPREADER
FORCEPS**



SS-21-235
6 mm serrated jaws with concave tip to aid
in manipulating strut
Offset to left for improved vision
Length of shaft 75 mm
Overall length 134 mm, 5.2 inches

**JUERS CRIMPER
FORCEPS**



SS-21-239
Very flat 8 mm serrated jaws tapered to
a dull point
Length of shaft 73 mm
Overall length 130 mm, 5.1 inches

**HOUSE ALLIGATOR
AND CRIMPER
FORCEPS**



SS-21-236
6 mm serrated jaws with concave tip to aid
in manipulating strut
Offset to right for improved vision
Length of shaft 75 mm
Overall length 135 mm, 5.3 inches

**JUERS CRIMPER
FORCEPS**



SS-21-240
3 mm jaws
Limited closure
Length of shaft 72 mm
Overall length 132 mm, 5.2 inches

**KOS CRIMPER
FORCEPS**



SS-21-237
6 mm smooth jaws
Length of shaft 73 mm
Overall length 132 mm, 5.2 inches

**SCHUKNECHT WIRE
CRIMPER**



SS-21-241
5 mm smooth jaws have a single length-
wise groove in the lower jaw and a "V"
notch in the tip of both jaws to aid in
positioning wire prosthesis
Length of shaft 72 mm
Overall length 130 mm, 5.1 inches

**SCHEER CRIMPER
FORCEPS**

Micro Clamps-Ossicle Holdine

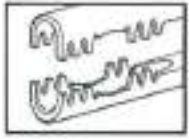

**DERLACKI OSSICLE
HOLDING CLAMP**

SS-21-242
1 mm teeth
1.5 mm x 4 mm vertical groove
1.5 mm x 2 mm horizontal groove



Thumbscrew



**SHEEHY OSSICLE
HOLDING CLAMP**

SS-21-243
5 mm Teeth
1.5 mm x 4 mm vertical grooves
8mm from tip to end of serrations



Thumbscrew
Overall length 121mm, 4.8 inches

Micro-Otological Vent Tube Introducers



**LEIVERS VENT TUBE
INTRODUCER
FORCEPS**

SS-21-244
Delicate
Lower jaw in the form of a 2.5 mm rod to fit
into the vent tube
6 mm movable upper jaw is concave on
the underside to securely but gently grasp
vent tube
Length of shaft 73 mm
Overall length 136 mm, 5.4 inches



Tuning Forks



Martin
SS-21-245
 c 128



Martin
SS-21-246
 C¹ 256



Martin-Alloy
SS-21-247
 C² 512



Martin-Alloy
SS-21-248
 C³ 1024



Martin-Alloy
WI-21-249
 C⁴ 2048



Hartmann
SS-21-250
 C 128



Hartmann
SS-21-251
 C¹ 256



Hartmann
SS-21-252
 C² 512



Hartmann
SS-21-253
 C³ 1024



Hartmann
WI-21-254
 C⁴ 2048



Hartmann
WI-21-255
 C⁵ 4096

Tuning Forks



Lucae
 SS-21-256
 C 128



Lucae
 BC21-257
 C 256



Lucae
 SS-21-258
 C 512



Lucae
 SS-21-259
 C 1024



Lucae
 SS-21-260
 C 2048



Lucae
 SS-21-261
 C 4096



Lucae



SS-21-262
 C 128
 movable up to h



Hartmann



SS-21-263
 C 128
 movable up to h



Hartmann
 BC21-264
 C 256

Curettes, Basic

Blunt



SS-21-265
1 mm diameter
slightly angled tip

BUCK EAR CURETTE



Round handle
Overall length 151 mm, 6.0 inches

Blunt



SS-21-266
1.5 mm diameter
slightly angled tip
Round handle
Overall length 152 mm, 6.0 inches

BUCK EAR CURETTE



Round handle
Overall length 151 mm, 6.0 inches

Blunt



SS-21-267
3 mm diameter
slightly angled tip
Round handle
Overall length 153 mm, 6.0 inches

BUCK EAR CURETTE

Blunt



SS-21-268
2 mm diameter
slightly angled tip
Round handle
Overall length 152 mm, 6.0 inches

BUCK EAR CURETTE



Round handle
Overall length 151mm, 6.0 inches

Blunt



SS-21-269
2.5 mm diameter
slightly angled tip
Round handle
Overall length 153 mm, 6.0 inches

BUCK EAR CURETTE

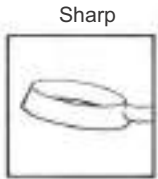

SS-21-270
1 mm diameter
slightly angled tip



Round handle
Overall length 151 mm, 6.0 inches

BUCK EAR CURETTE

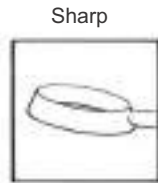

SS-21-271
1.5 mm diameter
slightly angled tip
Round handle
Overall length 152 mm, 6.0 inches



Round handle
Overall length 151 mm, 6.0 inches

BUCK EAR CURETTE

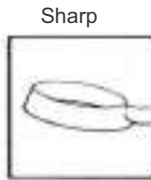

SS-21-272
2 mm diameter
slightly angled tip
Round handle
Overall length 152 mm, 6.0 inches



Round handle
Overall length 151 mm, 6.0 inches

BUCK EAR CURETTE

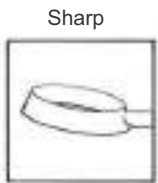

SS-21-273
2.5 mm diameter
slightly angled tip
Round handle
Overall length 153 mm, 6.0 inches



Round handle
Overall length 151 mm, 6.0 inches

BUCK EAR CURETTE

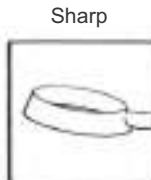

SS-21-274
3 mm diameter
slightly angled tip
Round handle
Overall length 153 mm, 6.0 inches



Round handle
Overall length 151 mm, 6.0 inches

BUCK EAR CURETTE

Otological Curettes, Basic



SHAPLEIGH EAR CURETTE

SS-21-275
 Small
 Very delicate 1.5 mm serrated loop
 Flexible shaft



Flat handle
 Overall length 163 mm, 6.4 inches

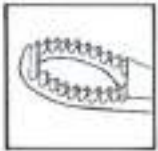

SHAPLEIGH EAR CURETTE

SS-21-276
 Large
 Very delicate 2 mm serrated loop
 Flexible shaft



Flat handle
 Overall length 163 mm, 6.4 inches



SPRAGUE EAR CURETTE

SS-21-277
 Small
 2 mm curved loop



Round handle
 Overall length 174 mm, 6.9 inches



SPRAGUE EAR CURETTE

SS-21-278
 Large
 3 mm curved loop



Round handle
 Overall length 174 mm, 6.9 inches

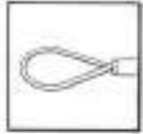

BILLEAU EAR LOOP

SS-21-279
Small
2 mm x 3 mm loop
Flexible shaft



Round handle
Overall length 161 mm, 6.3 inches



BILLEAU EAR LOOP

SS-21-280
Medium
3 mm x 5 mm loop
Flexible shaft
Round handle
Overall length 162 mm, 6.4 inches



Round handle
Overall length 161 mm, 6.3 inches

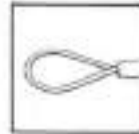

BILLEAU LOOP

SS-21-281
Large
4 mm x 7 mm loop
Flexible shaft
Round handle
Overall length 163 mm, 6.3 inches



HOUSE-BUCK CURETTE

SS-21-282
No.1
2 mm diameter
Dull curette tip



Round handle
Overall length 152 mm, 6.0 inches

Otological Curettes, Basic Continue



SS-21-283
No.2
2.5 mm diameter
Dull curette tip

HOUSE- BUCK CURETTE



Round handle
Overall length 153 mm, 6.0 inches



SS-21-284
3.5 mm oval
Teflon coated

**HOUSE-BILLEAU
EAR LOOP**



Overall length 164 mm, 6.5 inches

Otological Curettes, Endaural

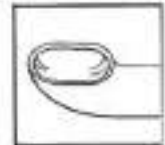

SS-21-285
1.5 mm x 3 mm cup

ENDAURAL CURETTE



Overall length 205 mm, 8.2 inches

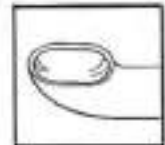

SS-21-286
2.5 mm x 4 mm cup
Overall length 205 mm, 8.2 inches

ENDAURAL CURETTE

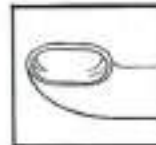

SS-21-287
3 mm x 4.5 mm cup
Overall length 205 mm, 8.2 inches

ENDAURAL CURETTE



SS-21-288
Large
2.25 mm x 3 mm serrated cup

HOUGH CURETTE



Strong angle 35 degrees
Overall length 146 mm, 5.8 inches



SS-21-289
Small
1.5 mm x 2 mm cup
Light angle, 18 degrees

**GUILFORD-WRIGHT
CURETTE**



Flat handle
Overall length 134 mm, 5.3 inches



SS-21-290
Medium
2.25 mm x 3 mm cup
Light angle, 18 degrees

**GUILFORD-WRIGHT
CURETTE**

Flat handle
Overall length 134 mm, 5.3 inches



SS-21-291
Large
2 mm x 2.5 mm cup
strong angle, 35 degrees

**GUILFORD-WRIGHT
CURETTE**

Flat handle
Overall length 134 mm,
5.3 inches



SS-21-292
2 mm diameter blade, semi sharp
straight shaft, malleable
Round handle

**SHEEHY-HOUSE
KNIFE-CURETTE**



Referred to as "Small Weapon"
Overall length 168 mm, 6.6 inches



SS-21-293
2.5 mm diameter blade, semi sharp
straight shaft, malleable
Round handle

**SHEEHY-HOUSE
KNIFE-CURETTE**



SS-21-294
Double-ended
2 mm x 2.5 mm cups and
2.25 mm x 3 mm cups

HOUSE CURETTE



Light angle cups
Flat handle with serrations
Overall length 178 mm, 7.0 inches

Otological Curettes, Micro



SS-21-295
Double-ended
2 mm x 2.5 mm cups and
2.25 mm x 3 mm cups

HOUSE CURETTE



Angled 35 degrees
Flat handle with serrations
Overall length 180 mm, 7.2 inches



SS-21-296
Double-ended
2 mm x 2.5 mm cups and
2.25 mm x 3 mm cups

**HOUSE STAPES
CURETTE**



Angled 35 degrees
Flat handle with serrations
Overall length 152 mm, 6.0 inches

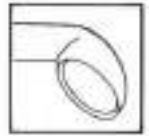

SS-21-297
2 mm cups
One end angled

**FOWLER DOUBLE-END
CURETTE**



Overall length 179 mm, 7.0 inches



SS-21-298
1 mm cup
Angled 35 degrees
Angled shaft, 10 degrees

**HOUSE
TYMPANOPLASTY
CURETTE**



Round hexagonal handle
56 mm from angle to tip
Overall length 168 mm, 6.6 inches

Plastic Surgery Curettes



Overall length 205 mm, 8.0 inches

SS-21-299
DOUBLE-END CURETTE 6 mm x 9 mm and 5 mm x 8 mm cups



SS-21-300
Fine

**LOUISVILLE
SKIN HOOK**



Overall length 162 mm, 6.5 inches



SS-21-301
Medium

**LOUISVILLE
SKIN HOOK**



Overall length 162 mm, 6.3 inches



SS-21-302

**LOUISVILLE
BONE HOOK**



Overall length 152 mm, 6.0 inches



SS-21-303
Blunt

**LOUISVILLE
VEIN HOOK**



Overall length 162 mm, 6.5 inches

Otology Knives



SS-21-304
Straight 9 mm downcutting Royce blade
Can be placed in closed handle for protection
Handle length folded 109 mm, 4.3 inches



Blade can be set automatically and rigidly at any point from straight to 40 degree angle without use of screws
Overall length 181 mm, 7.1 inches

**FOLDING
EAR KNIFE**



SS-21-305
Straight 8 mm downcutting Royce blade
Can be placed in closed handle for protection
Rigid Handle when folded and locked



Straight 8 mm downcutting blade
Handle length folded 109 mm, 4.3 inches
Overall length 190 mm, 7.5 inches

**FOLDING
HANDLE EAR KNIFE**



SS-21-306

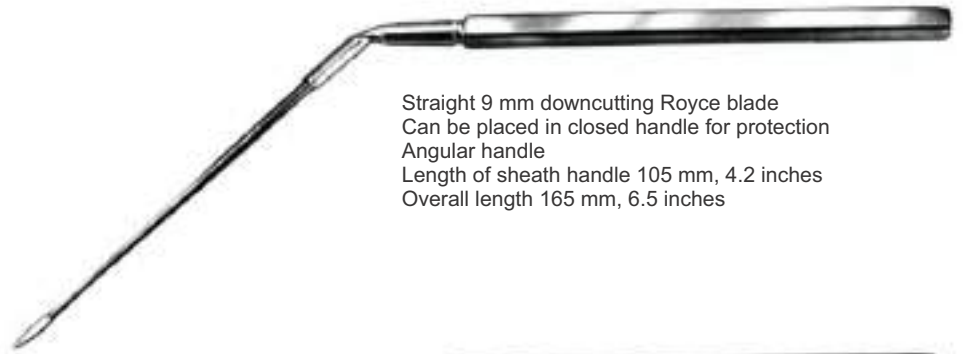

Straight 9 mm downcutting Royce blade
Can be placed in closed handle for protection
Angular handle
Length of sheath handle 105 mm, 4.2 inches
Overall length 165 mm, 6.5 inches

**SHEATH
HANDLE EAR KNIFE**



SS-21-307

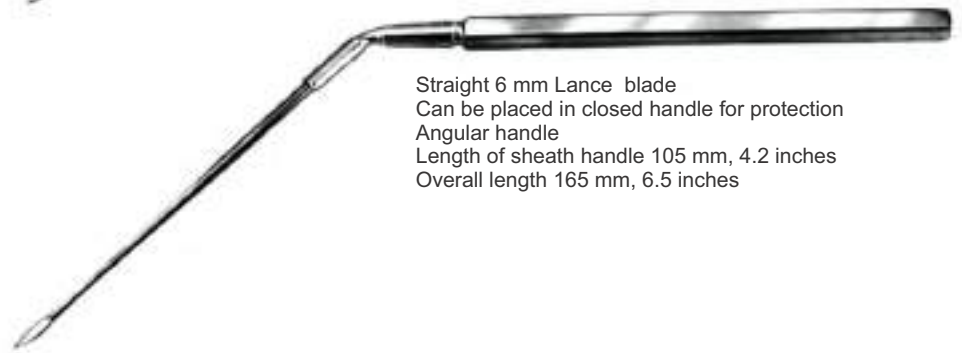

Straight 6 mm Lance blade
Can be placed in closed handle for protection
Angular handle
Length of sheath handle 105 mm, 4.2 inches
Overall length 165 mm, 6.5 inches

**SHEATH
HANDLE EAR KNIFE**



SS-21-308
Consists of 6 disposable bevel blades
and chuck handle



Malleable shafts
Overall assembled length 162 mm, 6.4 inches

**EAR
KNIFE SET**

**EAR
KNIFE HANDLE
SS-21-309**



Overall length 92 mm, 3.6 inches

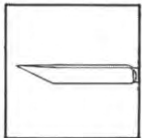

SS-21-310
3 mm disposable bevel blades
Malleable shaft

DISPOSABLE BLADES



Blades packaged 6 per package
Overall length 82 mm, 3.2 inches

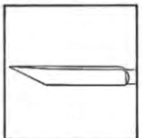

SS-21-311
4 mm disposable bevel blade
Malleable shaft

**DISPOSABLE
EAR KNIFE**



Flat spot on handle designed to guide knife in per
Overall length 165 mm, 6.5 inches

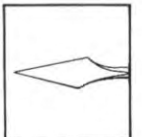

SS-21-312
3 mm disposable Lance blade
Can fit into the NO 521 Storz handle

**HOUSE DETACHABLE
BLADE**



Overall length 82 mm, 3.2 inches

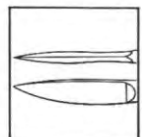

SS-21-313
9 mm blade

**FRIESNER EAR KNIFE
WITH PROTECTOR**



Overall length 152 mm, 6.0 inches

Otology Knives



SS-21-314
7 mm
upcutting Royce blade
Bayonet style shaft

ROYCE EAR KNIFE



63 mm from angle to tip
Overall length 185 mm, 7.3, inches

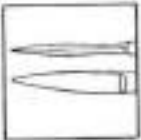

SS-21-315
7 mm downcutting Royce blade
Bayonet style shaft

ROYCE EAR KNIFE



63 mm from angle to tip
Overall length 185 mm, 7.3, inches



SS-21-316

ROYCE EAR KNIFE



8 mm down cutting Royce blade
Angled shaft
60 mm from angle to tip
Overall length 158 mm, 6.2 inches



SS-21-317
8 mm straight blade
Hexagonal handle

MYRINGOTOMY KNIFE



Overall length 166 mm, 6.5 inches



SS-21-318
9 mm slightly curved blade
Hexagonal handle

MYRINGOTOMY KNIFE



Overall length 168 mm, 6.6 inches



SS-21-319
2 mm wide curved tip
Round handle

**AUSTIN DUCKBILL
KNIFE ELEVATOR**



Overall length 160 mm, 6.3 inches



SS-21-320
3 mm curved blade
Round handle

AUSTIN SICKLE KNIFE



Overall length 160 mm, 6.3 inches



SS-21-321
0.5 mm wide x 1.5 mm long
Angled 20 degrees

**PAPARELLA
INCUDOSTAPEDIAL
JOINT KNIFE**



Octagonal handle
Overall length 163 mm, 6.4 inches



SS-21-322
5.5 mm pointed curved blade
Octagonal handle

**PAPARELLA
SICKLE KNIFE**



Overall length 163 mm, 6.4 inches



SS-21-323
Duckbill type sharp
3 mm wide x 8 mm long curved blade

**PAPARELLA
ELEVATOR KNIFE**



Octagonal handle
Overall length 163 mm, 6.4 inches

Otology Knives



SS-21-324
 Small
 2 mm diameter blade
 Angled up 45 degrees

ROSEN KNIFE-CURETTE



Round handle
 Overall length 168 mm, 6.6 inches



SS-21-325
 Large
 2.5 mm diameter blade
 Angled up 45 degrees

ROSEN KNIFE-CURETTE



Round handle
 Overall length 168 mm, 6.6 inches

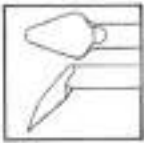

SS-21-326
 2 mm wide x 3 mm long, with rounded
 triangular tip
 Angled 45 degrees

**HOUGH INCISION
 KNIFE**



Hexagonal handle
 Overall length 150 mm, 5.9 inches



SS-21-327
 5 mm diameter blade
 Angled up 45 degrees

HOUGH FASCIA KNIFE



Hexagonal handle
 Overall length 150 mm, 5.9 inches



SS-21-328
 1 mm wide x 5 mm long, strongly curved tip,
 offset to the right

**HOUGH "WHIRLY BIRD"
 KNIFE**



Hexagonal handle
 Overall length 150 mm, 5.9 inches

Otology Knives



SS-21-329
No. 2
1 mm wide x 5 mm long, strongly curved tip,
offset to the left

**HOUGH "WHIRLY BIRD"
KNIFE**



Hexagonal handle
Overall length 150 mm, 5.9 inches



SS-21-330
No. 3
0.75 mm wide x 5 mm long, lightly curved tip,
offset to the right

**HOUGH "WHIRLY BIRD"
KNIFE**



Hexagonal handle
Overall length 150 mm, 5.9 inches



SS-21-331
No. 4
0.75 mm x 5 mm long, lightly curved tip,
offset to the left

**HOUGH "WHIRLY BIRD"
KNIFE**



Hexagonal handle
Overall length 150 mm, 5.9 inches



SS-21-332
Double-ended
0.9 mm x 1 mm blade
Angled at 25 and 45 degrees

TABB FLAP KNIFE



Round handle
Overall length 160 mm, 6.3 inches



SS-21-333
Double-ended
0.9 mm x 1 mm blade
Angled at 90 and 120 degrees

TABB FLAP KNIFE



Round handle
Overall length 160 mm, 6.3 inches

Otology Knives



SS-21-334
 3 mm diameter roller blade in line
 with handle
 Curved shaft

**SCHUKNECHT
 ROLLER KNIFE**



Flat handle
 15 mm from curve to tip
 Overall length 192 mm, 7.6 inches



SS-21-335
 3 mm diameter roller blade
 angle 90 degrees to handle
 Curved shaft

**SCHUKNECHT
 ROLLER KNIFE**



Flat handle
 15 mm from angle to tip
 Overall length 192 mm, 7.6 inches



SS-21-336
 3 mm diameter roller blade
 15 mm from angle to tip

**GUILFORD-WRIGHT
 ROLLER KNIFE**



Round handle
 Overall length 140 mm, 5.5 inches



SS-21-337
 3 mm wide tip
 Flat handle

**GUILFORD-WRIGHT
 ELEVATOR KNIFE**



Overall length 140 mm, 5.5 inches



SS-21-338
 2 mm wide tip
 Flat handle

**GUILFORD-WRIGHT
 ELEVATOR KNIFE**



Overall length 140 mm, 5.5 inches

Otology Knives



SS-21-339
7 mm strong curved blade
Round handle

**GUILFORD-WRIGHT
DOUBLE EDGE KNIFE**



Overall length 140 mm, 5.5 inches

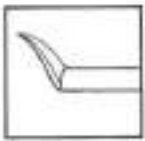

SS-21-340
1.5 mm long blade
Square handle

**GUILFORD-WRIGHT
INCUDOSTAPEDIAL KNIFE**



Overall length 140 mm, 5.5 inches



SS-21-341
2 mm x 5 mm blade
Round handle

**GUILFORD-WRIGHT
FLAP KNIFE**



Overall length 168 mm, 6.6 inches



SS-21-342
2 mm wide x 3 mm long, tapered handle
Angled 45 degrees

**JORDAN CANAL
INCISION KNIFE**



Round handle
Overall length 166mm, 6.5 inches



SS-21-343
7 mm curved blade
Round handle

**HOUSE
TYMPANOPLASTY KNIFE**



Overall length 168 mm, 6.6 inches

Otology Knives



SS-21-344
 2 mm x 3 mm tapered blade
 Referred to as "Number Two Knife"
 Angled 45 degrees

**HOUSE
 LANCET KNIFE**



Round handle
 Overall length 168 mm, 6.6 inches



SS-21-345
 0.5 mm wide x 1.5 mm long
 Angled 20 degrees

**HOUSE
 INCUDOSTAPEDIAL
 JOINT KNIFE**



Round handle
 Overall length 168 mm, 6.6 inches



SS-21-346
 0.75 mm diameter blade
 Angled 60 degrees

**HOUSE
 INCUDOSTAPEDIAL
 JOINT KNIFE**



Round handle
 Overall length 168 mm, 6.6 inches



SS-21-347
 7.5 mm curved blade
 Referred to as "Number One Knife"

**HOUSE
 SICKLE KNIFE**



Round handle
 Overall length 168 mm, 6.6 inches



SS-21-348
 3.5 mm blade
 Round handle

**HOUSE
 MYRINGOTOMY KNIFE**



Overall length 168 mm, 6.6 inches



SS-21-349
5 mm curved blade
Round handle

SICKLE KNIFE



Overall length 168 mm, 6.6 inches



SS-21-350
2 mm diameter semi-sharp blade
Referred to as "Small Weapon"
Malleable shaft

**SHEEHY-HOUSE
KNIFE-CURETTE**



Round handle
Overall length 168 mm, 6.6 inches



SS-21-351
2.5 mm diameter semi-sharp blade
Referred to as "Large Weapon"
Malleable shaft

**SHEEHY-HOUSE
KNIFE-CURETTE**



Round handle
Overall length 168 mm, 6.6 inches



SS-21-352
5 mm blade with slightly rounded tip
Round handle

**SILVERSTEIN
SICKLE KNIFE**



Overall length 180 mm, 7.1 inches



SS-21-353
1 mm diameter
Angled 33 degrees

**SILVERSTEIN
ROUND KNIFE**



Round handle
Overall length 180 mm, 7.1 inches

Otology Picks



SS-21-354
Anterior
0.2 mm long point
Angled up 90 degrees
shaft angled 20 degrees

MCGEE FOOTPLATE PICK



60 mm from angle to tip
Round handle
Overall length 165 mm, 6.5 inches



SS-21-355
Posterior
0.2 mm long point
Angled down 90 degrees
shaft angled 20 degrees

MCGEE FOOTPLATE PICK

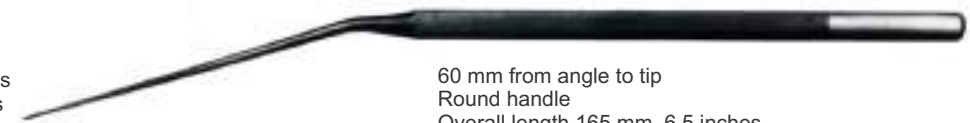

60 mm from angle to tip
Round handle
Overall length 165 mm, 6.5 inches



SS-21-356
Interior
1 mm long point
Angled down 90 degrees
shaft angled 20 degrees

MCGEE FOOTPLATE PICK



60 mm from angle to tip
Round handle
Overall length 165 mm, 6.5 inches



SS-21-357
Posterior
1 mm long point
Angled down 90 degrees
shaft angled 20 degrees

MCGEE FOOTPLATE PICK

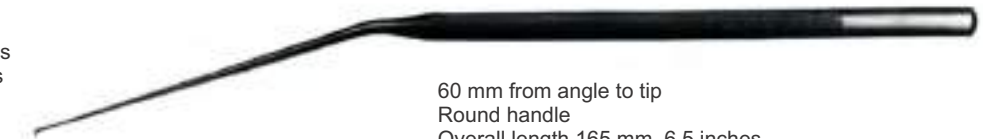

60 mm from angle to tip
Round handle
Overall length 165 mm, 6.5 inches



SS-21-358
Slightly curved tip
Round handle

AUSTIN PICK



Overall length 160 mm, 6.3 inches



SS-21-359
1 mm long tip
Angled 45 degrees

AUSTIN PICK



Round handle
Overall length 160mm, 6.3 inches



SS-21-360
3 mm long point
Angled 90 degrees

AUSTIN PICK



Round handle
Overall length 160mm, 6.3 inches



SS-21-361
1 mm long point
Angled 90 degrees

AUSTIN PICK



Round handle
Overall length 160mm, 6.3 inches



SS-21-362
Curved
3 mm curve from tip

ROSEN PICK



Round handle
Overall length 168mm, 6.6 inches



SS-21-363
Curved
1.5 mm curve from tip

ROSEN PICK



Round handle
Overall length 168mm, 6.6 inches

Otology Picks



SS-21-364
Straight point
Hexagonal handle

HOUGH PICK



Overall length 150 mm, 5.9 inches



SS-21-365
Slightly curved tip
10 mm curve from tip

HOUGH PICK



Hexagonal handle
Overall length 150 mm, 5.9 inches



SS-21-366
Light
Slightly curved tip
10 mm curve to tip

HOUGH PICK



Hexagonal handle
Overall length 150 mm, 5.9 inches

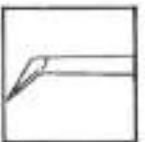

SS-21-367
0.33 mm long tip
Angled 45 degrees
50 mm from angle to tip

HOUGH PICK



Hexagonal handle, angled 15 degrees
Overall length 150 mm, 5.9 inches



SS-21-368
0.33 mm long tip
Angled 90 degrees
50 mm from angle to tip

HOUGH PICK



Hexagonal handle, angled 15 degrees
Overall length 150 mm, 5.9 inches



SS-21-369
0.66 mm long tip
Angled 90 degrees
50 mm from angle to tips

HOUGH PICK



Hexagonal handle, angled 15 degrees
Overall length 150 mm, 5.9 inches



SS-21-370
Strong curved point
Medium shaft
5 mm curve from tip

BELLUCCI PICK



Round handle
Overall length 168 mm, 6.6 inches



SS-21-371
Short curved point
Fine shaft
3 mm curve from tip

BELLUCCI PICK



Round handle
Overall length 168 mm, 6.6 inches



SS-21-372
Medium curved point
Fine shaft
7 mm curve from tip

BELLUCCI PICK



Round handle
Overall length 168 mm, 6.6 inches



SS-21-373
0.5 mm long point
Angled 90 degrees
Fine shaft

BELLUCCI PICK



Round handle
Overall length 168 mm, 6.6 inches

Otology Picks



SS-21-374
 1.0 mm long point
 Angled 90 degrees
 Fine shaft

BELLUCCI PICK



Round handle
 Overall length 168 mm, 6.6 inches



SS-21-375
 Sharp point
 3 mm curve from tip

SHEA PICK



Round handle
 Overall length 170 mm, 6.7 inches



SS-21-376
 Blunt 2 mm long tip
 Angled 35 degrees

SHEA PICK



Round handle
 Overall length 171 mm, 6.7 inches

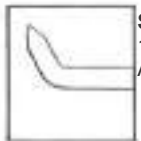

SS-21-377
 1.25 mm long tip
 Angled 40 degrees

**GUILFORD-WRIGHT
 STAPES PICK**



Round handle
 Overall length 140 mm, 5.5 inches



SS-21-378
 0.5 mm long tip
 Angled 45 degrees

**GUILFORD-WRIGHT
 FOOTPLATE PICK**



Square handle
 Overall length 140 mm, 5.5 inches

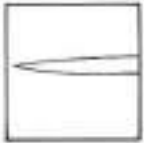

SS-21-379
Straight point
Malleable shaft

HOUSE BARBARA PICK



Round handle
Overall length 168 mm, 6.6 inches



SS-21-380
0.25 mm long point
Angled 30 degrees
Malleable shaft

HOUSE OBTUSE PICK



Round handle
Overall length 160 mm, 6.3 inches



SS-21-381
0.33 mm long point
Angled 30 degrees
Malleable shaft

HOUSE OVAL WINDOW PICK



Round handle
Overall length 168 mm, 6.6 inches



SS-21-382
0.66 mm long point
Angled 30 degrees
Malleable shaft

HOUSE OVAL WINDOW PICK



Round handle
Overall length 168 mm, 6.6 inches



SS-21-383
0.33 mm long point
Angled 90 degrees
Malleable fine shaft

HOUSE OVAL WINDOW PICK



Round handle
Overall length 168 mm, 6.6 inches

Otology Picks



SS-21-384
0.33 mm long point
Angled 90 degrees
Malleable fine shaft

**HOUSE OVAL
WINDOW PICK**



Round handle
Overall length 168 mm, 6.6 inches



SS-21-385
0.5 mm long point
Angled 90 degrees
Malleable medium shaft

HOUSE STRUT PICK



Round handle
Overall length 168 mm, 6.6 inches



SS-21-386
0.66 mm long point
Angled 90 degrees
medium shaft

HOUSE STRUT PICK



Round handle
Overall length 168 mm, 6.6 inches



SS-21-387
1 mm long point
Angled 90 degrees
Malleable heavy shaft

HOUSE PICK



Round handle
Overall length 168 mm, 6.6 inches



SS-21-388
1.5 mm long point
Angled 90 degrees
Malleable heavy shaft

HOUSE PICK



Round handle
Overall length 168 mm, 6.6 inches

Otology Picks



SS-21-389
3mm long tip
Angled 90 degrees
Malleable heavy shaft

HOUSE PICK



Round handle
Overall length 168 mm, 6.6 inches



SS-21-390
Original design
0.5 mm wide x 2.5 mm long flattened tip
Angled 90 degrees

**HOUSE CRABTREE
DISSECTOR PICK**



Referred to as the "Jimmy"
Round handle
Overall length 168 mm, 6.6 inches

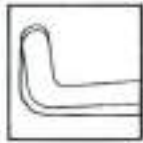

SS-21-391
Small 0.5 mm wide x 1.5 mm long, flattened tip
Angled 90 degrees

**HOUSE CRABTREE
DISSECTOR**



Round handle
Overall length 168 mm, 6.6 inches



SS-21-392
Straight point
85 mm from angle to tip

KOS PICK



Bayonet flat handle
Overall length 172 mm, 6.8 inches

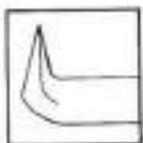

SS-21-393
0.33 mm long point
Angled up 90 degrees
85 mm from angle to tip

KOS PICK



Bayonet flat handle
Overall length 172 mm, 6.8 inches

Otology Picks



SS-21-394
 0.3 mm long point
 Angled 90 degrees
 Malleable shaft

SCHEER PICK



Hexagonal handle
 Overall length 162 mm, 6.4 inches



SS-21-395
 1 mm long point
 Angled 90 degrees
 Malleable shaft

SCHEER PICK



Hexagonal handle
 Overall length 162 mm, 6.4 inches



SS-21-396
 2 mm blunt tip
 Angled 90 degrees

MORGENSTEIN PICK



Round handle
 Overall length 164 mm, 6.5 inches



**TYRELL
IRIS HOOK**

SS-21-397
Flat serrated handle

Overall length 122 mm, 4.8 inches



**MAUMENEE
IRIS HOOK**

SS-21-398
Flat serrated handle

Overall length 125 mm, 4.8 inches



ORAL MAXILLOFACIAL

**SURACI ZYGOMA
HOOK-ELEVATOR**



SS-21-399
Overall length 228 mm, 9.0 inches

OTOLOGIC, BASIC



DAY EAR HOOK

SS-21-400
Extra small
1 mm blunt tip
Angled 90 degrees

Round handle
Overall length 159 mm, 6.3 inches



DAY EAR HOOK

SS-21-401
Small
2 mm blunt tip
Angled 90 degrees
Round handle
Overall length 159 mm, 6.3 inches

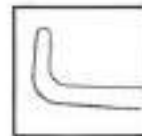

DAY EAR HOOK

SS-21-402
Large
2.5 mm blunt tip
Angled 90 degrees
Round handle
Overall length 159 mm, 6.3 inches

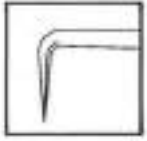

SS-21-408
1 mm tip
Angled 90 degrees

**SHAMBAUGH
AND DERLACKI
MICRO HOOK**



Flat handle
Overall length 156 mm, 6.1 inches



SS-21-409
1 mm tip
Angled left 90 degrees
Shaft angled 8 degrees

HOUSE HOOK



Round handle, malleable shaft
53 mm from angle to tip
Overall length 168 mm, 6.6 inches



SS-21-410
1 mm long tip
Angled right 90 degrees
Shaft angled 8 degrees

HOUSE HOOK



Round handle, malleable shaft
53 mm from angle to tip
Overall length 168 mm, 6.6 inches

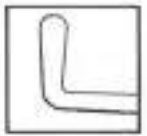

SS-21-411
3 mm tip angled 90 degrees

**ALLPORT
INCUS HOOK**



Overall length 172 mm, 6.8 inches

SOFT TISSUE



SS-21-412
Fine
Short Working end

**SINGLE
SKIN HOOK**



Overall length 125 mm, 4.9 inches

Otology Soft Tissue



SS-21-413
 Shallow curve
 Small

COTTLE SINGLE HOOK



Overall length 133 mm, 5.2 inches



SS-21-414
 Deep curve
 Small

COTTLE SINGLE HOOK



Overall length 133 mm, 5.2 inches



SS-21-415
 Deep curve
 Large

COTTLE SINGLE HOOK



Overall length 134 mm, 5.3 inches



SS-21-416

**GOLDMAN
 SINGLE HOOK**



Overall length 136 mm, 5.4 inches



SS-21-417
 Small

**CONVERSE
 SKIN HOOK**



Overall length 188 mm, 7.4 inches



SS-21-418
Large

**CONVERSE
SKIN HOOK**



Overall length 186 mm, 7.3 inches



SS-21-419

**JOSEPH
SINGLE HOOK**



Overall length 156 mm, 6.1 inches

**JOSEPH
DOUBLE HOOK
SS-21-420**
2 mm wide



Overall length 156 mm, 6.1 inches

**JOSEPH
DOUBLE HOOK
SS-21-421**
5 mm wide



Overall length 158 mm, 6.2 inches

**JOSEPH
DOUBLE HOOK
SS-21-422**
7 mm wide



Overall length 158 mm, 6.2 inches

**JOSEPH
DOUBLE HOOK
SS-21-423**
10 mm wide



Overall length 158 mm, 6.2 inches



SS-21-424
2 mm wide curved tip
Round handle
Overall length 160 mm, 6.3 inches

DUCKBILL KNIFE ELEVATOR

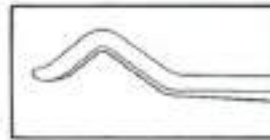

SS-21-425
0.75 mm wide tip
Angled to left
Round handle
Overall length 160 mm, 6.3 inches

EXCAVATOR

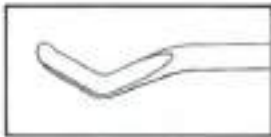

SS-21-426
0.75 mm wide tip
Angled to right
Round handle
Overall length 160 mm, 6.3 inches

EXCAVATOR

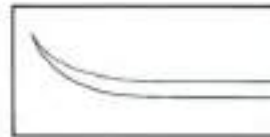

SS-21-427
Slightly curved tip
Round handle
Overall length 160 mm, 6.3 inches

PICK

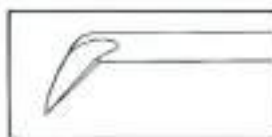

SS-21-428
1 mm long tip
Angled 45 degrees
Round handle
Overall length 160mm, 6.3 inches

PICK



SS-21-429
 3 mm long point
 Angled 90 degrees
 Round handle
 Overall length 160 mm, 6.3 inches

PICK

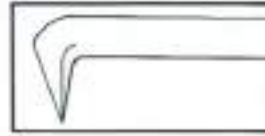

SS-21-430
 1 mm long point
 Angled 90 degrees
 Round handle
 Overall length 160 mm, 6.3 inches

PICK



SS-21-431
 5 mm flattened tip
 Angled 90 degrees
 16 mm from angled to tip
 Round handle
 Overall length 160 mm,
 6.3 inches

ATTIC DISSECTOR



SS-21-432
 3.5 mm, 4 mm, and 4.5 mm from tip
 6 mm from angle to tip
 Round handle
 Overall length 160 mm, 6.3 inches

STRUT CALIPER



SS-21-433
 3 mm curved blade
 Round handle
 Overall length 160mm, 6.3 inches

SICKLE KNIFE

Bellucci



SS-21-434
Strong curved point
Medium shaft
5 mm curve from tip
Round handle
Overall length 168 mm, 6.6 inches

PICK



SS-21-435
Short curved point
Fine shaft
4 mm curve from tip
Round handle
Overall length 168 mm, 6.6 inches

PICK

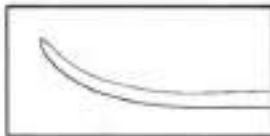

SS-21-436
Medium curved point
Fine shaft
7 mm curve from tip
Round handle
Overall length 168 mm, 6.6 inches

PICK



SS-21-437
0.5 mm long point
Angled 90 degrees
Medium shaft
Hexagonal handle
Overall length 162 mm, 6.4 inches

PICK

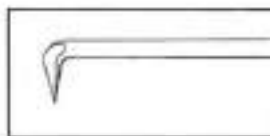

SS-21-438
0.5 mm long point
Angled 90 degrees
Fine shaft
Round handle
Overall length 168 mm, 6.6 inches

PICK



SS-21-439
1.0 mm long point
Angled 90 degrees
Fine shaft
Round handle
Overall length 168 mm, 6.6 inches

PICK



Small

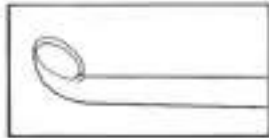

SS-21-441
 1.5 mm x 2 mm cup
 Angled 18 degrees
 Flat handle
 Overall length 134 mm, 5.3 inches

MICRO BONE CURETTE



Large

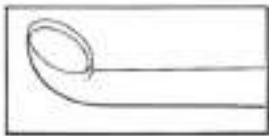

SS-21-442
 2.25 mm x 3 mm cup
 Angled 18 degrees
 Flat handle
 Overall length 134 mm, 5.3 inches

MICRO BONE CURETTE



Medium

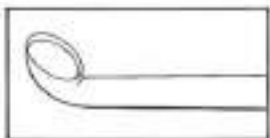

SS-21-443
 2. mm x 2.5 mm cup
 Angled 35 degrees
 Flat handle
 Overall length 134 mm, 5.3 inches

MICRO BONE CURETTE

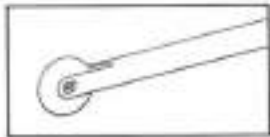

ROLLER KNIFE

SS-21-444
3 mm diameter blade
15 mm from angle to tip
Round handle
Overall length 140 mm, 5.5 inches



ELEVATOR TYPE KNIFE

SS-21-445
3 mm wide tip
Round handle
Overall length 140 mm, 5.5 inches



ELEVATOR TYPE KNIFE

SS-21-446
2 mm wide tip
Round handle
Overall length 140 mm, 5.5 inches

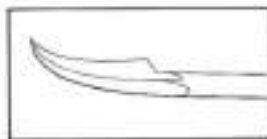

DOUBLE EDGE KNIFE

SS-21-447
7 mm long curved, pointed blade
Round handle
Overall length 140 mm, 5.5 inches

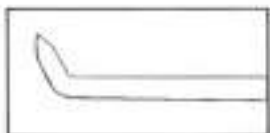

STAPES PICK

SS-21-448
1.25 mm long tip
Angled 40 degrees
Round handle
Overall length 140 mm, 5.5 inches



DRUM ELEVATOR

SS-21-449
2 mm wide
15 mm from angle to tip
Round handle
Overall length 140 mm, 5.5 inches

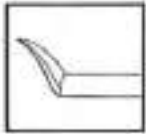

SS-21-450
1.5 mm blade
Square handle

**GUILFORD- WRIGHT
INCUDOSTAPEDIAL
KNIF**



Overall length 140 mm, 5.5 inches



SS-21-451
2 mm x 5mm blade
Round handle

**GUILFORD- WRIGHT
ELEVATOR FLAP KNIFE**



Overall length 168 mm, 6.7 inches



SS-21-452
0.5 mm long tip
Angled 45 degrees

**GUILFORD- WRIGHT
FOOTPLATE PICK**



Square handle
Overall length 140 mm, 5.5 inches



SS-21-453
1 mm wide x 4 mm long measuring
plate with 1 mm markings on both sides
Angled 65 degrees

**GUILFORD- WRIGHT
FENESTROMETER**



Malleable shaft
Round handle
Overall length 140 mm, 5.5 inches

Hough



Large

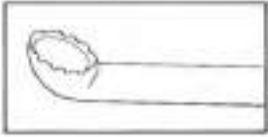

SS-21-454
2.25 mm x 3 mm serrated cup
Angled 35 degrees
Hexagonal handle
Overall length 143 mm, 5.6 inches

CURETTE

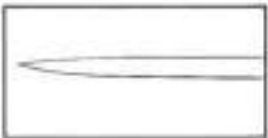

SS-21-455
Straight point
Hexagonal handle
Overall length 150 mm, 5.9 inches

PICK

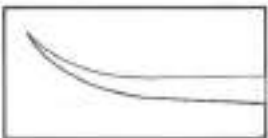

SS-21-456
Slightly curved tip
10 mm curved from tip
Hexagonal handle
Overall length 150 mm, 5.9 inches

PICK



Light

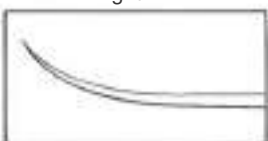

SS-21-457
Slightly curved tip
10 mm curved from tip
Hexagonal handle
Overall length 150 mm, 5.9 inches

PICK



SS-21-458
0.33 mm long tip
Angled 45 degrees
50 mm from angle to tip
Hexagonal handle, angled 15 degrees
Overall length 150 mm, 5.9 inches

PICK



SS-21-459
0.5 mm long flattened tip
Angled 45 degrees
Hexagonal handle, angled 15 degrees
Overall length 150 mm, 5.9 inches

EXCAVATOR

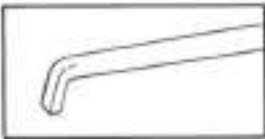

SS-21-460
Hoe
0.5 mm long tip
Angled 90 degrees
50 mm from angle to tip
Hexagonal handle, angled 15 degrees
Overall length 150 mm, 5.9 inches

EXCAVATOR

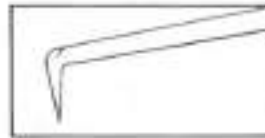

SS-21-461
0.33 mm long tip
Angled 90 degrees
50 mm from angle to tip
Hexagonal handle, angled 15 degrees
Overall length 150 mm, 5.9 inches

PICK



SS-21-462
0.66 mm long tip
Angled 90 degrees
50 mm from angle to tip
Hexagonal handle, angled 15 degrees
Overall length 150 mm, 5.9 inches

PICK

Hough

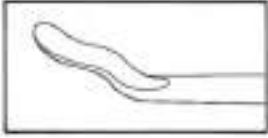

SS-21-463
No.1
1 mm wide x 5 mm long strong
curved tip, offset to the right
Hexagonal handle
Overall length 150 mm, 5.9 inches

“WHIRLY BIRD” KNIFE

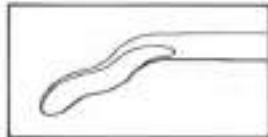

SS-21-464
No.2
1 mm wide x 5 mm long strong
curved tip, offset to the left
Hexagonal handle
Overall length 150 mm, 5.9 inches

“WHIRLY BIRD” KNIFE

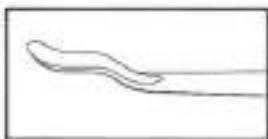

SS-21-465
No.3
0.75 mm wide x 5 mm long lightly
curved tip, offset to the right
Hexagonal handle
Overall length 150 mm, 5.9 inches

“WHIRLY BIRD” KNIFE

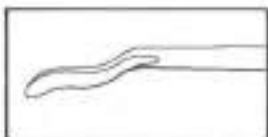

SS-21-466
No.4
0.75 mm wide x 5 mm long lightly
curved tip, offset to the left
Hexagonal handle
Overall length 150 mm, 5.9 inches

“WHIRLY BIRD” KNIFE



SS-21-467
4 prong, 2 mm diameter, curved tip
Hexagonal handle
Overall length 150 mm, 5.9 inches

DERLACKI MOBILIZER

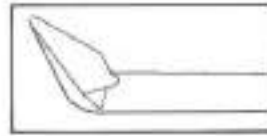

SS-21-468
2 mm wide x 3 mm long, rounded
triangular tip
Angled 45 degrees
Overall length 150 mm, 5.9 inches

INCISION KNIFE

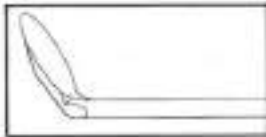

SS-21-469
5 mm diameter blade
Angled 45 degrees
Hexagonal handle
Overall length 150 mm, 5.9 inches

FASCIA KNIFE

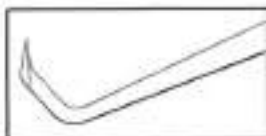

SS-21-470
0.5 mm long point on 45 degree angle,
2.5 mm long tip, angled 60 degrees
50 mm from angle to tip
Hexagonal handle, angled 15 degrees
Overall length 150 mm, 5.9 inches

DRUM SCRAPER

House

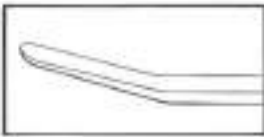

SS-21-471
1mm wide x 12 mm long tip
Angled 15 degrees
Referred to as the "Gimmick"
Round handle
Overall length 168 mm, 6.6 inches

ELEVATOR



SS-21-472
1mm wide x 12 mm long tip
Angled 15 degrees
Teflon(R) Coated
With diathermy attachment
Overall length 168 mm, 6.6 inches

COATED ELEVATOR



SS-21-473
1.5 mm wide, curved scraping tip
88 mm working length
Flat bayonet handle
Overall length 170 mm, 6.7 inches

ELEVATOR & CHISEL

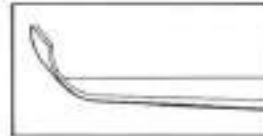

SS-21-474
1 mm wide, curved scraping tip
88 mm working length
Flat bayonet handle
Overall length 170 mm, 6.7 inches

ELEVATOR & CHISEL

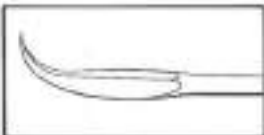

SS-21-475
7 mm curved blade
Round handle
Overall length 168 mm, 6.6 inches

TYPANOPLASTY KNIFE

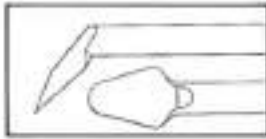

SS-21-476
2 mm x 3 mm tapered tip
Angled 45 degrees
Referred to as " Number Two Knife"
Round handle
Overall length 168 mm, 6.6 inches

LANCET KNIFE

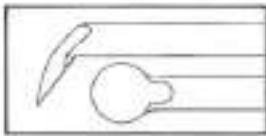

SS-21-477
0.75 mm diameter blade
Angled 60 degrees
Round handle
Overall length 168 mm, 6.6 inches

INCUDOSTAPEDIAL JOINT KNIFE



SS-21-478
0.75 mm curved blade
Referred to as " Number One Knife"
Round handle
Overall length 168 mm, 6.6 inches

SICKLE KNIFE

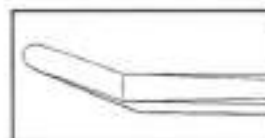

SS-21-479
0.5 mm wide x 1.5 mm long blade
Angled 20 degrees
Round handle
Overall length 168 mm, 6.6 inches

INCUDOSTAPEDIAL JOINT KNIFE

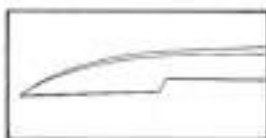

SS-21-480
3.5 mm blade
Round handle
Overall length 168 mm, 6.6 inches

MYRINGOTOMY KNIFE

House

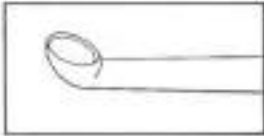

SS-21-481
Light angle
Double-ended
2 mm and 2.5 mm oval cups
Flat handle
Overall length 178 mm, 7.0 inches

CURETTE

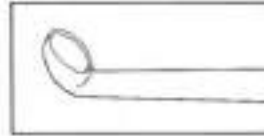

SS-21-982
Strong angle
Double-ended
2.25 mm x 3 mm and 2 mm 2.5 mm cups
Flat handle
Overall length 178 mm, 7.0 inches

CURETTE



SS-21-483
Double-ended
2.25 mm x 3 mm and 2 mm x 2.5 mm cups
Flat handle
Overall length 152 mm, 6.0 inches

STAPES CURETTE

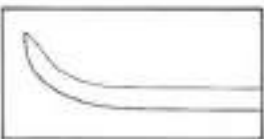

SS-21-484
Curved tip
Semi-sharp point
Malleable shaft
Round handle
Overall length 168 mm, 6.6 inches

NEEDLE



House

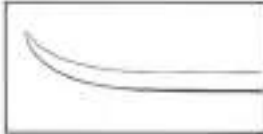

SS-21-485
Rosen type curved and slightly
dulled tip
Malleable shaft
Overall length 168 mm, 6.6 inches

NEEDLE



SS-21-486
1 mm long tip
Angled left 90 degrees
Malleable shaft, angled 8 degrees
53 mm from angle to tip
Overall length 168 mm, 6.6 inches

HOOK



SS-21-487
1 mm long point
Angled right 90 degrees
Malleable shaft, angled 8 degrees
53 mm from angle to tip
Overall length 168 mm, 6.6 inches

HOOK

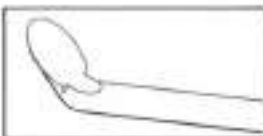

SS-21-488
2 mm diameter semi-sharp blade
Referred to as "Small Weapon"
Malleable shaft
Overall length 168 mm, 6.6 inches

SHEEHY KNIFE CURETTE

Houses

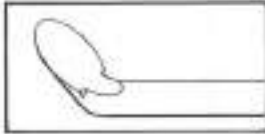

SHEEHY KNIFE CURETTE

SS-21-489
2.5 mm diameter semi-sharp blade
Referred to as "Large Weapon"
Malleable shaft
Overall length 168 mm, 6.6 inches

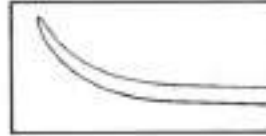

NEEDLE

SS-21-490
Rosen point (semi-sharp)
3mm curve from tip
Malleable shaft
Overall length 160 mm, 6.3 inches



HOUGH EXCAVATOR

SS-21-491
0.33 mm long tip
Angled 90 degrees
Malleable shaft
Overall length 168 mm, 6.6 inches

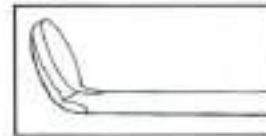

MIDDLE EAR MIRROR

SS-21-492
2 mm diameter
Angled 45 degrees
Overall length 168 mm, 6.6 inches

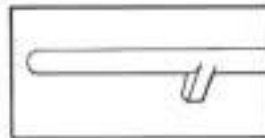

STRUT CALIPER

SS-21-493
Marker 4.5 mm from tip
Malleable shaft
Overall length 168 mm, 6.6 inches

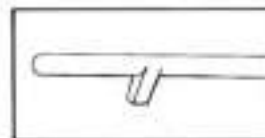

STRUT CALIPER

SS-21-494
Marker 3.5 mm from tip
Malleable shaft
Overall length 168 mm, 6.6 inches

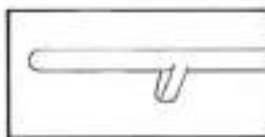

STRUT CALIPER

SS-21-495
Marker 4 mm from tip
Malleables length 168 mm, 6.6 inches
Overall length 168mm, 6.6 inches



Straight

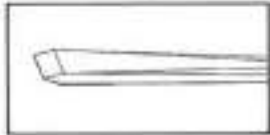

SS-21-496
0.6 mm tip
Malleable shaft, angled 10 degrees
62 mm from angle to tip
Overall length 156 mm, 6.2 inches

FOOTPLATE CHISEL

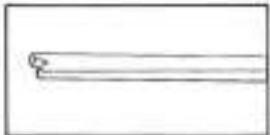

SS-21-497
0.6 mm long tip with notched end
Malleable shaft, angled 10 degrees
62 mm from angle to tip
Overall length 156 mm, 6.2 inches

WIRE STRUT GUIDE



SS-21-498
Marker 5 mm from tip
Malleable shaft
Overall length 168 mm, 6.6 inches

STRUT CALIPER

House



SS-21-499
Straight point
Malleable shaft
Overall length 168mm, 6.6 inches

BARBARA PICK

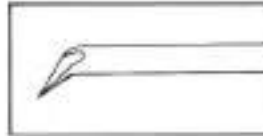

SS-21-500
0.25 mm long point
Angled 30 degrees
Malleable shaft
Overall length 160mm, 6.3 inches

OBTUSE PICK

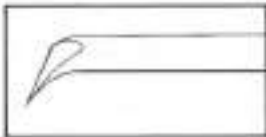

SS-21-501
0.33 mm long point
Angled 30 degrees
Malleable shaft
Overall length 168 mm, 6.6 inches

OVAL WINDOW PICK

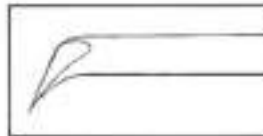

SS-21-502
0.66 mm long point
Angled 30 degrees
Malleable shaft
Overall length 168 mm, 6.6 inches

OVAL WINDOW PICK

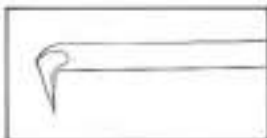

SS-21-503
0.33 mm long point
Angled 90 degrees
Malleable shaft
Overall length 168 mm, 6.6 inches

OVAL WINDOW PICK

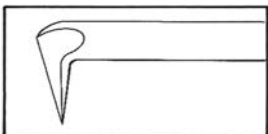
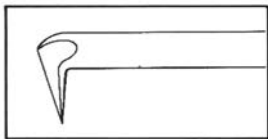
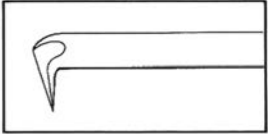

House

BC-21-504
0.33 mm long point
Angled 90 degrees
Malleable medium shaft
Overall length 168 mm, 6.6 inches

OVAL WINDOW PICK

BC-21-505
0.5 mm long point
Angled 90 degrees
Malleable medium shaft
Overall length 168 mm, 6.6 inches

STRUT PICK

BC-21-506
0.66 mm long tip
Angled 90 degrees
Malleable medium shaft
Overall length 168 mm, 6.6 inches

STRUT PICK

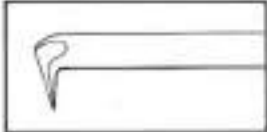

BC-21-504
0.33 mm long point
Angled 90 degrees
Malleable medium shaft
Overall length 168 mm, 6.6 inches

OVAL WINDOW PICK

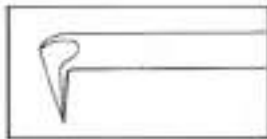

BC-21-505
0.5 mm long point
Angled 90 degrees
Malleable medium shaft
Overall length 168 mm, 6.6 inches

STRUT PICK

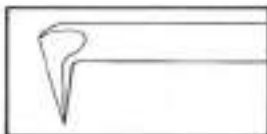

BC-21-506
0.66 mm long tip
Angled 90 degrees
Malleable medium shaft
Overall length 168 mm, 6.6 inches

STRUT PICK

House Pick



SS-21-507
1 mm long tip
Angled 90 degrees
Malleable heavy shaft

HOUSE PICK



Round handle
Overall length 168 mm, 6.6 inches



SS-21-508
1.5 mm long point
Angled 90 degrees
Malleable heavy shaft
Overall length 168 mm, 6.6 inches

HOUSE PICK



Round handle
Overall length 168 mm, 6.6 inches



SS-21-509
3 mm long tip
Angled 90 degrees
Malleable heavy shaft
Overall length 168 mm, 6.6 inches

HOUSE PICK



Round handle
Overall length 168 mm, 6.6 inches



Referred to as the "Jimmy"
Round handle
Overall length 168 mm, 6.6 inches



SS-21-510
Original design
0.5 mm wide x 2.5 mm long, flattened tip
Angled 90 degrees

**HOUSE CRABTREE
DISSECTOR PICK**



Referred to as the "Jimmy"
Round handle
Overall length 168 mm, 6.6 inches



SS-21-511
Small 0.5 mm wide x 1.5 mm long, flattened tip
Angled 90 degrees
Overall length 168 mm, 6.6 inches

**HOUSE CRABTREE
DISSECTOR PICK**



56 mm from angle to tip
Round handle
Overall length 168 mm, 6.6 inches



SS-21-512
Small
1 mm cup, angled 35 degrees
Shaft angled 10 degrees

**HOUSE
TYMPANOPLASTY
CURETTE**

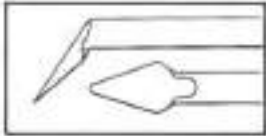

SS-21-513
2 mm wide x 3 mm long
tapered blade
Angled 45 degrees
Overall length 166 mm, 6.5 inches

CANAL INCISION KNIFE

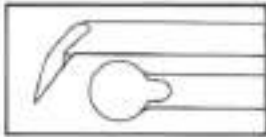

SS-21-514
2 mm diameter blade
Angled 60 degrees
Overall length 166 mm, 6.5 inches

CANAL ELEVATOR

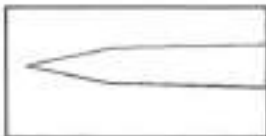

SS-21-515
Straight point
85 mm, from angle to tip
Bayonet flat handle
Overall length 172 mm, 6.8 inches

PICK



SS-21-516
0.33 mm long point
Angled up 90 degrees
85 mm, from angle to tip
Bayonet flat handle
Overall length 172 mm, 6.8 inches

PICK



Anterior

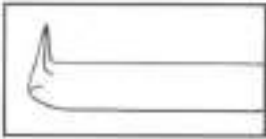

SS-21-520
0.2 mm long point
Angled up 90 degrees
shaft angled 20 degrees
60 mm from angle to tip
Overall length 165 mm, 6.5 inches

FOOTPLATE PICK



Posterior

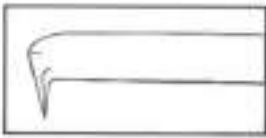

SS- 21-521
0.2 mm long point
Angled down 90 degrees
Shaft angled 20 degrees
60 mm from angle to tip
Overall length 165 mm, 6.5 inches

FOOTPLATE PICK



Anterior

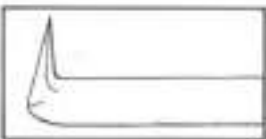

SS- 21-522
1 mm long point
Angled down 90 degrees
Shaft angled 20 degrees
60 mm from angle to tip
Overall length 165 mm, 6.5 inches

FOOTPLATE PICK



Posterior

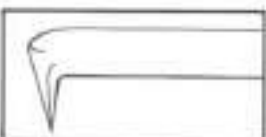

SS- 21-523
1 mm long point
Angled down 90 degrees
Shaft angled 20 degrees
60 mm from angle to tip
Overall length 165 mm, 6.5 inches

FOOTPLATE PICK



Small

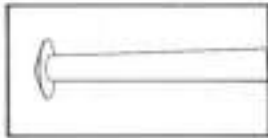

SS-21-524
 0.4 mm diameter rasp
 Shaft angled 20 degrees
 60 mm from angle to tip
 Overall length 165 mm, 6.5 inches

OVAL WINDOW RASP



Large



SS-21-525
 0.7 mm diameter rasp
 Shaft angled 20 degrees
 60 mm from angle to tip
 Overall length 165 mm, 6.5 inches

OVAL WINDOW RASP

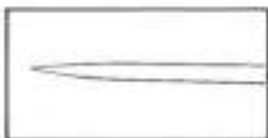

SS-21-526
 Straight point
 Shaft angled 20 degrees
 60 mm from angle to tip
 Overall length 165 mm, 6.5 inches

PERFORATING NEEDLE



SAPTESTAR
Manufacturer & Exporter Of Surgical, Dental & Veterinary Instruments

Paparella

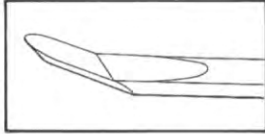

SS-21-527
0.5 wide x 1.5 mm long blade
Angled 20 degrees
Octagonal handle
Overall length 163 mm, 6.4 inches

INCUDOSTAPEDIAL JOINT KNIFE

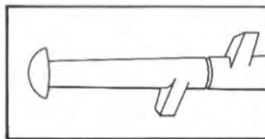

SS-21-528
Mushroom type rasp
Markers at 3.5 mm and 4.5mm
Malleable handle
Overall length 163 mm, 6.4 inches

RASP-CALIPER

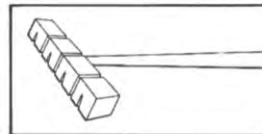

SS-21-529
1 mm wide x 4 mm long blade,
with 1 mm, markings on one side and
0.5 mm markings on the other side
Malleable shaft
Octagonal handle
Overall length 163 mm, 6.4 inches

FENESTROMETER

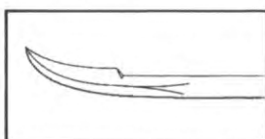

SS-21-530
5.5 mm curved, pointed blade
Octagonal handle
Overall length 163 mm, 6.4 inches

SICKLE KNIFE

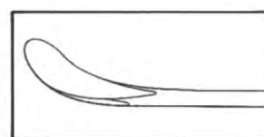

SS-21-531
3mm wide x 8 mm, long, curved
duckbill blade
Octagonal handle
Overall length 163 mm, 6.4 inches

ELEVATOR KNIFE

Rosen

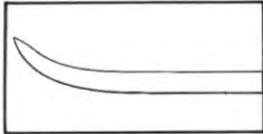

SS-21-532
 Curved
 3mm curve from tip
 Overall length 168 mm, 6.6 inches

PICK

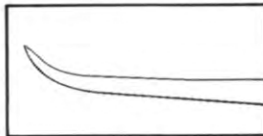

SS-21-533
 Curved
 1.5mm curve from tip
 Overall length 168 mm, 6.6 inches

PICK



Small

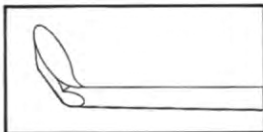

SS-21-534
 2mm diameter blade, angled up
 45 degrees
 Overall length 168 mm, 6.6 inches

PICK



Large

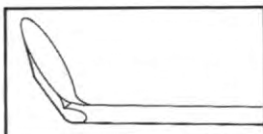

SS-21-535
 2.5mm diameter blade, angled up
 45 degrees
 Overall length 168 mm, 6.6 inches

KNIFE CURETTE



SS-21-536
Malleable shaft
Hexagonal handle
Overall length 162 mm, 6.4 inches

NEEDLE



SS-21-537
Slightly curved
6 mm curve from tip
Malleable shaft
Hexagonal handle
Overall length 162 mm, 6.4 inches

NEEDLE

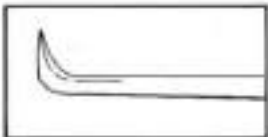

SS-21-538
0.3 mm long point
Angled 90 degrees
Malleable shaft
Hexagonal handle
Overall length 162 mm, 6.4 inches

PICK



SS-21-539
1 mm long point
Angled 90 degrees
Malleable light shaft
Hexagonal handle
Overall length 162 mm, 6.4 inches

PICK



SS-21-540
3 mm diameter blade in line with handle
Curved shaft
15 mm curve from tip
Overall length 192 mm, 7.6 inches

ROLLER KNIFE

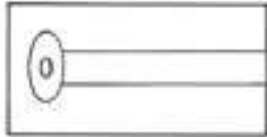

SS-21-541
3 mm diameter roller blade, angled 90 degrees to handle
Curved shaft
15 mm curve from tip
Overall length 192 mm, 7.6 inches

ROLLER KNIFE



Anterior

Posterior



SS-21-542
0.3 mm long tip
Slight upward curve
shaft angled 18 degrees
55 mm from angle to tip
Overall length 165 mm, 6.5 inches

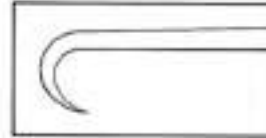

SS-21-543
0.6 mm long tip
Full downward curve
shaft angled 18 degrees
55 mm from angle to tip
Overall length 165 mm, 6.5 inches

FOOTPLATE HOOK

FOOTPLATE HOOK

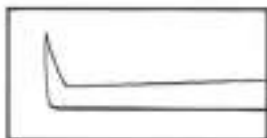

SS-21-544
1 mm long point
shaft angled 18 degrees
55 mm from angle to tip
Overall length 165 mm, 6.5 inches

STAPES HOOK

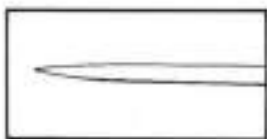

SS-21-545
shaft angled 18 degrees
55 mm from angle to tip
Overall length 165 mm, 6.5 inches

NEEDLE



SS-21-546
Sharp point
3 mm curve from tip
Overall length 171 mm, 6.7 inches

PICK

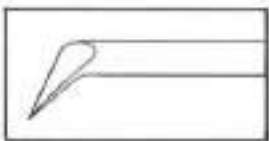

SS-21-547
1 mm long point
Angled 45 degrees
Overall length 171 mm, 6.7 inches

FENESTRA HOOK

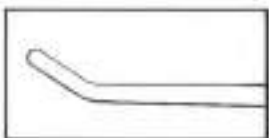

SS-21-548
Blunt 2 mm long tip
Angled 35 degrees
Overall length 171 mm, 6.7 inches

PICK

Elevators



SS-21-549
4 mm x 6mm dissector end with shaft
marked at 10 mm, 20 mm, 30,mm from tip
6 mm, wide curved elevator

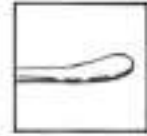

TENZEL DOUBLE-ENDED
PERIOSTEAL ELEVATOR



Round knurled handle
Overall length 195 mm, 7.7 inches

SS-21-550
ELEVATOR
Heavy
7.5 mm curved tip



Overall length 202 mm, 7.9 inches

BC -21-551
LEMPERT ELEVATOR
7 mm curved tip



Overall length 183 mm, 7.2 inches

SS-21-552
HOUSE ELEVATOR
3 mm wide
Octagonal handle



Overall length 180 mm, 7.0 inches

SS-21-553
LEMPERT ELEVATOR
Slightly angled, 2 mm wide



Overall length 175 mm, 6.8 inches

Elevators

SS-21-554
LEMPERT ELEVATOR
Slight angled, 3mm wide



Overall length 175 mm, 6.8 inches

SS-21-555
HENNER ELEVATOR
Double-ended
2 mm wide



Overall length 189 mm, 7.4 inches



SS-21-556
Double-ended
3 mm round semi sharp end and
2.75 mm elevator end

**MCCOLLOUGH
ELEVATOR**



Angled 45 degrees
Overall length 185 mm, 7.3 inches

SS-21-557
HALLE ELEVATOR
2 mm tip



Overall length 180 mm, 7.0 inches



SS-21-558
3 mm tip

**GORNEY SEPTUM
SUCTION ELEVATOR**



Overall length 216 mm, 8.5 inches

Elevators

SS-21-559
 HABERMAN
 SUCTION ELEVATOR
 2.5 mm x 4 mm opening
 Hexagonal handle



Overall length 177 mm, 7.0 inches

SS-21-560
 FREER
 SEPTUM ELEVATOR
 Double-ended
 Sharp and blunt 4.5 mm tips



Overall length 190 mm, 7.5 inches

SS-21-561
 FREER
 SEPTUM ELEVATOR
 Double-ended
 Sharp and blunt 6.5 mm tips



Overall length 195 mm, 7.6 inches



SS-21-562
 Double-ended
 4 mm x 10 mm flat edge like scraper and
 2 mm x 11 mm semi sharp top

WOODSON ELEVATOR



Overall length 176 mm, 6.9 inches



SS-21-563
 Double-ended

BALL END ELEVATOR



Overall length 190 mm, 7.4 inches

Elevators

SS-21-564

Double-ended
6 mm x 9 mm and 6 mm x 11 mm tip
PENNINGTON
ELEVATOR



Overall length 215 mm, 8.4 inches

SS-21-565

Double-ended
Semi sharp
Curved 3 mm tips
ROGER ELEVATOR



Angled right and left
Overall length 210 mm, 8.2 inches

SS-21-566

Double-ended
Blunt and semi sharp 5 mm tips
HAJEK-BALLENGER
ELEVATOR



Overall length 197 mm, 7.7 inches



SS-21-567

Double-ended
3 mm x 5 mm curette end and 3 mm
spatula end



**DUNNING ELEVATOR
& CURETTE**



Overall length 200 mm, 7.8 inches

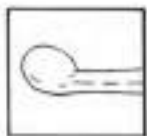

SS-21-568

Double-ended
5 mm x 7 mm tips



PIERCE ELEVATOR



Overall length 188 mm, 7.4 inches

Elevators

SS-21-569
MCKENTY
PERIOSTEAL ELEVATOR
4 mm wide tip



Overall length 124 mm, 4.8 inches

SS-21-570
MCKENTY
PERIOSTEAL ELEVATOR
5 mm wide tip



Overall length 125 mm, 4.9 inches

SS-21-571
CONVERSE-MCKENTY
PERIOSTEAL ELEVATOR
5 mm wide tip



Overall length 145 mm, 5.7 inches

SS-21-572
JOSEPH
PERIOSTEAL ELEVATOR
4 mm wide tip



Overall length 170 mm, 6.6 inches

SS-21-573
CONVERSE
PERIOSTEAL ELEVATOR
4 mm wide tip



Overall length 180 mm, 7.0 inches

Elevators

SS-21-574
GILLIES
ZYGOMA ELEVATOR
9 mm wide tip
35 mm from angle to tip



Overall length 225 mm, 8.8 inches

SS-21-575
COTTLE SKIN ELEVATOR
10 mm wide tip



Overall length 190 mm, 7.4 inches

SS-21-576
BOIES NASAL
FRACTURE ELEVATOR
9 mm wide tip



Overall length 195 mm, 7.6 inches

SS-21-577
GOLDMAN DISPLACER
SEPTUM ELEVATOR
6 mm wide tip
Gentle tapered blade



Overall length 190 mm, 7.4 inches

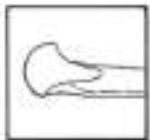

SS-21-578
Double-ended
4 mm x 4 mm round end and 3 mm
spatula end



**COTTLE
SEPTUM ELEVATOR**



Overall length 225 mm, 8.8 inches

Elevators

SS-21-579
CLEFT PALATE
ELEVATOR
4 mm x 9 mm tip



Overall length 160 mm, 6.2 inches



SS-21-580
Small
Double-ended

LOUISVILLE ELEVATOR



3 mm x 5 mm and 4 mm x 5 mm tips
Overall length 170 mm, 6.7 inches



SS-21-581
Large
Double-ended

LOUISVILLE ELEVATOR



3 mm pointed end and 5 mm angled end
Overall length 170 mm, 6.7 inches

OTOLOGIC, MICRO



SS-21-582
2 mm curved tip
Round handle

AUSTIN DUCKBILL
KNIFE-ELEVATOR



Overall length 159 mm, 6.3 inches



SS-21-583
1.25 mm x 2.5 mm blade
135 degrees back scratcher

PERKINS ELEVATOR



Round handle
Overall length 165 mm, 6.5 inches



SS-21-584
Duckbill type, sharp
3 mm x 8 mm curved blade

**PAPARELLA
ELEVATOR-KNIFE**



Octagonal handle
Overall length 163 mm, 6.5 inches



SS-21-585
2 mm
Angled 13 degrees, 15 mm from angled
to tip

**GUILFORD-WRIGHT
DRUM ELEVATOR**



Round handle
Overall length 140 mm, 5.6 inches



SS-21-586
Duckbill
3.5 mm tip

**SHAMBAUGH &
DERLACKI ELEVATOR**



Light curve
Overall length 172 mm, 6.7 inches



SS-21-587
2 mm diameter blade
Angled 60 degrees
Sharp

**JORDON
CANAL ELEVATOR**



Round handle
Overall length 166 mm, 6.6 inches

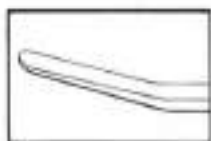

SS-21-588
1 mm x 12 mm
Angled 15 degrees
Referred to as the "Gimmick"

HOUSE ELEVATOR



Straight shaft
Round handle
Overall length 168 mm, 6.7 inches

Otology Micro



SS-21-589
 1.5 mm x 12 mm tip
 Angled 15 degrees
 coated

**HOUSE TEFLON
 COATED ELEVATOR**



With diathermy attachment
 Overall length 168 mm, 6.6 inches



SS-21-590
 1.5 curved tip
 Flat handle, bayonet type

HOUSE T ELEVATOR



88 mm from band to tip
 Overall length 170 mm, 6.7 inches



SS-21-591
 1 curved tip
 Flat handle, bayonet type

HOUSE ELEVATOR



88 mm from band to tip
 Overall length 170 mm, 6.7 inches



SAPTESTAR

Manufacturer & Exporter Of Surgical, Dental & Veterinary Instruments



Nasal 22

22 Nasal

Aiach	134	Rotating Ostrum	
Asch	131,133	Rubin	137
Aufricht	129,132	Sheehan	116,125
Ballenger	119,123	Sidebiting Antrum	126
Ballenger-Hajek	121	Silver	137
Beckmann Angled Shaft	112	Stammberger	127
Beckmann Trapezoidal Fenestrated	111	Struycken	146
Beckmann	107,112	Takahashi	145
Brunings	114,120	Tc-rubin	143
Caplan	116	Thru Cutting	116
Cinelli	125	Tieck-Halle	140,141
Converse Alar Hooklet	131	Thudichum	106
Converse	118,130,131	Troltsch	107
Cottle Columella Forcep	134	Vienna Pattern	117
Cottle Osteotomes	124	Voltoolini (duplay)	105
Cottle Saddle Hook	132	Walter	107
Cottle	118,121,122,128,130,132,134	Watson-Williams	125
Cottle-Neivert	132	Weil	136,143
Cottle-Walsham	133	Weil-Blakesley	143
Cutting Forcep	140	Schmeden	144,145
Cutting Giraffe	139		146
Cutting Pediatric	141		
Ferris-Smith-Kerrison	109		
Fomon Alar Hooklet	130		
Fomon	118,125,129,132		
Fraenkel	107		
Freer Mucosa Knife	119		
Freer Septum Gouge	123		
Freer	119,120,123,131		
Frontal Sinus	138		
Gallaher	128		
Giraffe Type	139		
Graig	113		
Gruenwald Nasal Forcep	136		
Grunwald (jansen)	117		
Hajek-Kofler	108		
Halle	120		
Hartmann	106,113,146		
Hartmann-Halle	106		
Joseph File	128		
Joseph Mucosa Hooklet	130		
Joseph Nasal Saws	127		
Joseph Osteotome	127		
Joseph	118,120,122,128,131		
Joseph-Masing	122		
Masing	122		
Mckenty	120,121		
Middleton-Jansen	115		
Nasal Cutting Cont	135		
Neivert	132		
Neivert-Anderson	126		
Ogura	134		
Ostrum Antrum Punch	137		
Parkes	127		
Pediatric Ostrum	137		
Pediatric Rotating	138		
Pennington	121		
Roger	122		

Nasal specula



SS-22-101
Fig. 1



SS-22-102
Fig. 2



SS-22-103
Fig. 3



SS-22-101 Fig. 1
SS-22-102 Fig. 2
SS-22-103 Fig. 3
14 cm
Vienna pattern



SS-22-104
Fig. 1



SS-22-105
Fig. 2



SS-22-104 Fig. 1
SS-22-105 Fig. 2
13 cm
Vienna pattern

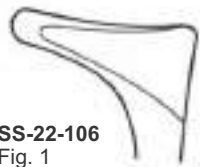

SS-22-106
Fig. 1



SS-22-107
Fig. 2

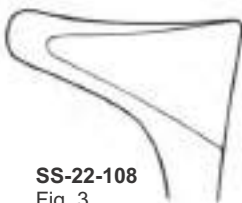

SS-22-108
Fig. 3



SS-22-106 Fig. 1
SS-22-107 Fig. 2
SS-22-108 Fig. 3
15 cm
Vienna pattern



SS-22-109
14 cm

Nasal specula



SS-22-110

SS-22-111

Tieck-Halle
SS-22-110 Fig. 1
SS-22-111 Fig. 2
13.5 cm

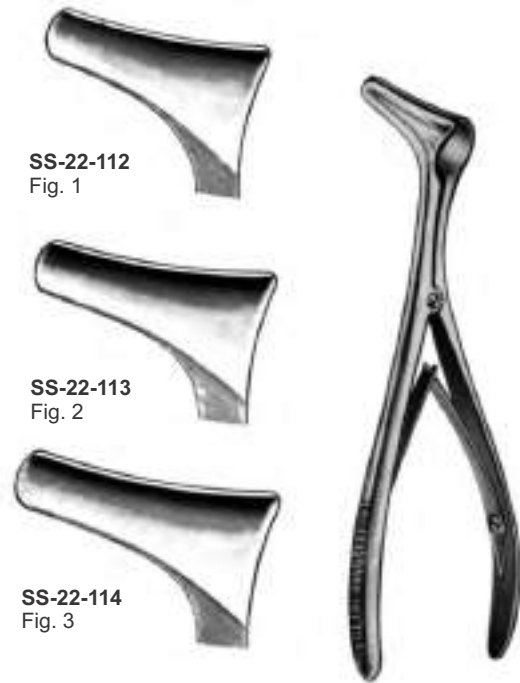

SS-22-112
Fig. 1

SS-22-113
Fig. 2

SS-22-114
Fig. 3

Aseptic joint
(dismantleable)

Hartmann
SS-22-112 Fig. 1
SS-22-113 Fig. 2
SS-22-114 Fig. 3
15 cm



Hartmann-Halle
SS-22-115 Fig. 1
SS-22-116 Fig. 2
SS-22-117 Fig. 3
15 cm

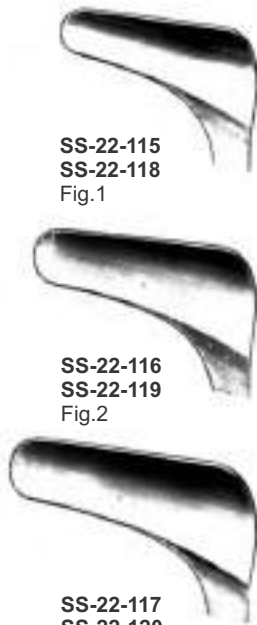

SS-22-115
SS-22-118
Fig.1

SS-22-116
SS-22-119
Fig.2

SS-22-117
SS-22-120
Fig.3



Hartmann-Halle
SS-22-118 Fig. 1
SS-22-119 Fig. 2
SS-22-120 Fig. 3
15 cm

Nasal specula

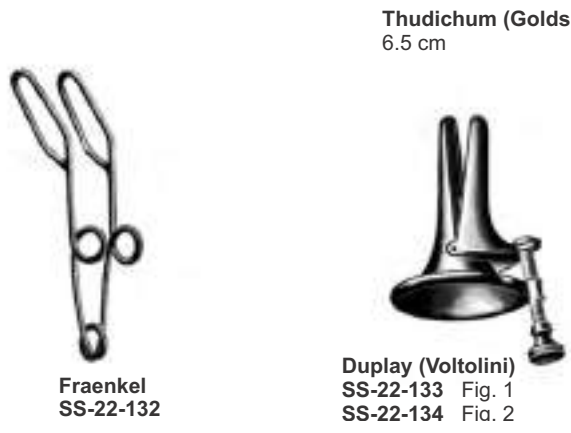
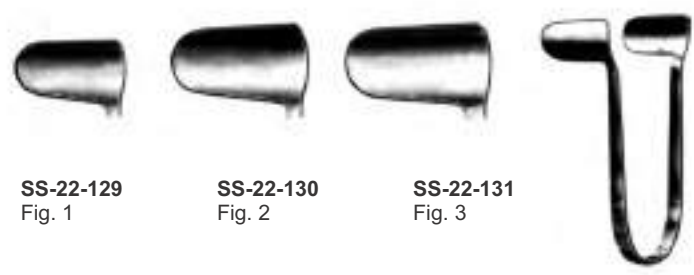
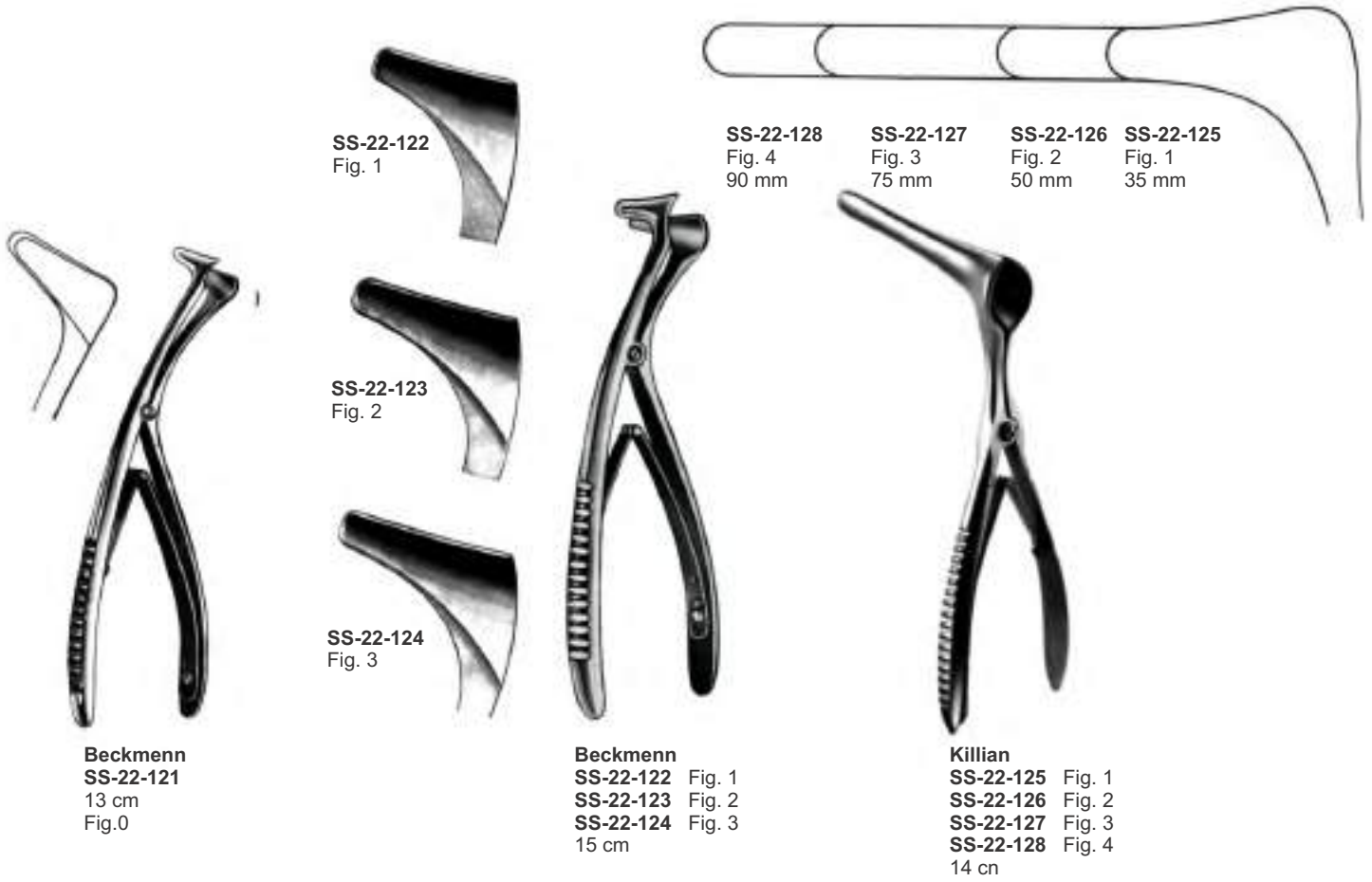

Sphenoid Bone Punches

4 x 4 mm

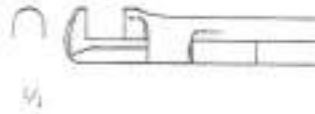

**Hajek
 SS-22-136**
 14 cm / 5 1/2"
 up cutting

4 x 4 mm

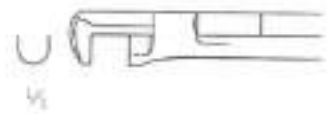

**Hajek
 SS-22-137**
 14 cm / 5 1/2"
 down cutting

3.5 x 3.5 mm

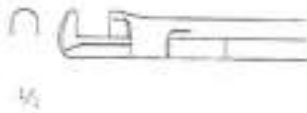

**Hajek-Kofler
 SS-22-138**
 14 cm / 5 1/2"
 up cutting

3.5 x 3.5 mm



**Hajek-Kofler
 SS-22-139**
 14 cm / 5 1/2"
 down cutting

140 mm



Sphenoid Bone Punches

3 x 3 mm

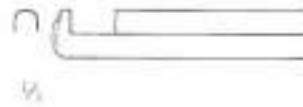

SS-22-140
18 cm / 7"
up cutting

3 x 3 mm

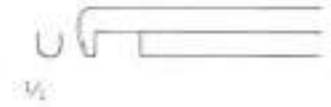

SS-22-141
18 cm / 7"
down cutting

180 mm



Ferris-Smith-Kerrison

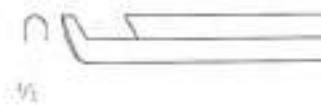

SS-22-142
18 cm / 7"
obliquely forward cutting
bite
3.0 mm

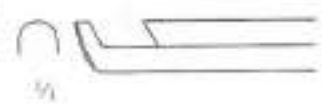

SS-22-143
18 cm / 7"
obliquely forward cutting
bite
5.0 mm

180 mm



Ferris-Smith-Kerrison

Antrum Punches

3 x 3 mm



SS-22-145
up cutting

4 x 4 mm



SS-22-146
up cutting

5 x 5 mm



SS-22-147
up cutting

6 x 6 mm



SS-22-148
up cutting

90 mm



Kerrison

Adenoid Curettes



Beckmenn
trapezoidal fenestrated



SS-22-149
22.5 cm / 8 ¾"
16 mm
Fig. 1



SS-22-150
22.5 cm / 8 ¾"
17 mm
Fig. 2



SS-22-151
22.5 cm / 8 ¾"
18 mm
Fig. 3



SS-22-152
22.5 cm / 8 ¾"
20 mm
Fig. 4



SS-22-153
22.5 cm / 8 ¾"
21 mm
Fig. 5

Adenoid Curettes



Beckmann



**Beckmann
angled shaft**



SS-22-154
22.5 cm / 8 ¾"
13 mm
Fig. 1



SS-22-155
22.5 cm / 8 ¾"
15 mm
Fig. 2



SS-22-156
22.5 cm / 8 ¾"
17 mm
Fig. 3

SS-22-160
22 cm / 8 ¾"
13 mm

SS-22-161
22 cm / 8 ¾"
15 mm

SS-22-162
22 cm / 8 ¾"
17 mm



SS-22-157
22.5 cm / 8 ¾"
19 mm
Fig. 4



SS-22-158
22.5 cm / 8 ¾"
21 mm
Fig. 5



SS-22-159
22.5 cm / 8 ¾"
23 mm
Fig. 6

SS-22-163
22 cm / 8 ¾"
19 mm

SS-22-164
22 cm / 8 ¾"
21 mm

SS-22-165
22 cm / 8 ¾"
23 mm

Nasal Polypus Forceps, Septum Forceps



Hartmann
SS-22-166
15 cm / 6"



Hartmann
SS-22-167
18.5 cm / 7 1/4"



Killian
SS-22-168
16 cm / 6 1/4"



Knight
SS-22-169
17 cm / 6 3/4"



Graig
SS-22-170
16 cm / 6 1/4"

Septum Forceps, Ethmoid Bone Forceps



SS-22-171
16 cm / 6 ¼"
left curved



SS-22-172
16 cm / 6 ¼"
right curved



Luc



SS-22-173
18.5 cm / 7 ¼"
Fig. 1



SS-22-174
18.5 cm / 7 ¼"
Fig. 2



Luc



SS-22-175
18.5 cm / 7 ¼"
Fig. 1



SS-22-176
18.5 cm / 7 ¼"
Fig. 2

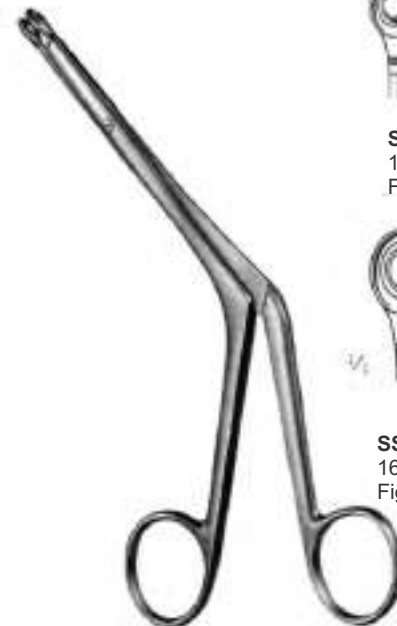

Brunings



SS-22-177
16.5 cm / 6 ½"
Fig. 1



SS-22-178
16.5 cm / 6 ½"
Fig. 2



SS-22-179
16.5 cm / 6 ½"
Fig. 3



SS-22-180
16.5 cm / 6 ½"
Fig. 4

Septum Forceps



Middleton-Jansen
SS-22-181
19 cm / 7 1/2"



Middleton-Jansen
SS-22-182
19 cm / 7 1/2"

Septum Forceps



Caplan
SS-22-183
20 cm / 8"
one toothed cutting edge



Rubin
SS-22-184
21 cm / 8 1/4"



TC-Rubin
SS-22-184A
21 cm / 8 1/2"

Nasal Tampon Forceps



Troltsch
SS-22-185
14.5 cm / 5 3/4"



Troltsch
SS-22-186
18 cm / 7"



Grunwald (Jansen)
SS-22-187
21.5 cm / 8 1/2"



Lubet-Barbon
SS-22-188
18.5 cm / 7 1/4"
Nasal Tampon Forceps

Rhinoplastic Knives



Joseph



SS-22-189
 15 cm / 6"
 Fig. 1



SS-22-190
 15 cm / 6"
 Fig. 2



Fomon



SS-22-191
 16.5 cm / 6 1/2"



Converse



SS-22-192
 16 cm / 6 1/4"



Joseph



SS-22-193
 15 cm / 6"



Cottle



SS-22-194
 14 cm / 5 1/2"

Septum Knives, Swivel Knives



SS-22-195
 16.5 cm / 6 1/2"

Freer
 Mucosa Knife



SS-22-196
 19 cm / 7 1/2"

Freer



SS-22-197
 19 cm / 7 1/2"

Freer



SS-22-198
 21 cm / 8 1/4"
 3.0 mm

Ballenger



SS-22-199
 21 cm / 8 1/4"
 4.0 mm



SS-22-200
 21 cm / 8 1/4"
 5.0 mm



SS-22-201
 20 cm / 8"
 3.0 mm

Ballenger



SS-22-202
 20 cm / 8"
 4.0 mm



SS-22-203
 20 cm / 8"
 5.0 mm

Septum Elevators



SS-22-204
16.5 cm / 6 1/2"

Brunings
Septum Knife



McKenty



SS-22-205
15 cm / 6"
4 mm



SS-22-206
15 cm / 6"
5 mm



Halle



SS-22-207
16 cm / 6 1/4"
3.5 mm



Jopseph



SS-22-208
16 cm / 6 1/4"
4 mm



Freer



SS-22-209
19 cm / 7 1/2"
5 mm
sharp



Freer



SS-22-210
19 cm / 7 1/2"
6 mm
blunt



Freer



SS-22-211
18.5 cm / 7 1/4"
5 / 5 mm
sharp / blunt



Freer



SS-22-212
20.5 cm / 8"
6 / 5 mm

Septum Elevators

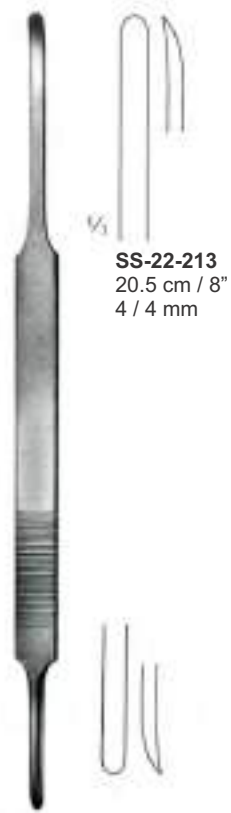

SS-22-213
 20.5 cm / 8"
 4 / 4 mm

McKenty



SS-22-214
 19 cm / 7 1/2"
 6 / 6 mm

Ballenger-Hajek



SS-22-215
 23.5 cm / 9 1/4"
 5 / 5 mm

Cottle



SS-22-216
 18 cm / 7"
 4 / 4 mm

Killian



SS-22-217
 23 cm / 9"
 4.5 / 4.5 mm

Killian

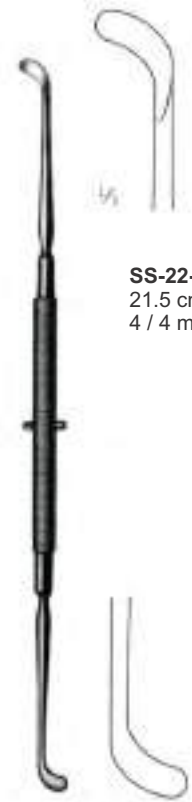

SS-22-218
 21.5 cm / 8 1/2"
 4 / 4 mm

Bannington



Osteotomes



SS-22-235
18.5 cm / 7 1/4"
4 mm



SS-22-236
18.5 cm / 7 1/4"
7 mm



SS-22-237
18.5 cm / 7 1/4"
9 mm



SS-22-238
18.5 cm / 7 1/4"
12 mm

Cottle



SS-22-239
18.5 cm / 7 1/4"
6 mm

Cottle



SS-22-240
18.5 cm / 7 1/4"
2 mm



SS-22-241
18.5 cm / 7 1/4"
4 mm



SS-22-242
18.5 cm / 7 1/4"
7 mm

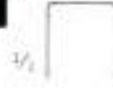

SS-22-243
18.5 cm / 7 1/4"
9 mm



SS-22-244
18.5 cm / 7 1/4"
12 mm

Cottle

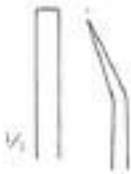

SS-22-245
18.5 cm / 7 1/4"
6 mm

Cottle

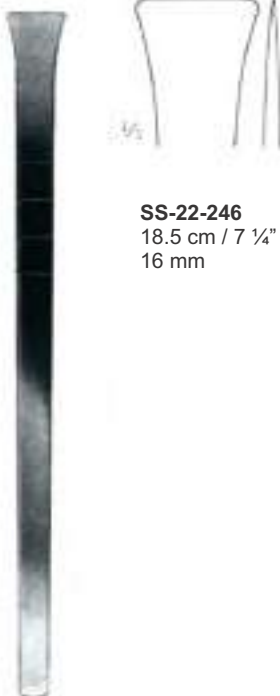

SS-22-246
18.5 cm / 7 1/4"
16 mm

Cottle

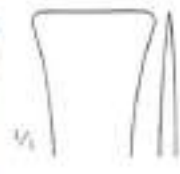

SS-22-247
18.5 cm / 7 1/4"
16 mm

Cottle

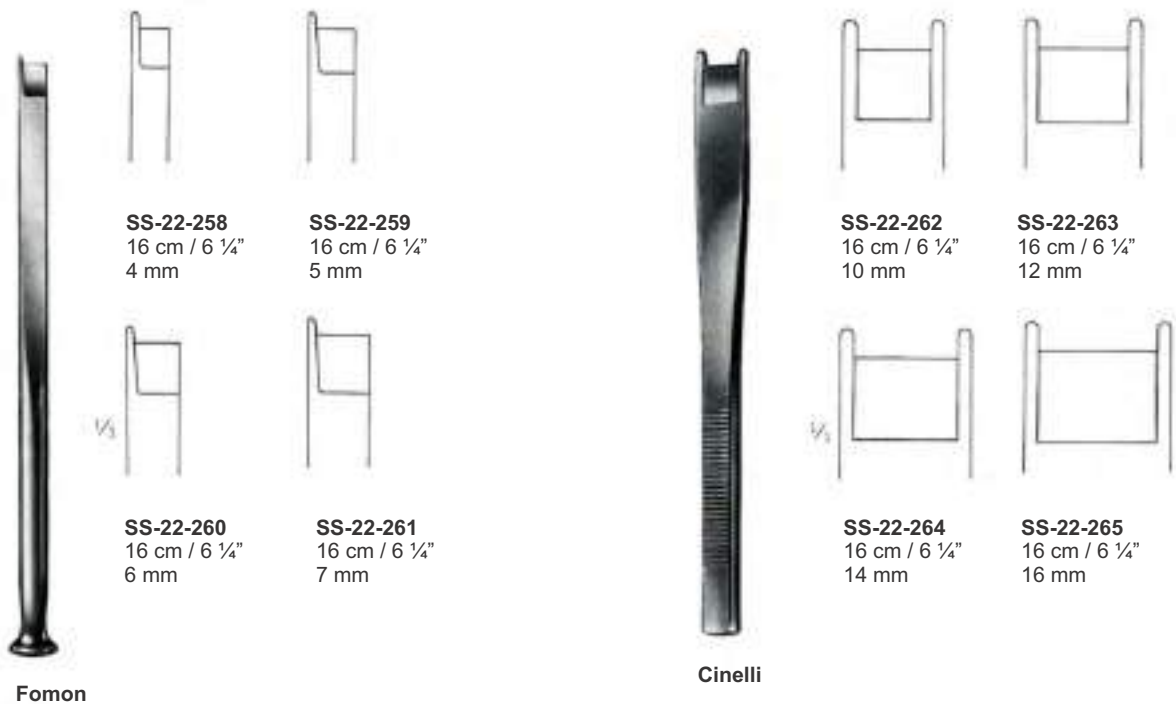
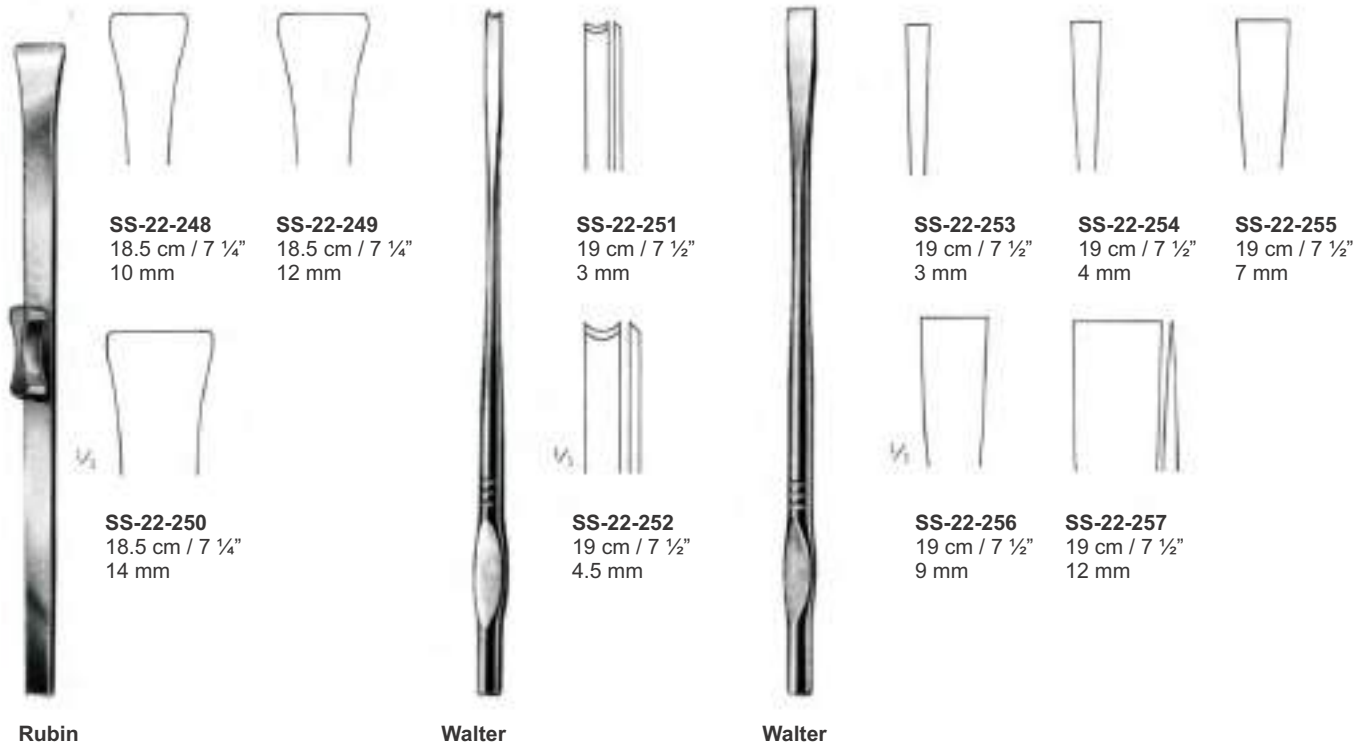

Osteotomes



Neivert-Anderson



SS-22-266
20.5 cm / 8"
7 mm

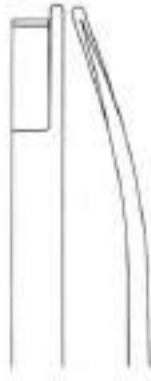

SS-22-267
20.5 cm / 8"
7 mm



SS-22-268
20.5 cm / 8"
7 mm



SS-22-269
15 cm / 6"
1 mm



SS-22-270
15 cm / 6"
2 mm



SS-22-271
15 cm / 6"
3 mm



SS-22-272
15 cm / 6"
4 mm



SS-22-273
15 cm / 6"
5 mm



Sheehan



SS-22-274
15 cm / 6"
6 mm



SS-22-275
15 cm / 6"
7 mm



SS-22-276
15 cm / 6"
8 mm



SS-22-277
15 cm / 6"
10 mm



SS-22-278
15 cm / 6"
12 mm



SS-22-279
18 cm / 7"
5 mm
straight

Silver

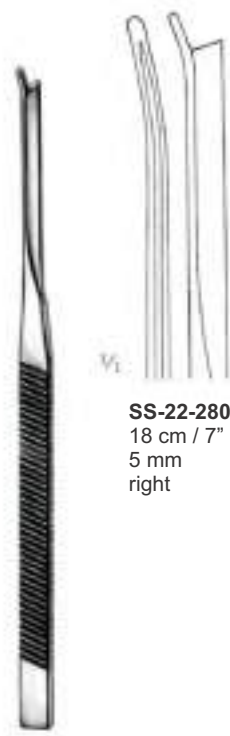

SS-22-280
18 cm / 7"
5 mm
right

Silver



SS-22-281
18 cm / 7"
5 mm
left

Silver



SS-22-282
16 cm / 6 1/4"

Parkes



SS-22-283
17 cm / 6 3/4"
angled to left

SS-22-284
17 cm / 6 3/4"
angled to right

Joseph



Joseph
working length 40 mm



SS-22-285
19 cm / 7 1/2"



SS-22-286
19 cm / 7 1/2"



SS-22-287
19 cm / 7 1/2"

Nasal Rasps, Bone Files, Antrum Rasps



Maltz

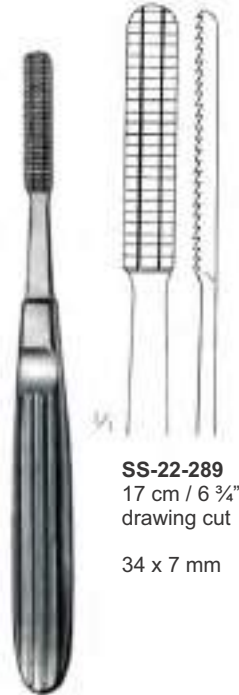

Maltz

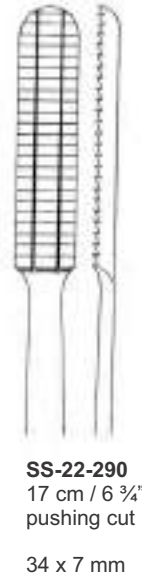

34 x 7 mm



Joseph



Joseph



Gallaher

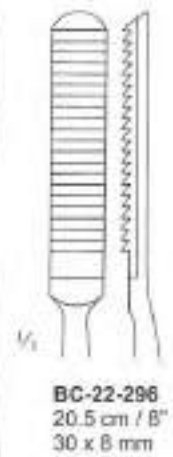

Cottle

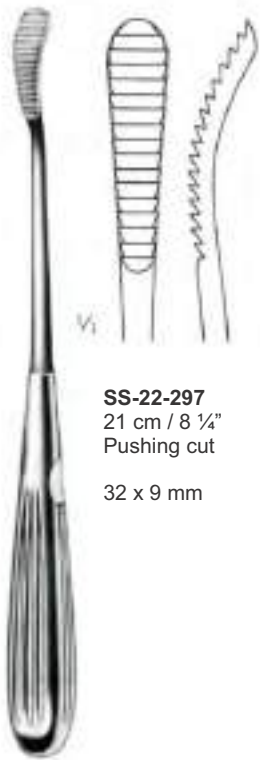

SS-22-297
21 cm / 8 ¼"
Pushing cut
32 x 9 mm

Aufricht

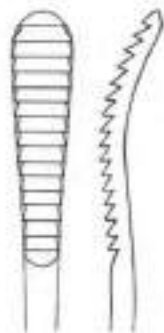

SS-22-298
21 cm / 8 ¼"
drawing cut
32 x 9 mm



Lewis

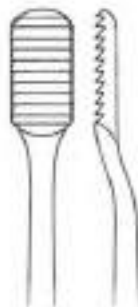

SS-22-299
19 cm / 7 ½"
drawing cut
15 x 8 mm



SS-22-300
19 cm / 7 ½"
drawing cut
15 x 8 mm



Fomon



SS-22-301
20.5 cm / 8"
30 x 8 mm

Nasal Hooks, Nasal Retractors



SS-22-302
15.5 cm / 6"
sharp

Joseph
Mucosa hooklet



SS-22-303
17 cm / 6 3/4"
sharp

Cottle



SS-22-304
14.5 cm / 5 3/4"
sharp

Cottle



SS-22-305
14.5 cm / 5 3/4"
sharp



SS-22-306
14.5 cm / 5 3/4"
sharp



SS-22-307
23 cm / 9"
button end

Lange
Alar Hooklet



SS-22-308
9 cm / 3 1/2"
18 x 9.5 mm

SS-22-310
9 cm / 3 1/2"
28 x 12.5 mm

Converse

SS-22-309
9 cm / 3 1/2"
41 x 13.5 mm

SS-22-311
9 cm / 3 1/2"
53 x 13.5 mm



SS-22-312
17 cm / 6 3/4"

Fomon
Alar Hooklet



SS-22-313
19 cm / 7 1/2"
blade
40 x 12 mm

Aufricht



SS-22-314
8 cm / 3 1/4"
sharp

Kilner
Alar Hooklet



Converse

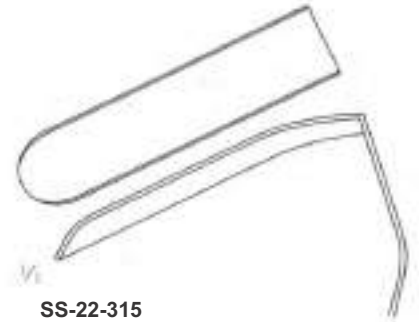

SS-22-315
10.5 cm / 4"
blade
44 x 11 mm



SS-22-316
11.5 cm / 4 1/2"
sharp



Converse
Alar Hooklet



SS-22-317
15 cm / 6"
sharp



Freer



SS-22-318
16.5 cm / 6 1/2"
2 mm



Joseph



SS-22-319
16.5 cm / 6 1/2"
5 mm



SS-22-320
16.5 cm / 6 1/2"
7 mm



SS-22-321
16.5 cm / 6 1/2"
10 mm

Alar Hooklets, Nasal Retractors

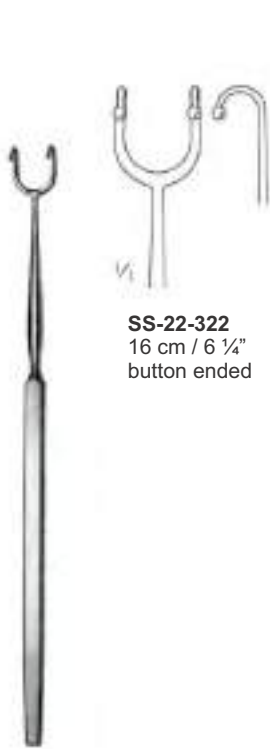

SS-22-322
16 cm / 6 1/4"
button ended

Fomon

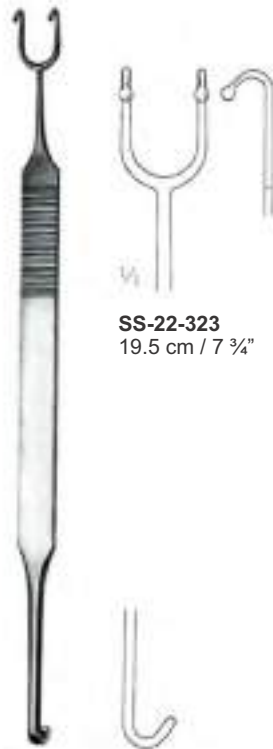

SS-22-323
19.5 cm / 7 3/4"

Cottle-Neivert



SS-22-324
14.5 cm / 5 3/4"
sharp

Cottle



SS-22-325
14.5 cm / 5 3/4"
blunt / sharp



SS-22-326
14.5 cm / 5 3/4"
sharp / blunt



SS-22-327
14 cm / 5 1/2"

Cottle

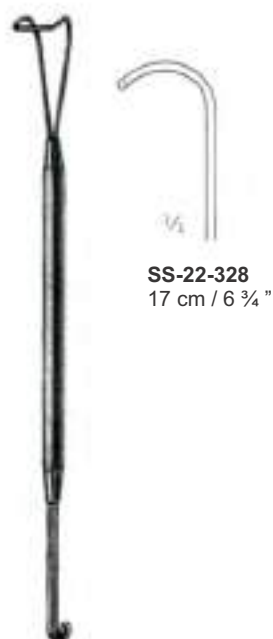

SS-22-328
17 cm / 6 3/4"

Neivert



SS-22-329
14 cm / 5 1/2"

Cottle
Saddle Hook



SS-22-330
16 cm / 6 1/4"

Cottle

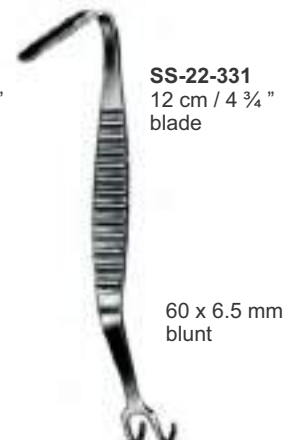

SS-22-331
12 cm / 4 3/4"
blade

Aufricht

60 x 6.5 mm
blunt

Septum Forceps, Septum Straightening Forceps



SS-22-333
23 cm / 9"
straight

SS-22-334
23 cm / 9"
left

SS-22-335
23 cm / 9"
right



SS-22-336
22.5 cm / 8 3/4"



SS-22-332
21 cm / 8 1/4"

Kressner



Cottla-Walsham



Asch

Skin Grasping Forceps



SS-22-337
 15.5 cm / 6"
 5 mm wide

Aiach
 Columella Suturing Forceps

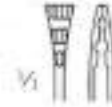

SS-22-338
 11 cm / 4 1/4"
 4 mm wide



Ogura



SS-22-339
 14 cm / 5 1/2"
 1.7 mm wide
 with teeth

Cottle

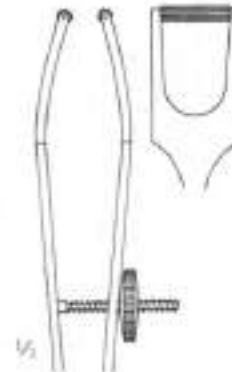

SS-22-340
 11 cm / 4 1/4"
 12 mm wide



Cottle
 Columella Forceps



Punch

SS-22-341
Curved right
SS-22-342
Curved left



Scissors

SS-22-343
straight

SS-22-244
Scissors
curved down

SS-22-345
Scissors
Curved right

SS-22-346
scissors
Curved left



Nasal Cutting

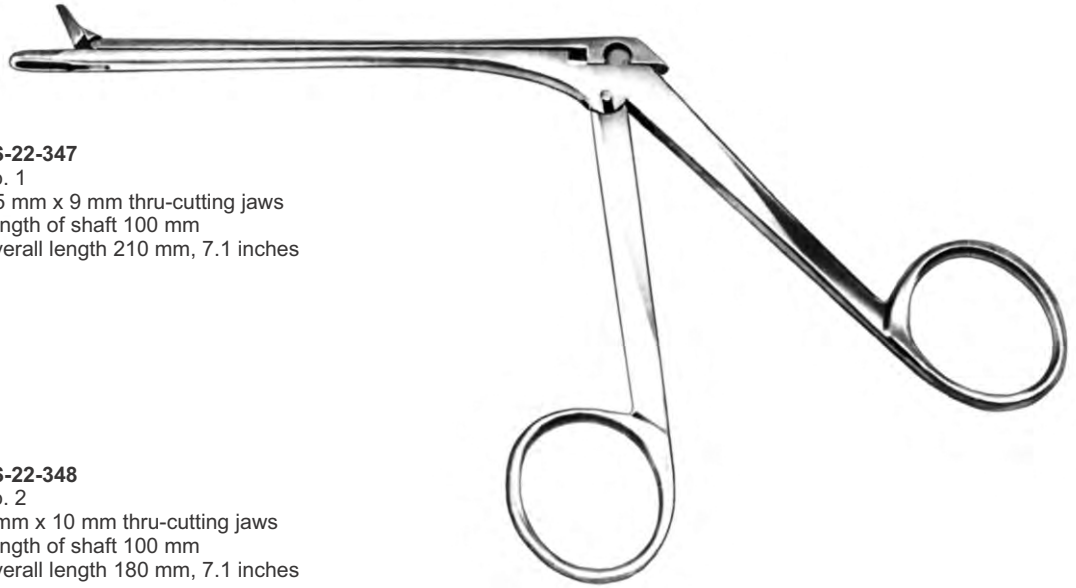

SS-22-347
No. 1
2.5 mm x 9 mm thru-cutting jaws
Length of shaft 100 mm
Overall length 210 mm, 7.1 inches

Gruenwald Nasal Forceps



SS-22-348
No. 2
3 mm x 10 mm thru-cutting jaws
Length of shaft 100 mm
Overall length 180 mm, 7.1 inches

Gruenwald Nasal Forceps



SS-22-349
No. 3
3.5 mm x 11 mm thru-cutting jaws
Length of shaft 100 mm
Overall length 180 mm, 7.1 inches

Gruenwald Nasal Forceps



SS-22-352
5 mm x 8 mm cups
Length of shaft 100 mm
Overall length 182 mm, 7.2 inches

Weil Nasal Forceps



SS-22-350
Straight
3.5 mm x 10 mm thru-cutting jaws
Length of shaft 100 mm
Overall length 180 mm, 7.1 inches

Gruenwald Nasal Forceps



SS-22-353
5 mm x 8 mm cups
Length of shaft 100 mm
Overall length 182 mm, 7.1 inches

Weil Nasal Forceps



SS-22-351
3 mm x 5 mm thru-cutting jaws with basket upturned
Length of shaft 125 mm
Overall length 205 mm, 8.1 inches

Watson-Williams Nasal Forceps



SS-22-354
5 mm x 10 mm cups, fenestrated
Length of shaft 100 mm
Overall length 182 mm, 7.1 inches

Wilde Nasal Forceps



SS-22-355
Straight, backward cutting left side
3 mm x 7 mm bite
Length of shaft 100 mm
Overall length 180 mm, 7.1 inches

**Ostrum Antrum
Punch Forceps**



**Ostrum Antrum
Punch Forceps**



SS-22-356
Straight, backward cutting right side
3 mm x 7 mm bite
Length of shaft 100 mm
Overall length 180 mm, 7.1 inches



SS-22-357
Left side cutting

**Sidebiting Antrum
Punch Forceps**



SS-22-358
Right side cutting

**Sidebiting Antrum
Punch Forceps**



SS-22-359
Straight, backward cutting
1.5 mm x 4 mm bite
Length of shaft 115 mm
Overall length 160 mm, 6.3 inches

**Pediatric Ostrum
Antrum Punch
Forceps**



SS-22-360
Straight, right side cutting
1.5 mm x 4 mm bite
Length of shaft 115 mm
Overall length 160 mm, 6.3 inches

**Pediatric Ostrum
Antrum Punch
Forceps**



**Pediatric Ostrum
Antrum Punch
Forceps**



SS-22-361
Straight, left side cutting
1.5 mm x 4 mm bite
Length of shaft 115 mm
Overall length 160 mm, 6.3 inches

Nasal Cutting



SS-22-362
Rotating 360°
**Rotating ostrum
Antrum punch
Forceps**



3 mm x 7 mm bite



SS-22-363
Rotating 360°
**Pediatric Rotating ostrum
Antrum punch
Forceps**



1.5 mm x 4 mm bite

Nasal and Sinus Cutting



**Front sinus
Forceps**

SS-22-364
450° vertical cutting
2 mm cups
Length of shaft 140 mm
Overall length 225 mm, 8.9 inches



**Front sinus
Forceps**

SS-22-367
90° horizontal cutting
2 mm cups
Length of shaft 140 mm
Overall length 225 mm, 8.9 inches



**Front sinus
Forceps**

SS-22-365
450° horizontal cutting
2 mm cups
Length of shaft 140 mm
Overall length 225 mm, 8.9 inches



**Front sinus
Forceps**

SS-22-368
45° vertical cutting
3 mm cups
Length of shaft 140 mm
Overall length 225 mm, 8.9 inches



**Front sinus
Forceps**

SS-22-366
90° vertical cutting
2 mm cups
Length of shaft 140 mm
Overall length 225 mm, 8.9 inches



**Front sinus
Forceps**

SS-22-369
90° horizontal cutting
3 mm cups
Length of shaft 140 mm
Overall length 225 mm, 8.9 inches





SS-22-370
70° vertical cutting, double action
3 mm cups
length of shaft 130 mm
Overall length 210 mm, 8.3 inches

**Giraffe Type
Sinus Forceps**



SS-22-371
70° horizontal cutting, double action
4 mm cups
length of shaft 130 mm
Overall length 210 mm, 8.3 inches

**Giraffe Type
Sinus Forceps**



SS-22-372
100° horizontal cutting
4 mm cups
length of shaft 130 mm
Overall length 210 mm, 8.3 inches

**Giraffe Type
Sinus Forceps**

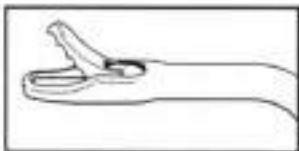
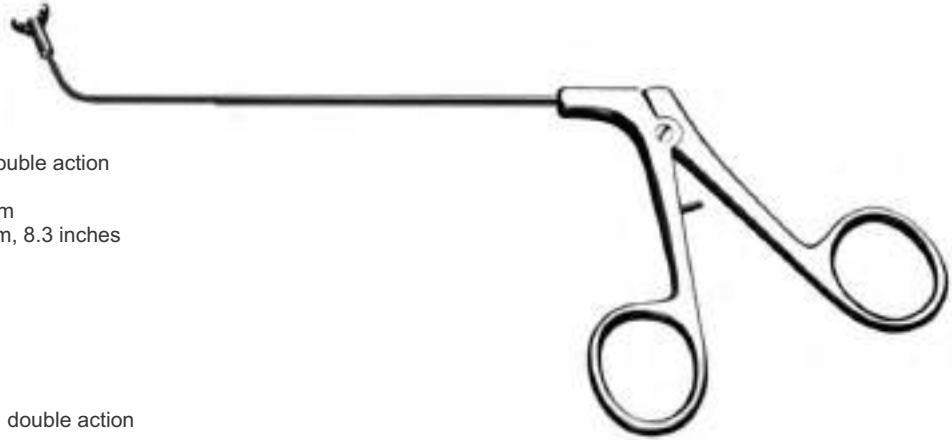

SS-22-373
70° horizontal cutting
1.6 mm x 80 mm bite

**Cutting Giraffe
Forceps**

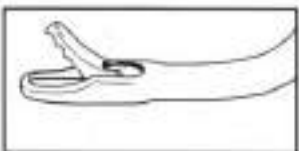

SS-22-374
70° vertical cutting
1.6 mm x 80 mm bite

**Cutting Giraffe
Forceps**

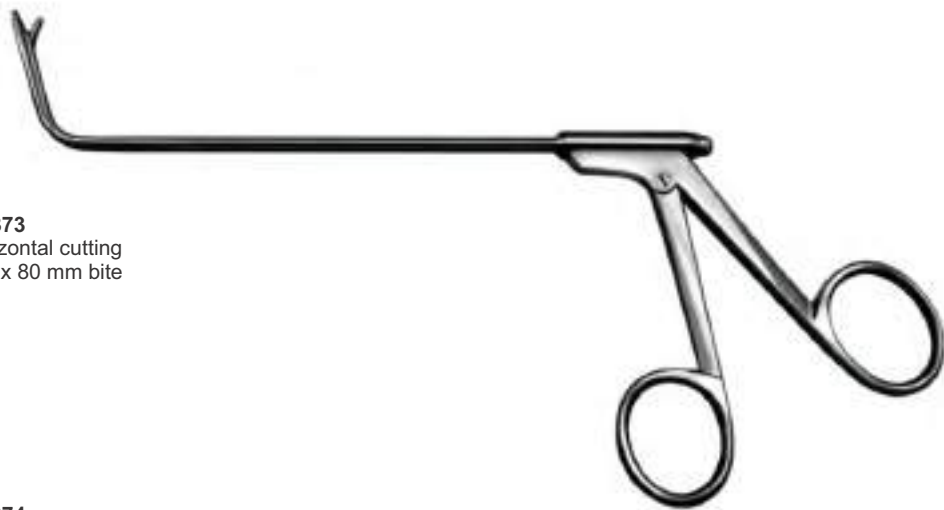

Nasal & Sinus Cutting



SS-22-375
70° vertical cutting
3 mm x 6 mm bite
Working length 120 mm, 4.7 inches

**Thru Cutting
Giraffe Forceps**



SS-22-376
No.1
straight
3.5 mm x 10 mm bite
Working length 120 mm, 4.7 inches

**Thru Cutting
Giraffe Forceps**



SS-22-377
No.1
45° angled up
2.5 mm x 10.5 mm jaw
Working length 220 mm, 8.9 inches

Cutting Forceps

SS-22-378
Cutting Forceps
No.0
straight
2.3 mm x 10 mm jaw
Working length 220 mm, 8.9 inches



SS-22-379
No.1
straight
2.5 mm x 10.5 mm jaw
Working length 220 mm, 8.9 inches

Cutting Forceps

SS-22-380
Cutting Forceps
No.0
45° angled up
2.3 mm x 10 mm jaw
Working length 220 mm, 8.9 inches





SS-22-381
Straight
3 mm x 10 mm bite
Working length 120 mm, 4.7 inches

TC
Thru Cutting
Pediatric Forceps

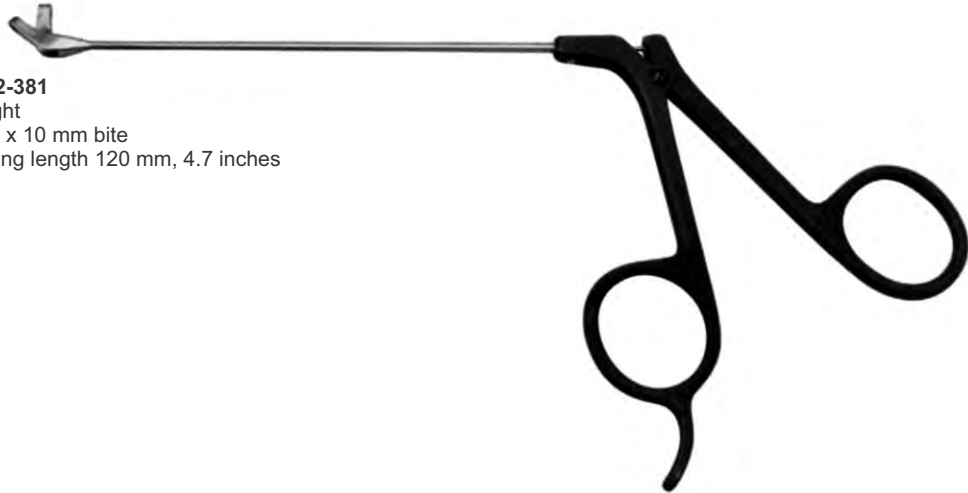

SS-22-382
45° angled up
2 mm x 6 mm bite
Working length 220 mm, 8.9 inches

Cutting
Pediatric Forceps



SS-22-382
Straight
2 mm x 6 mm bite
Working length 220 mm, 8.9 inches

Cutting
Pediatric Forceps

Polypus Snares



Krause

SS-22-384
26 cm / 10 1/4"
shaft
3 mm ø



Krause-Voss

SS-22-385
26 cm / 10 1/4"
shaft
3 mm ø

Ethmoid Bone Forceps

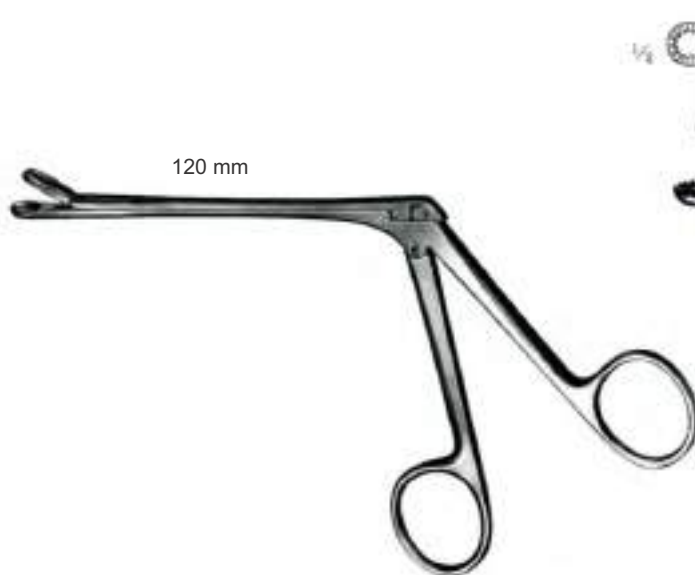

Watson-Williams
SS-22-402
19 cm / 7 1/2"

SS-22-403
19 cm / 7 1/2"

Weil
SS-22-404
12 cm / 4 3/4"
with neck

Nasal Cutting Forceps, Ethmoid Bone Forceps



SS-22-405
12 cm / 4 3/4"
Fig. 1
jaw width
3.0 mm



SS-22-406
12 cm / 4 3/4"
Fig. 2
jaw width
3.5 mm



SS-22-407
12 cm / 4 3/4"
Fig. 3
jaw width
4.5 mm



SS-22-408
12 cm / 4 3/4"
Fig. 4
jaw width
5.0 mm



SS-22-409
12 cm / 4 3/4"
Fig. 5
jaw width
5.5 mm

120 mm



Weil-Blakesley

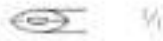

SS-22-410
12 cm / 4 3/4"
Fig. 1
jaw width
3.0 mm



SS-22-411
12 cm / 4 3/4"
Fig. 2
jaw width
3.5 mm



SS-22-412
12 cm / 4 3/4"
Fig. 3
jaw width
4.5 mm



SS-22-413
12 cm / 4 3/4"
Fig. 4
jaw width
5.0 mm

120 mm



Weil-Blakesley

Ethmoid Bone Forceps, Nasal Cutting Forceps



90°



SS-22-414
12 cm / 4 3/4"
Fig. 1
jaw width
3.0 mm



SS-22-415
12 cm / 4 3/4"
Fig. 2
jaw width
3.5 mm



SS-22-416
12 cm / 4 3/4"
Fig. 3
jaw width
4.5 mm



SS-22-417
12 cm / 4 3/4"
Fig. 4
jaw width
5.0 mm



120 mm

Weil-Blakesley



120 mm



SS-22-418
19 cm / 4 3/4"
Fig. 1
0.9 mm



SS-22-419
19 cm / 4 3/4"
Fig. 2
1.2 mm



Struycken

Nasal Cutting Forceps

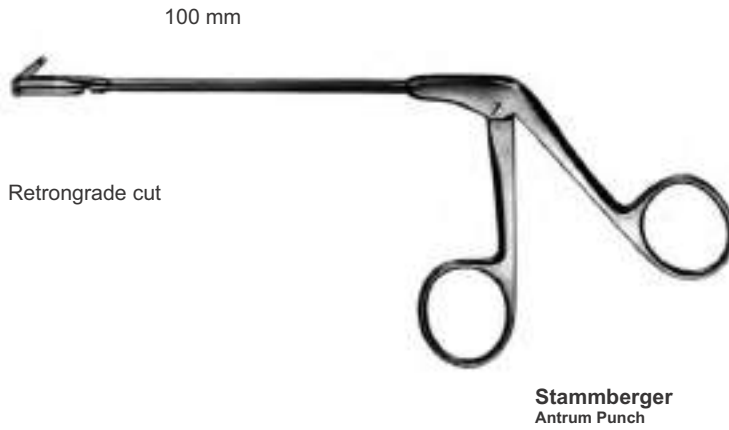

SS-22-420
2 mm
up cutting

SS-22-421
2 mm
right cutting

SS-22-422
2 mm
left cutting



SS-22-423
19 cm / 7 1/2"
5 mm ø



SS-22-424
19 cm / 7 1/2"
7 mm ø



SS-22-425
19 cm / 7 1/2"
9 mm ø



SS-22-426
19 cm / 7 1/2"
11 mm ø



Schmeden
SS-22-427
19 cm / 7 1/2"
jaw width

8.0 mm ø



Tonsil 23

23 Tonsil

Adson	159
Blohmke	152
Bruenings (tube)	155
Bruenings (tube, Curved)	155
Bruenings	153,156
Carpenter	149
Chevalier-jackson	162
Cordes	156
Cottle-joseph Double Hook	157
Eves	153
Fraenkel	156
Frazier (fergusson)	160
Frazier	159,160
Hartmann	154
Henke	150
Huber	155
Hurd	149,150
King Adenold Punch Forcep	154
Krause	156
Krishaber	162
Lange	156
Laryngeal Mirrors, Handles	163
Luer	162
Luniatschek	151
Millard Double Hook Forcep	157
Millard Double Hook	157
Rosenberg	156
Scheinmann	156
Schmidt	152
Schumacher	156
Seiffert	156
Komplett Mit 3 Aufsätzen	158
Tyding	153
White	152
Nuboer	164
Coupland	164
Yankauer	165,167
Cooly	166
Andrew-pynchon	167
Byrd	167
Cogswell	167
Poole	167

Cleft Palate Needles



Hurd



Hurd



Carpenter
Tonsil Knife / Enucleator

Tonsil Dissector, Elevators



SS-23-104
 22.5 cm / 8 ¾"
 11.0 & 14.0 mm

Hurd



Henke



SS-23-105
 22.5 cm / 8 ¾"
 10.5 & 5.0 mm



SS-23-106
 22.5 cm / 8 ¾"
 16.0 & 5.0 mm



Henke

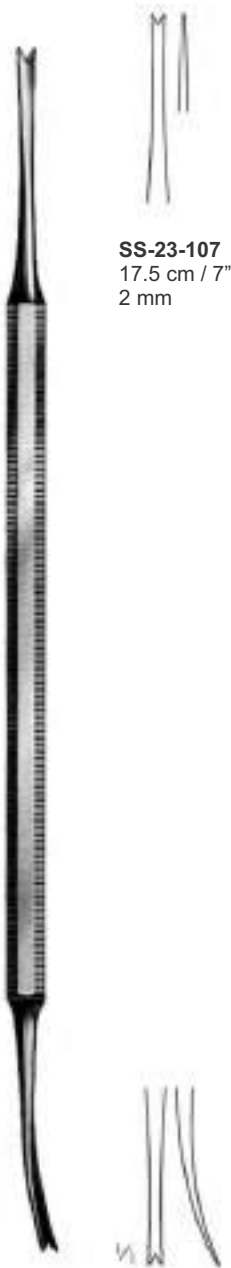

SS-23-107
17.5 cm / 7"
2 mm

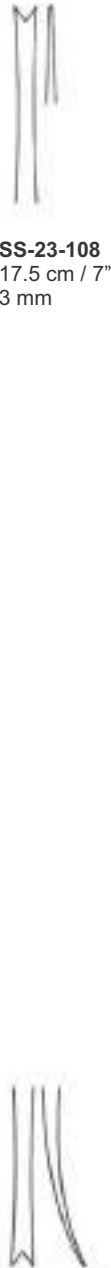

SS-23-108
17.5 cm / 7"
3 mm



SS-23-109
17.5 cm / 7"
2 mm

round handle

Luniatschek

Luniatschek

Tonsil Grasping Forceps

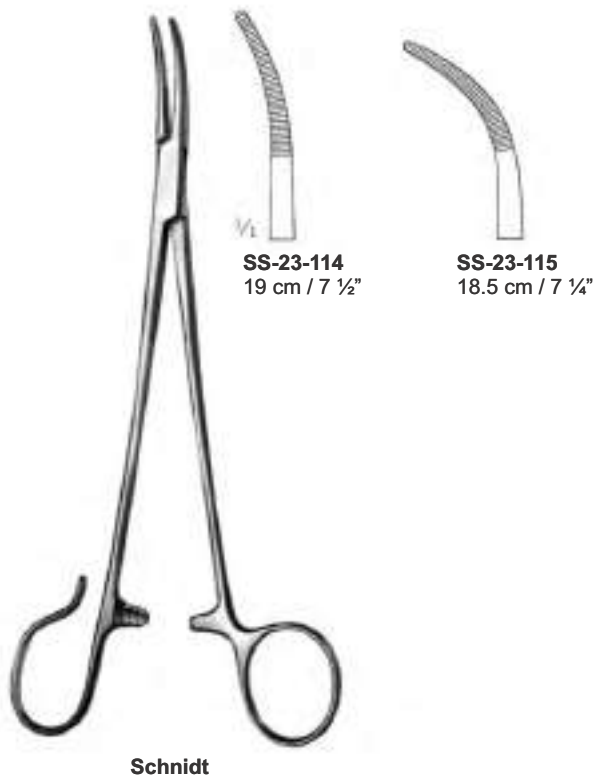
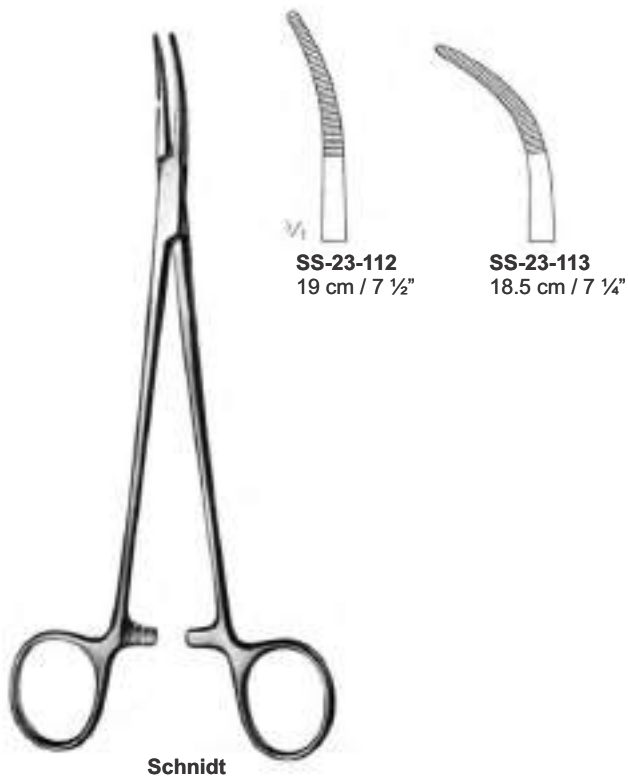
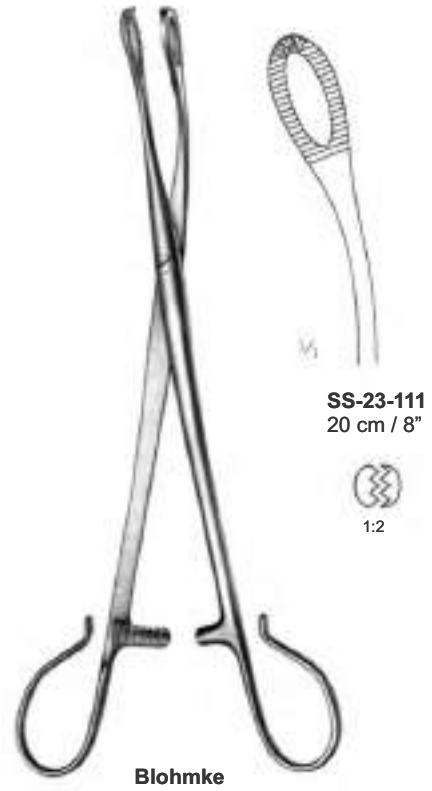
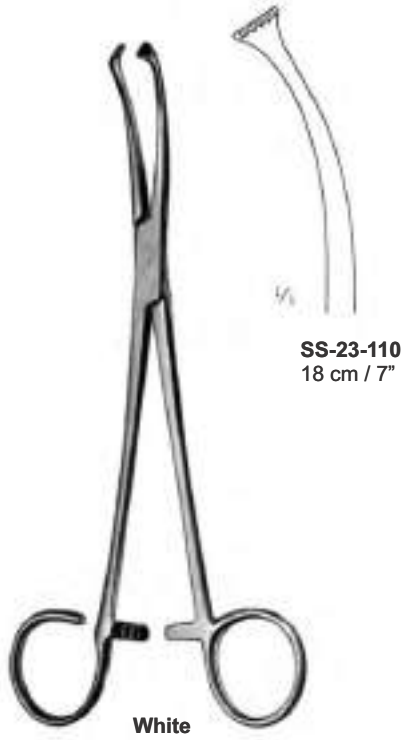

Tonsil Snares

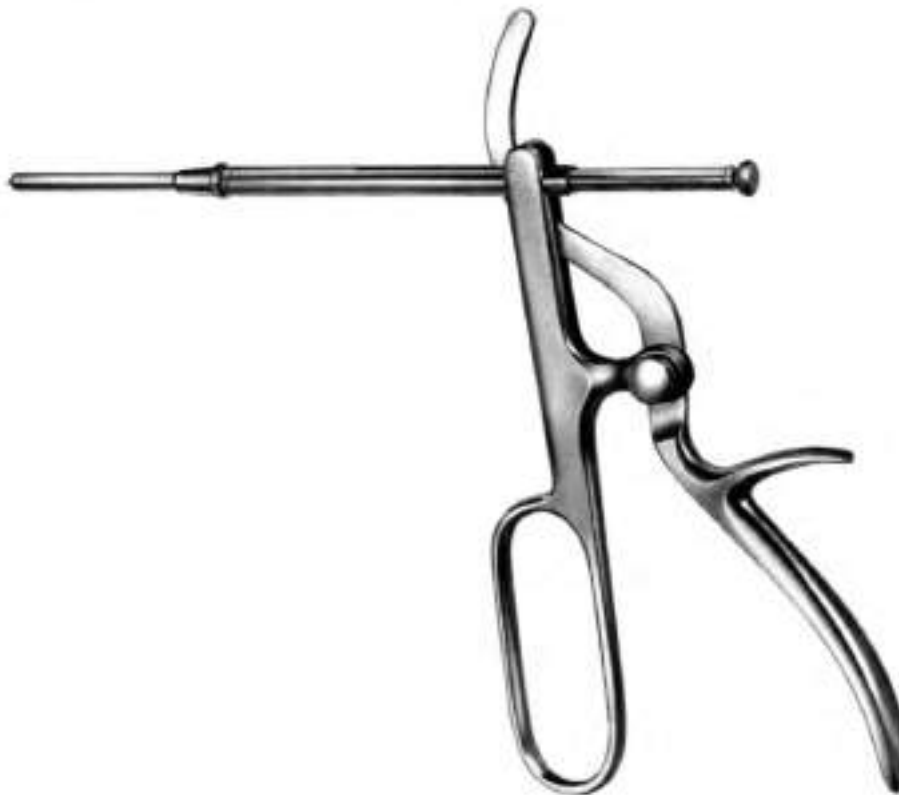
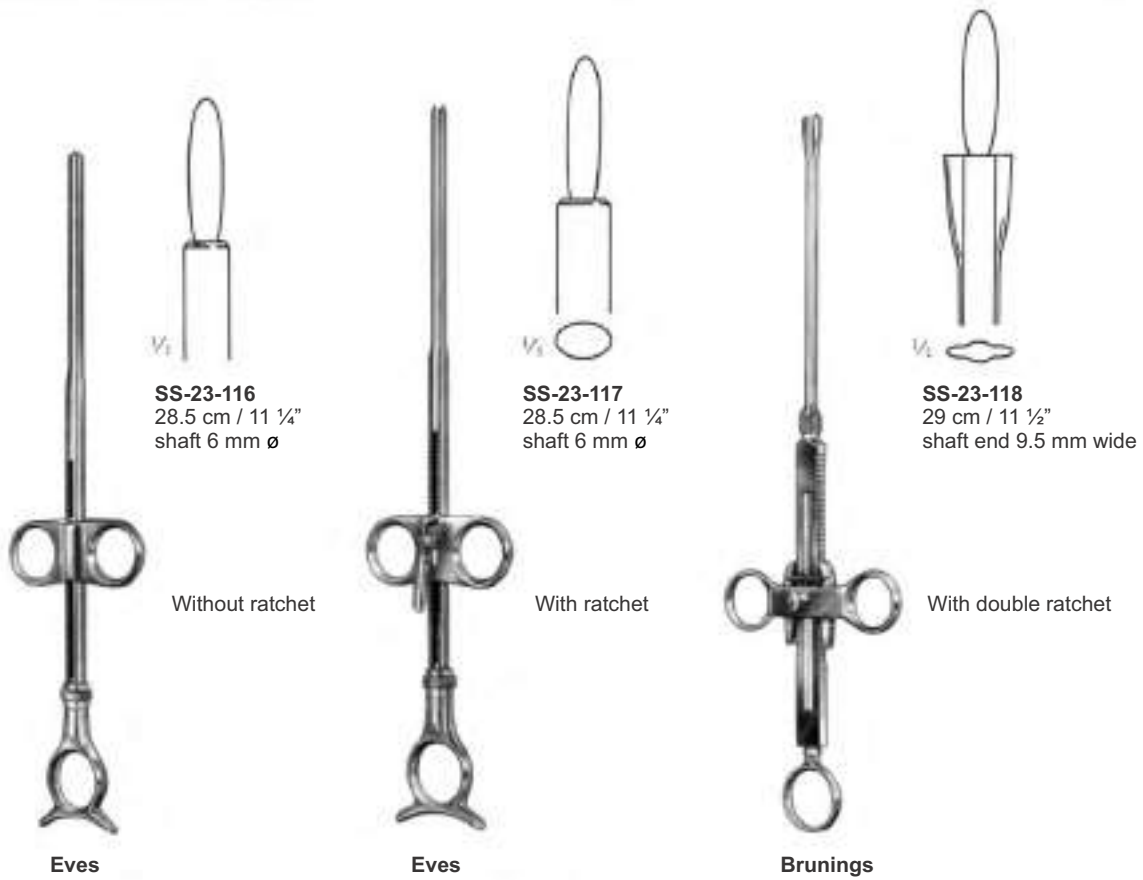

Tyding
SS-23-119
with one straight tip

Tonsil Punches



120 mm



SS-23-120
 12 cm / 4 3/4"
 cut
 13 mm \emptyset
 through cutting



SS-23-121
 12 cm / 4 3/4"
 cut
 15 mm \emptyset
 through cutting

Hartmann

Tonsil and Adenoid



SS-23-122
 No.1
 Triangular
 7 mm lower basket, 6 mm upper jaw
 strong curve
 45 mm from curve to tip
 length of shaft 110 mm
 Overall length 179 mm, 7.0 inches



King Adenoid
 Punch Forceps



Huber
SS-23-123
Universal handle
for interchangeable tubes ref.



Bruening
Interchangeable tube for handle ref.
SS-23-124 20 cm / 8"
SS-23-125 30 cm / 12"
SS-23-126 40 cm / 16"

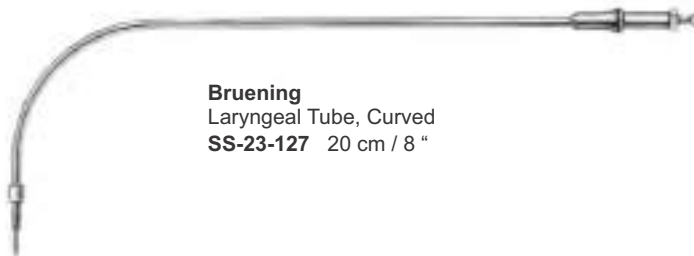

Bruening
Laryngeal Tube, Curved
SS-23-127 20 cm / 8 "

Exchangeable Tips

 B-23-128



Fraenkel

 SS-23-129



Seiffert

 SS-23-130



Fraenkel

 SS-23-131



Scheinmann

 SS-23-132



Scheinmann

 SS-23-133

 SS-23-134



Bruenings

 SS-23-135

 SS-23-136



Bruenings

 SS-23-137



Lange

 SS-23-138

 SS-23-139



Krause

 SS-23-140



Krause

 BC-23-141

 BC-23-142

 SS-23-143

 BC-23-144



Cordes

 SS-23-145



Schumacher

 SS-23-146

 SS-23-147



Cordes

 SS-23-148



Cordes

 SS-23-149



Rosenberg



Overall length 137mm, 5.4 inches

**Cottle-Joseph
Double Hook
SS-23-150**
12 mm wide



Millard Double
Hook Forceps

SS-23-151
with swivel thimble
1 x 2 teeth



10 mm wide double hook overall length
101 mm, 4.0 inches

**Millard
Double Hook
SS-23-153**
10 mm wide double hook thimble



Short flat handles
Overall length 84mm, 3.3 inches

Tonsillectomes

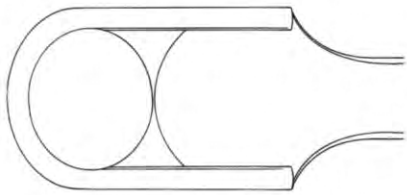

SS-23-154
Fig. 1

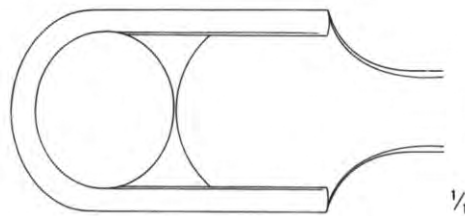

SS-23-155
Fig. 2

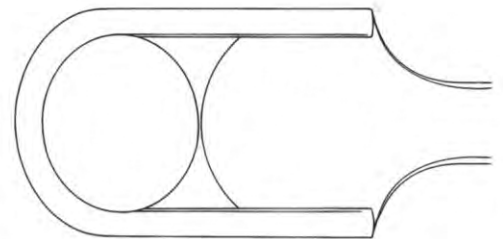

SS-23-156
Fig. 3

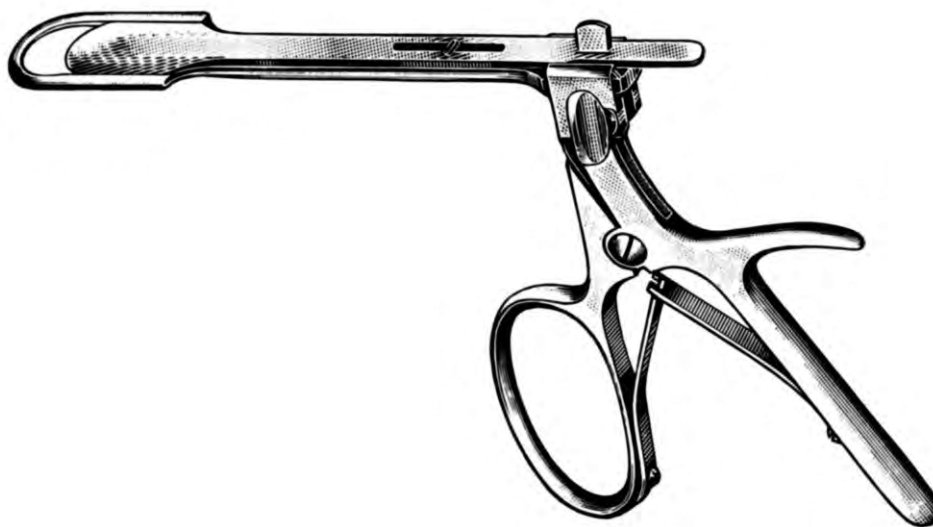

Komplett mit a aufsatzen

Suction Tubes



Adson
B-23-157
ø 4 mm, Charr.12



Adson
B-23-158
ø 4 mm, Charr.12



Adson
B-23-159
ø 4 mm, Charr.12



Frazier
SS-23-160 Charr. 8
SS-23-161 Charr. 10
SS-23-162 Charr. 12
12.5 cm



Frazier
SS-23-163 Charr. 8
SS-23-164 Charr. 10
SS-23-165 Charr. 12
12.5 cm

Suction Tubes



Frazier
SS-23-166 Charr. 6
SS-23-167 Charr. 8
SS-23-168 Charr. 10
SS-23-169 Charr. 12
 12.5 cm



Frazier (Fergusson)
SS-23-170 Charr. 6
SS-23-171 Charr. 8
SS-23-172 Charr. 10
SS-23-173 Charr. 12
 12.5 cm













Frazier
SS-23-174 Charr. 6
SS-23-175 Charr. 8
SS-23-176 Charr. 10
SS-23-177 Charr. 12
 18 cm



Frazier (Fergusson)
SS-23-178 Charr. 6
SS-23-179 Charr. 8
SS-23-180 Charr. 10
SS-23-181 Charr. 12
 18 cm

International scale of Trachea Tube Sizes

										
Size	0	1	2	3	4	5	6	7	8	9
ø mm	4	5	6	7	8	9	10	11	12	13
French	12	15	18	21	24	27	30	33	36	39
Length mm	45	50	55	60	65	70	75	80	85	90



Luer
Trachea Tube,
standard pattern

Nickel silver		Sterling silver
SS-23-182	Size 0-- ø 4 mm	SS-23-192
SS-23-183	Size 1-- ø 5 mm	SS-23-193
SS-23-184	Size 2-- ø 6 mm	SS-23-194
SS-23-185	Size 3-- ø 7 mm	SS-23-195
SS-23-186	Size 4-- ø 8 mm	SS-23-196
SS-23-187	Size 5-- ø 9 mm	SS-23-197
SS-23-188	Size 6-- ø 10 mm	SS-23-198
SS-23-189	Size 7-- ø 11 mm	SS-23-199
SS-23-190	Size 8-- ø 12 mm	SS-23-200
SS-23-191	Size 9-- ø 13 mm	SS-23-201



Luer
Trachea Tube,
with opening in inner
and outer tube

Nickel silver	
SS-23-202	Size 0-- ø 4 mm
SS-23-203	Size 1-- ø 5 mm
SS-23-204	Size 2-- ø 6 mm
SS-23-205	Size 3-- ø 7 mm
SS-23-206	Size 4-- ø 8 mm
SS-23-207	Size 5-- ø 9 mm
SS-23-208	Size 6-- ø 10 mm
SS-23-209	Size 7-- ø 11 mm
SS-23-210	Size 8-- ø 12 mm
SS-23-211	Size 9-- ø 13 mm

Trachea Tubes



Krishaber
Trachea Tube,
obturator has 4 fenestrations

Nickel --silver

SS-23-212	Size 0--	ø 4 mm
SS-23-213	Size 1--	ø 5 mm
SS-23-214	Size 2--	ø 6 mm
SS-23-215	Size 3--	ø 7 mm
SS-23-216	Size 4--	ø 8 mm
SS-23-217	Size 5--	ø 9 mm
SS-23-218	Size 6--	ø 10 mm
SS-23-219	Size 7--	ø 11 mm
SS-23-220	Size 8--	ø 12 mm



Chevalier-Jackson
Trachea Tube,
Nickel silver

SS-23-221	Size 0--	ø 4 mm
SS-23-222	Size 1--	ø 5 mm
SS-23-223	Size 2--	ø 6 mm
SS-23-224	Size 3--	ø 7 mm
SS-23-225	Size 4--	ø 8 mm
SS-23-226	Size 5--	ø 9 mm
SS-23-227	Size 6--	ø 10 mm
SS-23-228	Size 7--	ø 11 mm
SS-23-229	Size 8--	ø 12 mm
SS-23-230	Size 9--	ø 13 mm

Sterling silver

SS-23-231
SS-23-232
SS-23-333
SS-23-234
SS-23-235
SS-23-236
SS-23-237
SS-23-238
SS-23-239
SS-23-340



Luer
Speaking Tube,
inner tube with sliding valve
Nickel silver

SS-23-241	Size 4--	ø 8 mm
SS-23-242	Size 5--	ø 9 mm
SS-23-243	Size 6--	ø 10 mm
SS-23-244	Size 7--	ø 11 mm

Laryngeal Mirrors, Handles



SS-23-245
18.5 cm / 7 1/4"
Plane, with fixes handle



SS-23-247
13.5 cm / 5 1/4"
Plane, without handle

SS-23-246
18.5 cm / 7 1/4"
rhodium plated

SS-23-248
13.5 cm / 5 1/4"
rhodium plated



SS-23-249
Fig. 1
12 mmø



SS-23-250
Fig. 2
14 mmø



SS-23-251
Fig. 3
16 mmø



SS-23-252
Fig. 4
18 mmø



SS-23-253
10 cm / 4"



SS-23-254
10 cm / 4"



SS-23-255
12.5 cm / 5"

Michel
25 cm / 10"
moveable mirror



Nuboer
SS-23-256
21 cm / 8 1/4"
6 mm \varnothing
round opening



Nuboer
SS-23-257
21 cm / 8 1/4"
6 mm \varnothing
oval opening



SS-23-259
tip laterally
perforated



Coupland
SS-23-258
17 cm / 6 3/4"
Suction Handle with tube connector



SS-23-260
9 cm / 3 1/2"
1.5 mm \varnothing



SS-23-261
9 cm / 3 1/2"
2.0 mm \varnothing



SS-23-262
9 cm / 3 1/2"
2.5 mm \varnothing



SS-23-263
9 cm / 3 1/2"
3.5 mm \varnothing

SS-23-272
Suction tip



Yankauer
SS-23-264
31 cm / 12 1/4"
complete with suction tip
and connector



SS-23-268
Fig. 0
10 cm / 4"



SS-23-269
Fig. 1
10 cm / 4"



SS-23-270
Fig. 2
10 cm / 4"



SS-23-271
Fig. 3
13.5 cm / 5 1/4"



SS-23-266
15 cm / 6"
handle



SS-23-267
2.5 cm / 1"
Olive



Suction Tubes

130 mm

Cooley
BC-23-273
36 cm / 14 1/4"
8 mm ø

Cooley
BC-23-274
31 cm / 12 1/4"
10 mm ø
with perforated
screw tip

Cooley
BC-23-275
31 cm / 12 1/4"
7 mm ø
with perforated
screw tip

Cooley
BC-23-276
36 cm / 14 1/4"
8 mm ø
with perforated
screw tip

Cooley
BC-23-277
25 cm

Suction Tubes

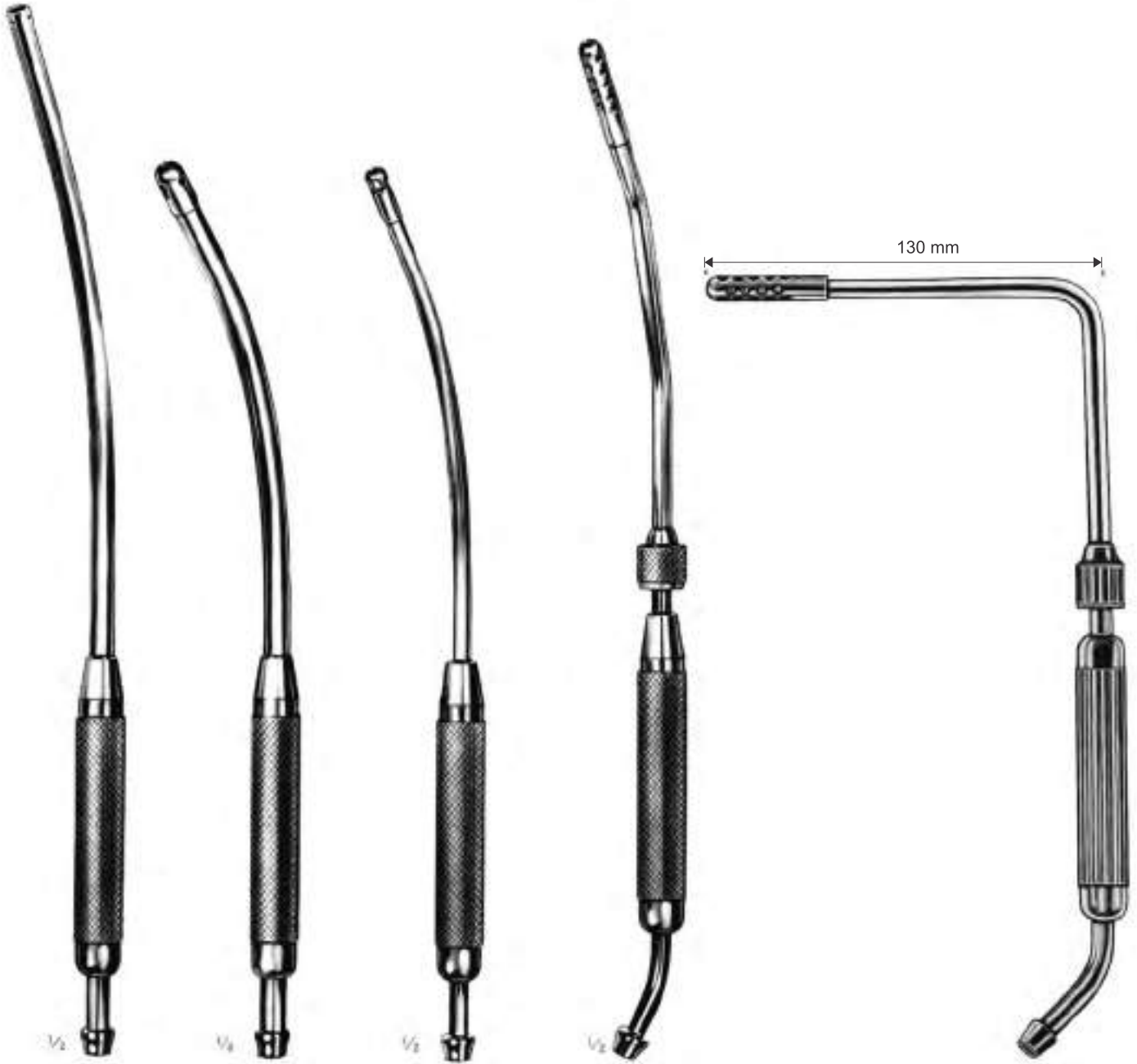

Cooley
 BC-23-273
 36 cm / 14 1/4"
 8 mm ø

Cooley
 BC-23-274
 31 cm / 12 1/4"
 10 mm ø
 with perforated
 screw tip

Cooley
 BC-23-275
 31 cm / 12 1/4"
 7 mm ø
 with perforated
 screw tip

Cooley
 BC-23-276
 36 cm / 14 1/4"
 8 mm ø
 with perforated
 screw tip

Cooley
 BC-23-277
 25 cm

Suction Tubes



Yankauer
SS-23-278
29 cm

Ø 6 mm



Andrew-Pyncheon
SS-23-279
23 cm / 9"

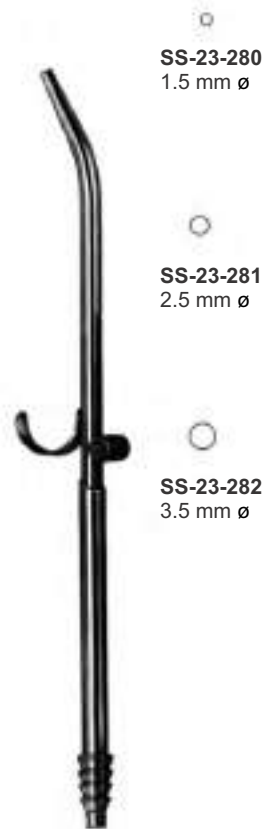

SS-23-280
1.5 mm Ø

SS-23-281
2.5 mm Ø

SS-23-282
3.5 mm Ø

Byrd
21.5 cm / 8 1/2"

Suction Tubes



Cogswell
SS-23-283
24.5 cm / 9 3/4"
2.0 mm \varnothing
with finger cut-off



Poole
SS-23-284
22 cm / 8 3/4"
10 mm \varnothing
(Charr. 30)



Poole
SS-23-285
22.5 cm / 8 3/4"
8 mm \varnothing
(Charr. 23)



**Oral
24**

24 Oral

Arnhem	200	Wolford	199,214
Bauer	201	Young	184
Bishop	181		
Brunings	183		
Collin	184		
Dautrey-munro	201		
Davis-boyle	177		
Denhart	174		
Dingmann	179,196		
Dingmann-wilk	196		
Doyen	183		
Dunn-dautrey	203		
Epker	202		
Epker-bauer	201		
Extra Oral Retractor	185		
Gillies	196		
Hargis Lip & Cheek Retractor	204		
Hargis With Chain	204,206,208		
Hargis	208		
Hartmann	182		
Heister	175		
Intra Oral Retractor	186		
Intra Oral Retractor	187		
Jaboma	216		
Jennings	180		
Jeter-van Sickels	197		
Keen	198		
Kilner-doughty	176		
Koberg, Mod.	192		
Lindemann	174		
Martin	183		
Martin-simplex	181		
Mclvor	178		
Mershon	194		
Metz	191		
Molt	175		
Molvor	178		
Mouth Gags, Cheek Retractor	180		
Obwegeser Nasal Spine	190		
Obwegeser	175,181,189,190,192,194		
Roser-konig	174		
Rowe	195		
Sakamoto	199		
Salyer	199,216		
Schuchardt	191		
Shea	188		
Shin Lift Curettes	172,173		
Smith	207		
Steinhauser Extra Long Mxy	212		
Steinhauser Reposition	211		
Steinhauser	198,211,215		
Sternberg	181		
Terry	171,209		
Tery	210		
Tobold	182		
Tongue Spatulas	183		
Turvey	209		
Wieder	182		



SS-24-101
 5.0 / 8.0 mm

Terry
 17 cm / 6 3/4"
 for elevation of alveolar flaps
 para la elevacion de las aletas alveolares
 pour elevation du lambeau alveolaire



SS-24-102
 11 cm / 4 1/4"

Terry
 Graft Packe
 Atacador de trasplantes
 Poussoir pour transplantation

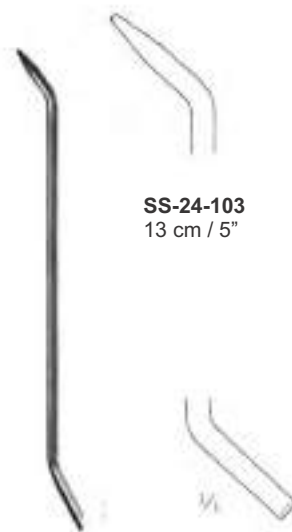

SS-24-103
 13 cm / 5"

Graft Packe
 Atacador de trasplantes
 Poussoir pour transplantation



SS-24-104
 3.0 - 7.0 mm

Terry
 18 cm / 7"
 for subperiosteal tunnels
 para tuneles subperiosticos
 pour tunnel subperiostal

Shin Lift Currettes
Curetas para sinus-lift
Currettes pour sinus-lift



SS-24-105
18 cm / 7"
2.6 / 2.6 mm



SS-24-106
17.5 cm / 7"
2.6 / 2.6 mm



SS-24-107
18 cm / 7"
4.1 / 4.1 mm



SS-24-108
18.5 cm / 7 1/4"
4.1 / 4.1 mm



SS-24-109
19 cm / 7 1/2"
6.7 / 6.7 mm



SS-24-110
18.5 cm / 7 1/4"
6.7 / 6.7 mm



SS-24-111
16 cm / 6 1/4"
2.8 / 6.2 mm



SS-24-112
16 cm / 6 1/4"
2.8 / 6.2 mm



SS-24-113
15 cm / 6"
3.1 / 3.1 mm



SS-24-114
17 cm / 5 3/4"
5.6 / 5.6 mm





SAPTESTAR
Manufacturer & Exporter Of Surgical, Dental & Veterinary Instruments

Shin Lift Currettes
Curetas para sinus-lift
Currettes pour sinus-lift

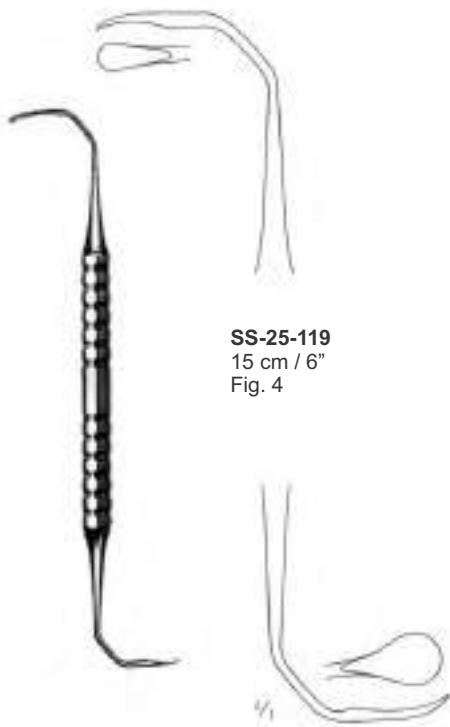
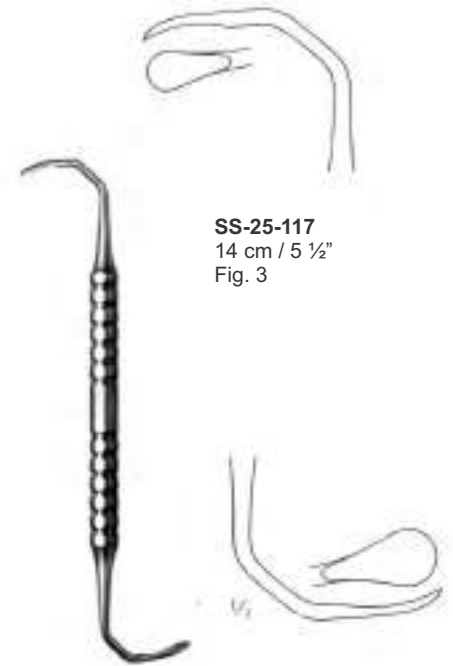
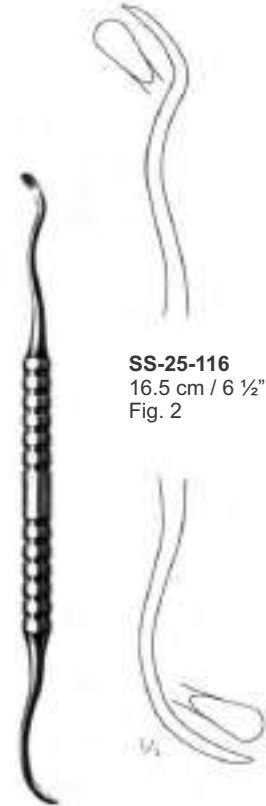



Denhart

SS-24-124
13 cm / 5"
jaw
bocas
mors
16 mm



Roser-Konig

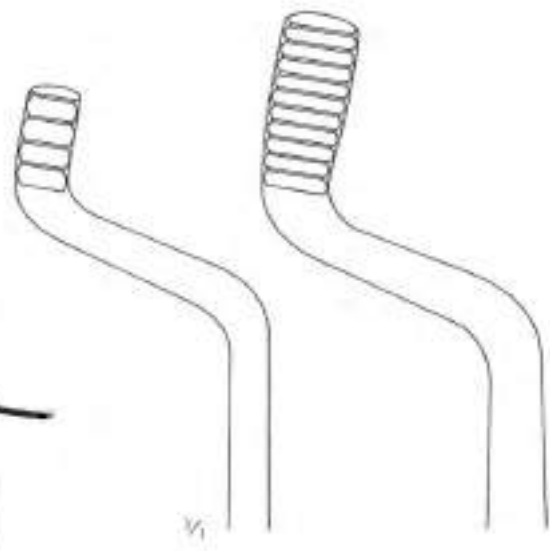

SS-24-125
16 cm / 6 1/4"

SS-24-126
20 cm / 8"

Mouth Gags
Abrebocas
Ouvert-bouche



Heistetr
SS-24-127
13 cm / 5"



Obwegeser
SS-24-128
11 cm, / 4 ¼"



Molt
SS-24-129
11 cm / 4 ¼"



Molt
SS-24-130
13 cm / 5"

Mouth Gags
Abrebocas
Ouver-bouche



Kilner-Doughty

SS-24-131
complete with frame, 3 tongue depressors
2 tooth plates and 1 palate plate
completo con bistidor, 3 bajalenguas,
2 plaquitas de dientes y 1 plaquita paladia
complete avec cadre, 3 abaisse-langue v,
2 plaques pour dents et 1 plaque palatina

SS-24-132
14.5 cm / 5 3/4"
Frame for Mouth Gag
Bastidor para abrebocha
Cadre pour ouvre-bouche

Kilner-Doughty
tongue Depressor
Bajalengua
Abaisse-langue



SS-24-133
13.5 cm / 5 1/4"
70 x 29 mm



SS-24-134
13.5 cm / 5 1/4"
80 x 34 mm



SS-24-135
13.5 cm / 5 1/4"
85 x 38 mm

Fenestrated blade for suction
hoja fenestrada para succion
lame fenetree pour aspiration

Mouth Gags
Abrebocas
Ouver-bouche



SS-24-136
complete, consisting of frame and five tongue depressors no, 1 to 5
completo, consiste de bastidor y cinco bajalenguas number 1 hasta 5
complet, dse composant de cadre et cinq abaisse-langue number 1 jusqu a 5

SS-24-137
Frame for Mouth gag
Bastidor para abreboaca
Cadre pour ouver-bouche



SS-24-139
13.5 cm / 5 1/4"
95 x 25 mm

SS-24-140
13.5 cm / 5 1/4"
80 x 24 mm

Davis-Boyle

tongue depressor
Bajalengua
Abaisse-langue

With fixed suction tube
con tubo de succion fijo
avec tube d aspiration fixe



SS-24-138
13.5 cm / 5 1/4"
110 x 26 mm

SS-24-141
13.5 cm / 5 1/4"
65 x 23 mm

SS-24-142
13.5 cm / 5 1/4"
30 x 20 mm
without suction tube
sin tubo de succion fijo
sans tube d' aspiration fixe

Mouth Gags
 Abrebocas
 Ouver-bouche



Mclvor

SS-24-143
 complete
 completo
 complet

SS-24-144
 15 cm / 6"
 Frame for Mouth Gag
 Bastidor para abreboaca
 ouver-bouche

65 x 100 mm



Mclvor
 Tongue Depressor
 Bajalengua
 Abaisse-langue

SS-24-145
 13.5 cm / 5 1/4"
 100 x 26 mm



SS-24-146
 13.5 cm / 5 1/4"
 85 x 25 mm



SS-24-146
 13.5 cm / 5 1/4"
 75 x 23 mm

Mouth Gags
Abrebocas
Ouver-bouche



SS-24-148
14.5 cm / 5 3/4"
complete with frame, 3 tongue depressors
and 2 adjustable lateral blades
complete con bastidor, 3 bajalenguasy y 2
valvas laterales ajustables
complet avec cadre, 3 abaisse-langueet 2
valves laterales réglables

Dingmann



Dingmann
Tongue depressor
Bajalengua
Abaisse-angue

SS-24-149
13.5 cm / 5 1/4"
65 x 25 mm



SS-24-150
13.5 cm / 5 1/4"
70 x 29 mm



SS-24-151
13.5 cm / 5 1/4"
80 x 32 mm

Mouth Gags, Cheek Retractors
 Abrebocas, separadores para mejilla
 Ouver-bouche, ecarteurs des joues



Jennings

- SS-24-152 10.5 cm / 4"
- SS-24-453 12.5 cm / 5"
- SS-24-154 14.5 cm / 5 ¾"
- SS-24-155 16.5 cm / 6 ½"



SS-24-156
 15 cm / 6"
 20 mm



SS-24-157
 14.5 cm / 5 ¾"
 fenestrated
 fenestrado
 fenetre

Lip & Check Retractors
Separadores para labios y mejillas
Ecarteurs deslevres et joues



Martin-Simplex
SS-24-158
10.5 cm / 4"



SS-24-159
14 cm / 5 1/2"
Vestibulum Retractor
Separador para vestibulo
Ecarteur pour vestibulum



Sternberg
SS-24-160
14 cm / 5 1/2"
26 / 37 mm

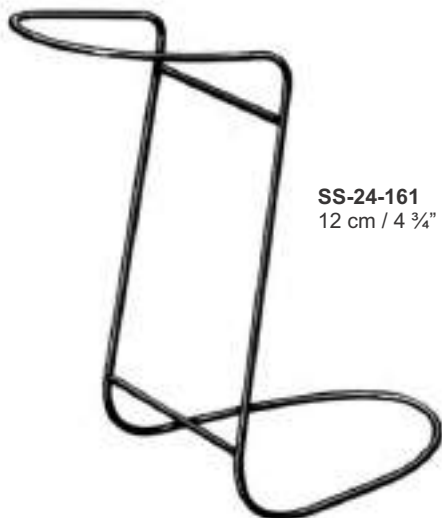

SS-24-161
12 cm / 4 3/4"

Obwegeser



SS-24-162
13.5 cm / 5 1/4"
27 mm

Bishop

Tongue Depressors
 Abajalenguas
 Abaisse-langue



Hartmann



SS-24-163
 15 cm / 6"
 72 x 23 mm



Tobold



SS-24-164
 15 cm / 6"
 88 x 25 mm



Tobold



SS-24-165
 14.5 cm / 5 3/4"
 85 x 24 mm



Wieder



SS-24-166
 14 cm / 5 1/2"
 36 mm



SS-24-167
 15 cm / 6"
 43 mm

Tongue Spatulas
Espatulas linguales
Abaisse-langue



SS-24-168
16 cm / 6 ¼"
package of 100 pieces wood
paquete con 100 piezas madera
paquet de 100 pieces
bois



SS-24-169
15 cm / 6"
package of 100 pieces plastic
paquete con 100 piezas plastico
paquet de 100 pieces
plastique



SS-24-170
18.5 cm / 7 ½"
nylon
nilon
nylon

Martin



Doyen



SS-24-171
13.5 cm / 5 ¼"
24 / 30 mm



SS-24-172
16 cm / 6 ¼"
30 / 34 mm



Bruning

SS-24-173
19 cm / 7 ½"
19 / 15 mm

Tongue Holding Forceps
Pinzas tira-lengua
Pinces tire-langue



SS-24-174
17 cm / 6 3/4"
jaw 24 x 27 mm
boca 24 x 27 mm
mors 24 x 27 mm

Collin



SS-24-175
15 cm / 6"

Young



Young
SS-24-176
23 x 15 mm
rubber inserts
Bocas de goma
Mors en acoutchouc
Pair
par
paire

Extra Oral Retractors
Separadors extra orales
Retracteurs extra-oraux



SS-24-177
22 cm / 8 3/4"
9.5 mm / 16 mm
concave blade, fully bent tip
hoja concava, fuertemente curva
lame concave, courbe enormement



SS-24-179
23 cm / 9"
25.5 mm
for LeFort osteotomies
para osteotomias segun LeFort
Pour osteotomis selonLeFort

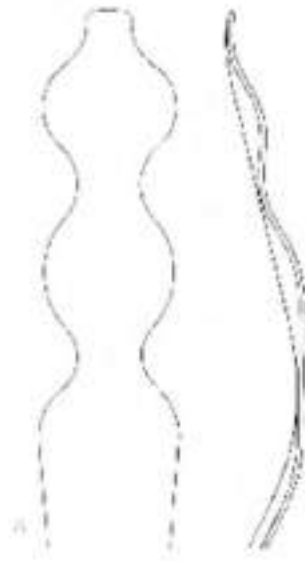

Intra Oral Retractors
Separadores intraorales
Retracteurs intra-oraux

With fiber optic light carrier. Con conexion de luz fria. Avec connection lumiere froide

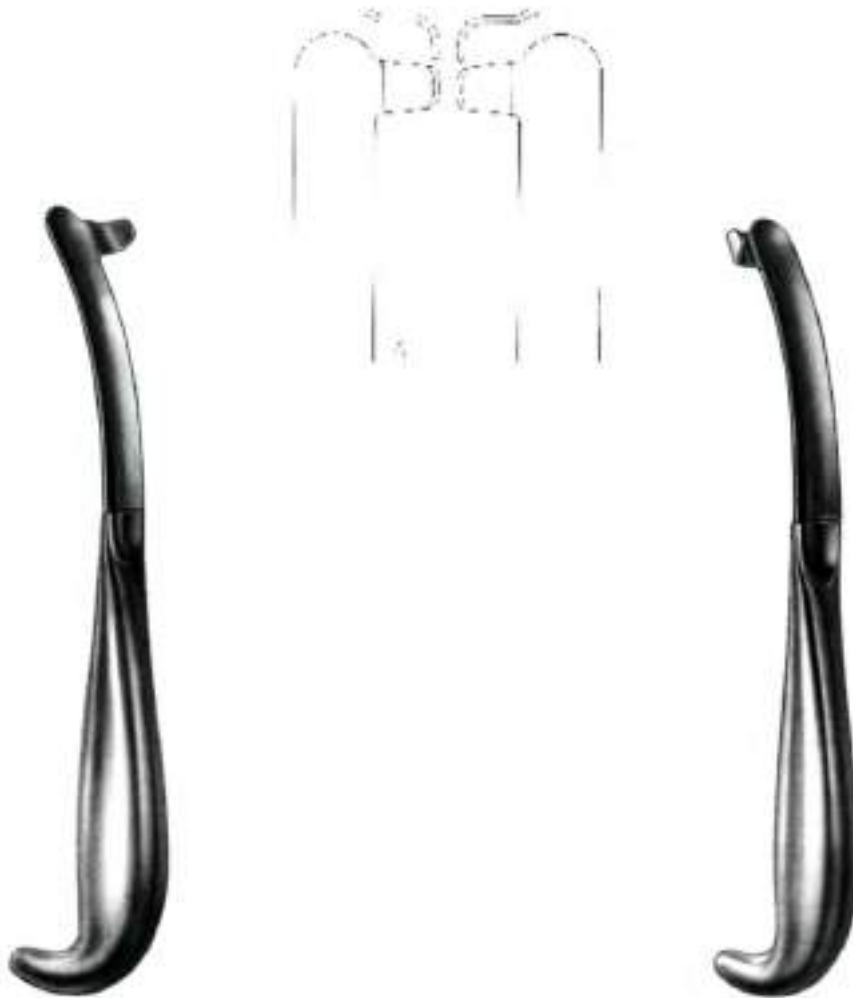

SS-24-181
21 cm / 8 ¼"
26.5 / 16 mm
right
derecha
droite

SS-24-182
21 cm / 8 ¼"
26.5 / 16 mm
left
izquierdo
gauche

Intra Oral Retractors
Separadores intraorales
Retracteurs intra-oraux

With fiber optic light carrier. Con conexion de luz fria. Avec connection lumiere froide



SS-24-185
25 cm / 9 3/4"
12.5 - 27 mm
L&M, for vertical osteotomy
L&M, paraosteotomia vertical
L&M, pour osteotomie verticale

SS-24-186
28 cm / 11"
12.5 - 27 mm
L&M, for vertical osteotomy
L&M, paraosteotomia vertical
L&M, pour osteotomie verticale

Soft Tissue Retractors
Separadores para partes blandas
Crochets pour parties molles

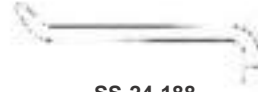

SS-24-188
21.5 cm / 8 1/2"
43 x 11 mm



SS-24-189
21.5 cm / 8 1/2"
57 x 11 mm



SS-24-190
21.5 cm / 8 1/2"
83 x 16 mm



Obwegeser

Ramus Retractors
Separadores para el ramo
Ecarteurs pour ramus

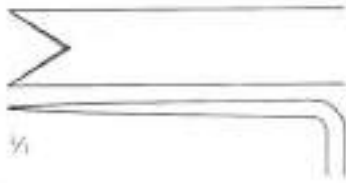

Obwegeser

SS-24-191
22 cm / 8 3/4"
Nasal Spine Retractor
Separador para spine nasalis
Ecarteur pour spina nasalis

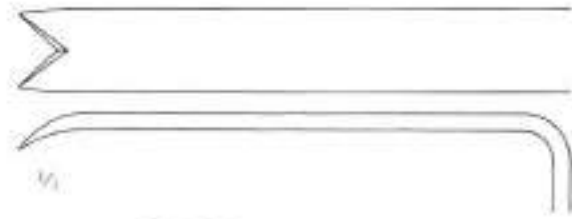

Obwegeser

SS-24-192
22 cm / 8 3/4"
72 x 10 mm

Progeny Retractors
Separadores para progenismo
Crochet de prognie

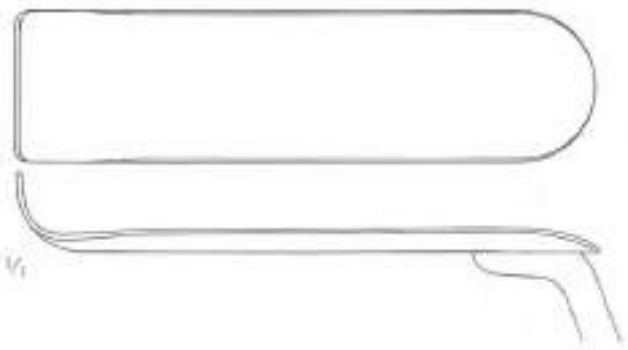

SS-24-193
15 cm / 6"



Schuchardt

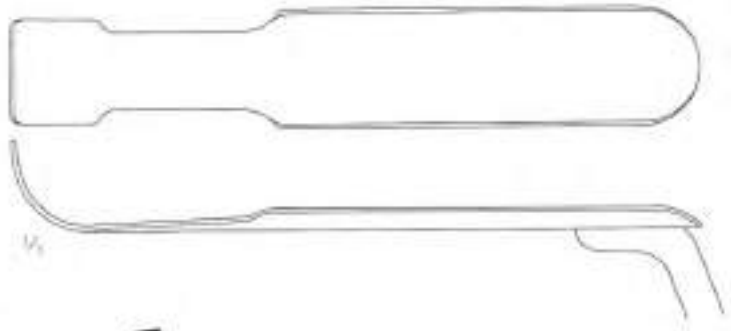

SS-24-194
15 cm / 6"



Metz

Retractors, Periosteal Elevators
Separadores, legas
Ecarteurs, rugines-raspatoires



Obwegeser
SS-24-195
16.5 cm / 6 1/2"



Obwegeser
SS-24-196 17 cm / 6 3/4" 8 mm
SS-24-197 17 cm / 6 3/4" 10 mm



SS-24-198
18.5 cm / 7 1/4"
14 x 7 mm



Koberg, mod.
SS-24-199
18.5 cm / 7 1/4"
20 x 7 mm



SS-24-200
18 cm / 7"
3 x 18 mm



SS-24-201
18 cm / 7"
3.5 x 23 mm



SAPTESTAR
Manufacturer & Exporter Of Surgical, Dental & Veterinary Instruments

Periosteal Elevators
Legras
Rugines-raspatoires



Obwegeser



SS-24-202
17.5 cm / 7 "
6 mm



SS-24-203
17.5 cm / 7 "
7 mm



SS-24-204
17.5 cm / 7 "
9 mm



SS-24-205
17.5 cm / 7 "
11 mm



Obwegeser



SS-24-206
20.5 cm / 8 "
5 mm



SS-24-207
20.5 cm / 8 "
7 mm



SS-24-208
20.5 cm / 8 "
9 mm

Periosteal Elevators
Legras
Rugines-raspatoires

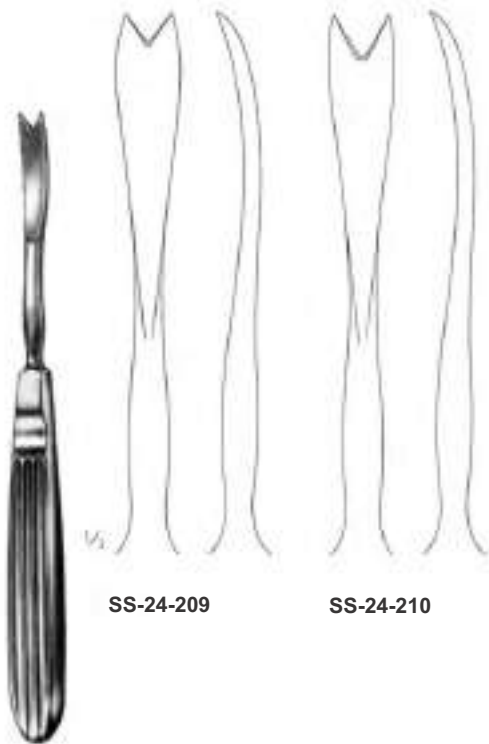

SS-24-209

SS-24-210

Obwegeser
17.5 cm / 7 "

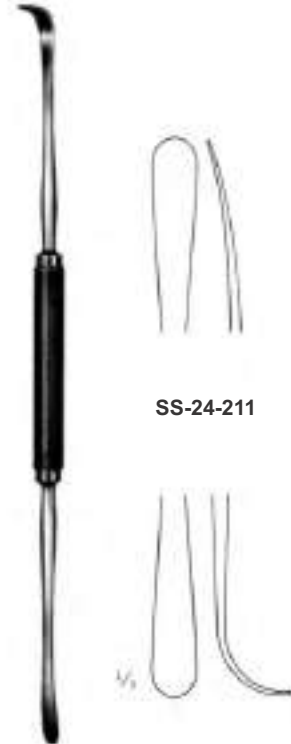

SS-24-211

Obwegeser
20.5 cm / 8 "



SS-24-212

Obwegeser
20.5 cm / 8 "

Wire Pushers - Empujadores de alambres - Outil de positionnement



SS-24-213
17 cm / 6 3/4"



SS-24-214
15 cm / 6"



Rowe



SS-24-215
15 cm / 6"



Mershon

Disimpaction Forceps
 Pinzas para reposicion
 Pincas de reposicion



SS-24-216 L
 SS-24-217 R

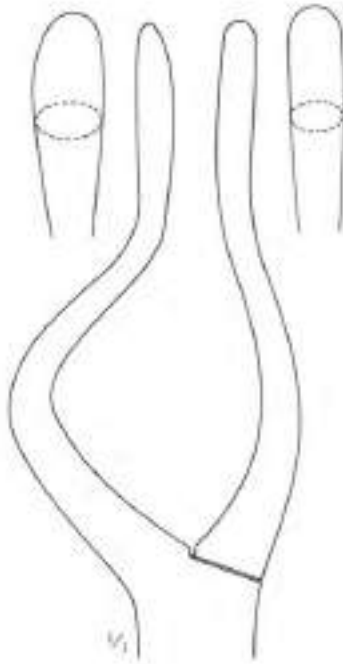

SS-24-218 L
 SS-24-219 R

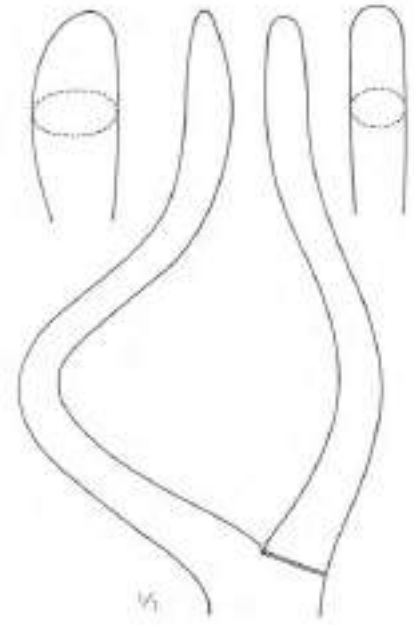

SS-24-220 L
 SS-24-221 R



Rowe
 22.5 cm / 9"
 left
 izquierdo
 gauche
 L



Rowe
 24 cm / 9 1/2"
 right
 derecha
 droite
 R

Zygoma Elevators, Retractors
 Elevadores cigomaticos, Separadores
 Elevateurs zygomatiques, Ecarteurs



Gillies
 20 cm / 8"



SS-24-222



Dingmann
 21 cm / 8 ¼"

SS-24-223
 5.0 mm ø
 tip
 punta
 pointe



Dingmann-Wilk
 20 cm / 8"



SS-24-224

Bone Holding Forceps
Pinzas para huesos
Pinces pour os

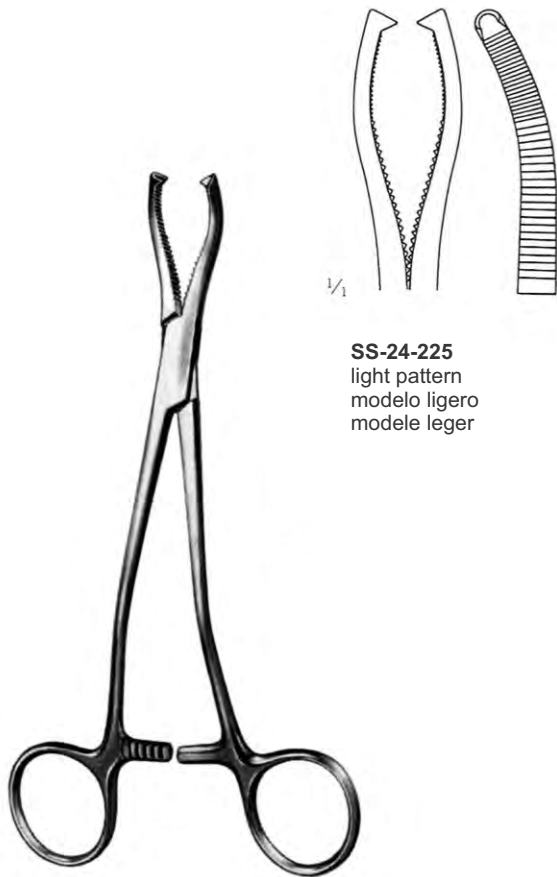

SS-24-225
light pattern
modelo ligero
modele leger

Jeter-Van Sickers
18 cm / 7"
for sagittal split procedure
para uso en el sagital split
pour fente sagittale

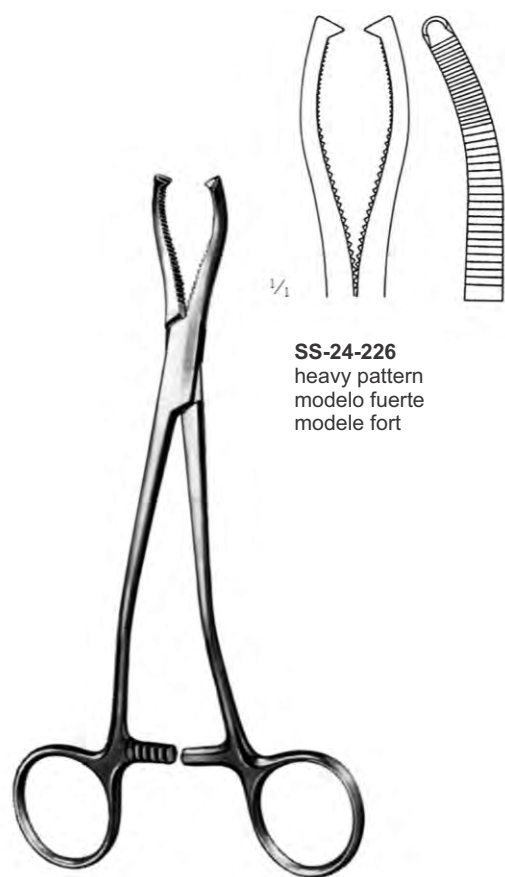

SS-24-226
heavy pattern
modelo fuerte
modele fort

Jeter-Van Sickers
18 cm / 7"
for sagittal split procedure
para uso en el sagital split
pour fente sagittale

Bone Holding Forceps
Pinzas para huesos
Pinces pour os



Keen
17.5 cm / 6 ¾"



SS-24-227
left
izquierdo
gauche

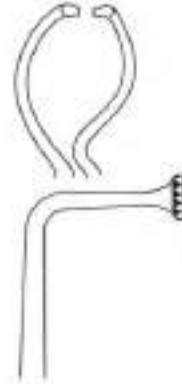

SS-24-228
right
derecha
droite



Steinhauser
SS-24-229
13 cm / 5"



Steinhauser
SS-24-230
13 cm / 5"

Bone Holding Forceps
Pinzas para huesos
Pinces pour os



SS-24-231
25 cm / 10"

Welford



SS-24-232
16 cm / 6 1/2"

Salyer



Sakamoto
SS-24-233
14 cm / 5 1/2"
Measuring Forceps
Pinzas para medir
Pincs pour mesurer

Lefort I Retractors, sinus Lift Retractors
Ganchos de lafort I, gancho para seno
Crochets de lefort I, crochet pour sinus

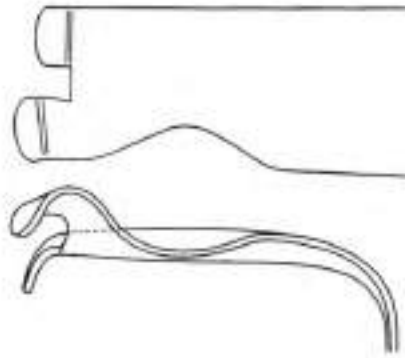

SS-24-234
left
iaquierdo
gauche

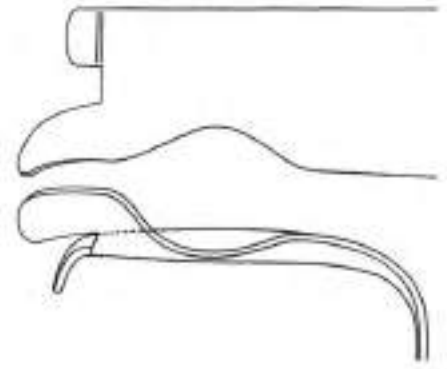

SS-24-235
left
iaquierdo
gauche

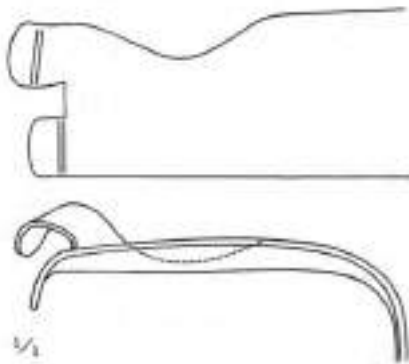

SS-24-236
right
derecha
droite

Arnhem
22 cm / 8 3/4"
LeFort I Retractor
Gancho de LeFort I
Crochet de LeFort I

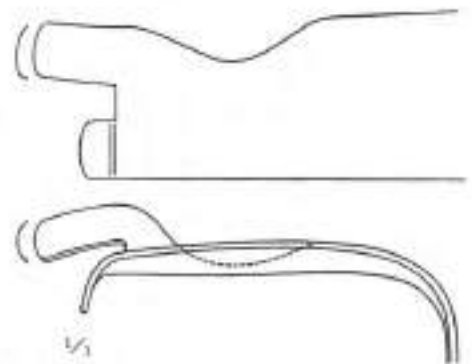

SS-24-237
right
derecha
droite

Arnhem
22 cm / 8 3/4"
Sinus lift Retractor
Gancho para seno
Crochet pour sinus



SAPTESTAR
Manufacturer & Exporter Of Surgical, Dental & Veterinary Instruments

Osteotomes
Osteotomes
Osteotomos

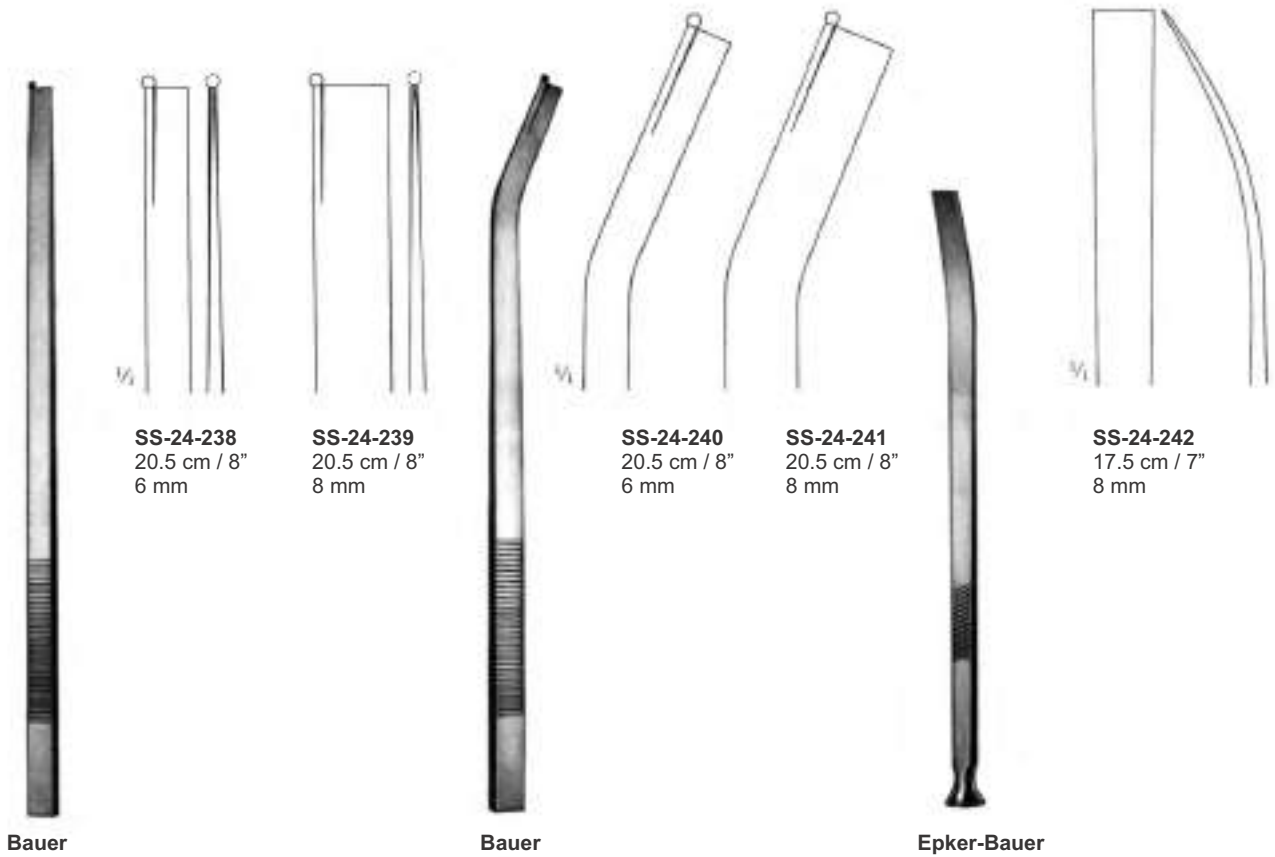

SS-24-238
20.5 cm / 8"
6 mm

SS-24-239
20.5 cm / 8"
8 mm

SS-24-240
20.5 cm / 8"
6 mm

SS-24-241
20.5 cm / 8"
8 mm

SS-24-242
17.5 cm / 7"
8 mm

Bauer

Bauer

Epker-Bauer

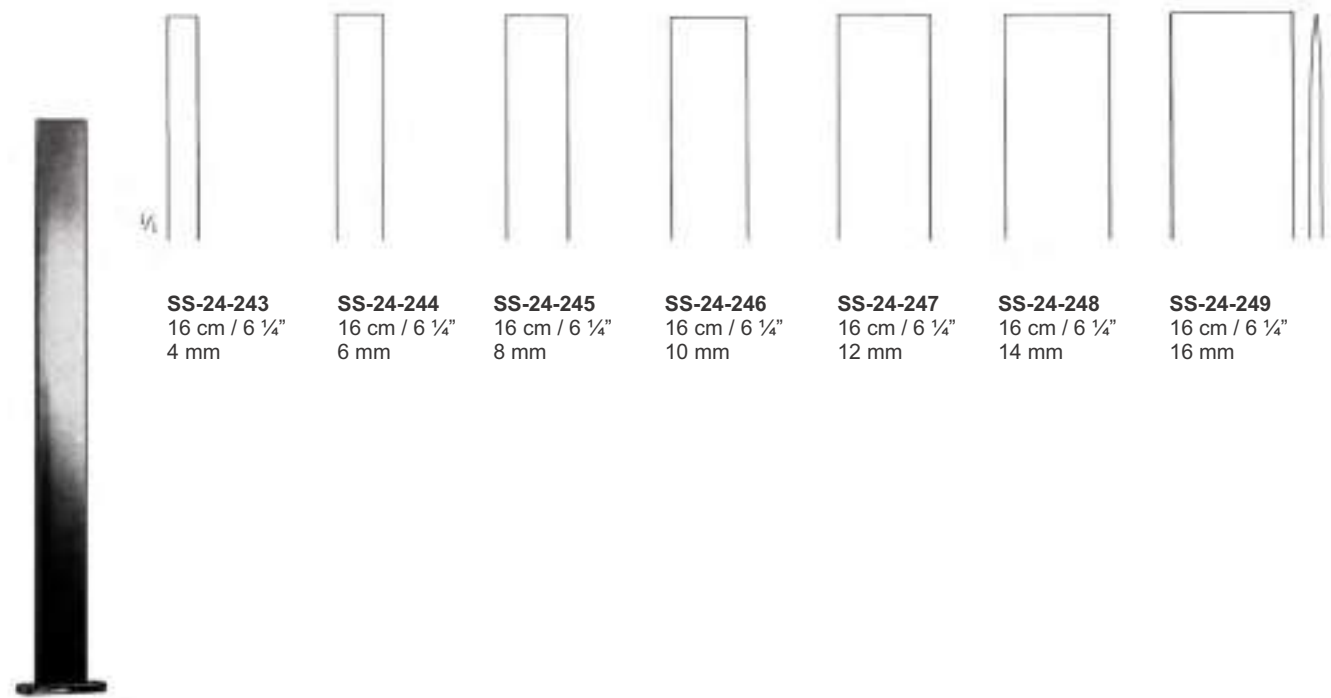

SS-24-243
16 cm / 6 1/4"
4 mm

SS-24-244
16 cm / 6 1/4"
6 mm

SS-24-245
16 cm / 6 1/4"
8 mm

SS-24-246
16 cm / 6 1/4"
10 mm

SS-24-247
16 cm / 6 1/4"
12 mm

SS-24-248
16 cm / 6 1/4"
14 mm

SS-24-249
16 cm / 6 1/4"
16 mm

Dautrey-Munro

Osteotomes
 Osteotomes
 Osteotomos

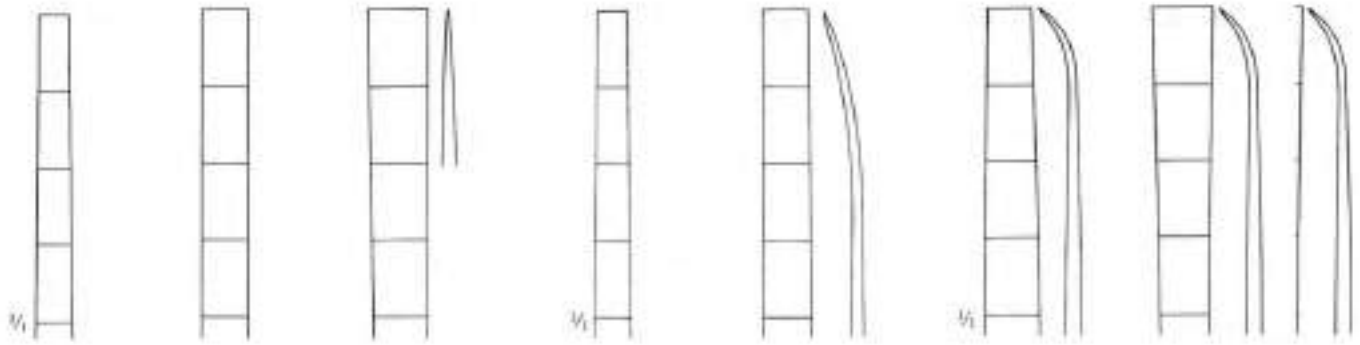

SS-24-250
 18 cm / 7"
 4 x 1.2 mm

SS-24-251
 18 cm / 7"
 6 x 1.2 mm

SS-24-252
 18 cm / 7"
 8 x 1.2 mm

SS-24-253
 18 cm / 7"
 4 x 1.2 mm

SS-24-254
 18 cm / 7"
 6 x 1.2 mm

SS-24-255
 18 cm / 7"
 6 x 1.2 mm

SS-24-256
 18 cm / 7"
 8 x 1.2 mm



Epker



Epker



Epker

Osteotomes
Osteotomes
Osteotomos



1/4

SS-24-257
16.5 cm / 6 1/2"
4 mm



SS-24-258
16.5 cm / 6 1/2"
6 mm



SS-24-259
16.5 cm / 6 1/2"
8 mm



1/4

SS-24-260
17 cm / 6 3/4"
6 mm



SS-24-261
17 cm / 6 3/4"
6 mm

Dunn-Dautrey

Dunn-Dautrey

Ramus Retractors
Separadores de rama
Ecarteurs pour ramus

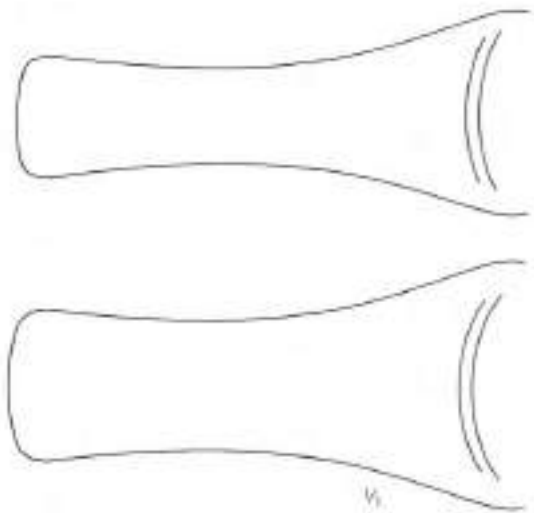

SS-24-262
16 cm / 6 1/4"

Hargis
Lip and Cheek Retractors
Separadores para labios y mejillas
Ecarteurs pour levres et joues



Hargis



SS-24-263
19.5 cm / 7 3/4"
right
derecha
droite

SS-24-264
19.5 cm / 7 3/4"
left
izquierdo
gauche

Mandibular Body Retractors
Separadores para el cuerpo mandibular
Ecarteurs pour corps mandibulaire



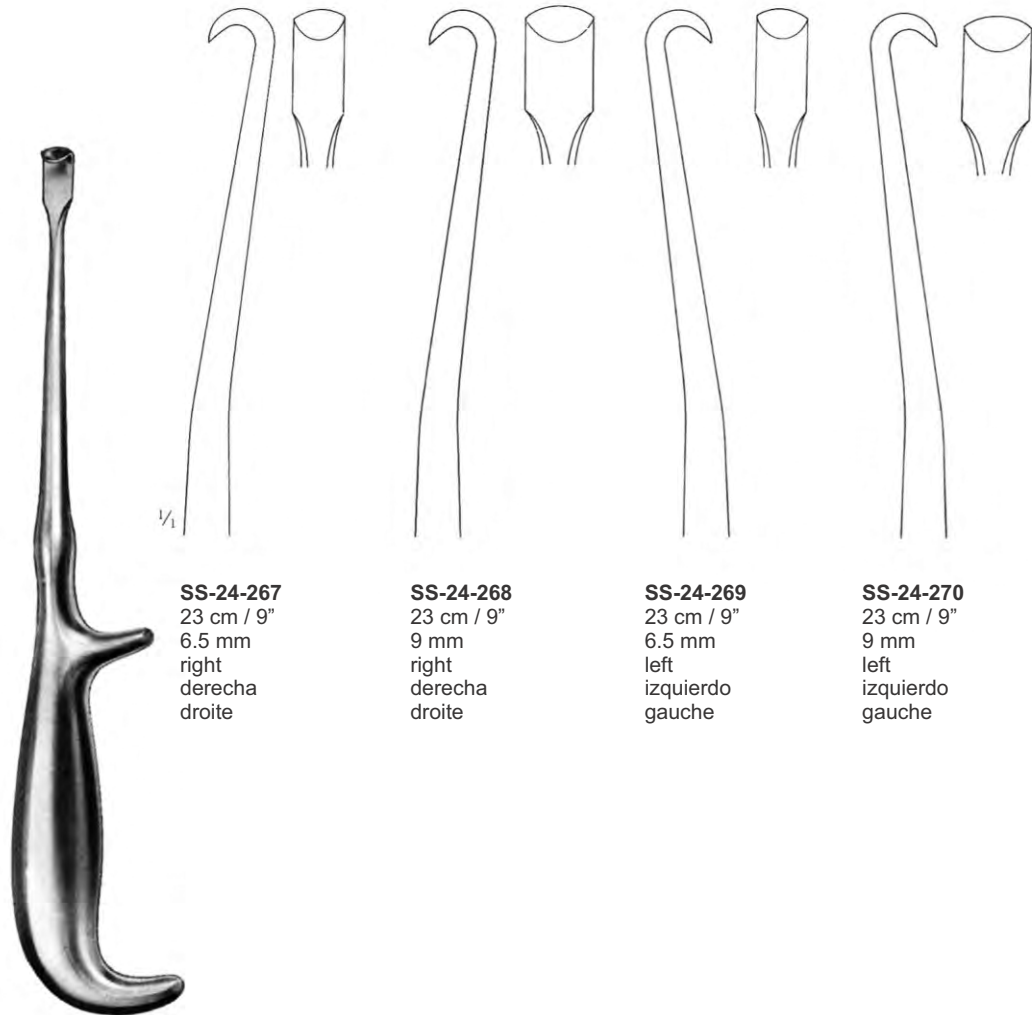

SS-24-267
 23 cm / 9"
 6.5 mm
 right
 derecha
 droite

SS-24-268
 23 cm / 9"
 9 mm
 right
 derecha
 droite

SS-24-269
 23 cm / 9"
 6.5 mm
 left
 izquierdo
 gauche

SS-24-270
 23 cm / 9"
 9 mm
 left
 izquierdo
 gauche

Hargis

Micro-Surgery Instruments with Finger Grip Handles
Instrumentos-Micro con mango de moldear a mano
Micro instruments avec poignee



Micro Scissors
Micro Tijeras
Micro-ciseaux



Micro Forceps
Micro Pinzas
Micro-Pinces

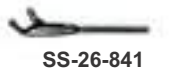
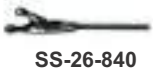

Cup-Shaped Forceps
Pinzas en forma de cuchara
Pinzes bec de canard



SAPTESTAR

Manufacturer & Exporter Of Surgical, Dental & Veterinary Instruments



+92-340-4040061



exportsaptestar@gmail.com



info@saptestar.com



www.saptestar.com



Defence Road, Near Hotel Javson, 51310-Sialkot Pakistan

